

AUTODESK®
3DS MAX® 
8

Tutorial Guide

Volume I

Autodesk®

Copyright © 2005 Autodesk, Inc. All rights reserved.

This publication, or parts thereof, may not be reproduced in any form, by any method, for any purpose.

AUTODESK, INC., MAKES NO WARRANTY, EITHER EXPRESS OR IMPLIED, INCLUDING BUT NOT LIMITED TO ANY IMPLIED WARRANTIES OF MERCHANTABILITY OR FITNESS FOR A PARTICULAR PURPOSE REGARDING THESE MATERIALS, AND MAKES SUCH MATERIALS AVAILABLE SOLELY ON AN "AS-IS" BASIS.

IN NO EVENT SHALL AUTODESK, INC., BE LIABLE TO ANYONE FOR SPECIAL, COLLATERAL, INCIDENTAL, OR CONSEQUENTIAL DAMAGES IN CONNECTION WITH OR ARISING OUT OF PURCHASE OR USE OF THESE MATERIALS. THE SOLE AND EXCLUSIVE LIABILITY TO AUTODESK, INC., REGARDLESS OF THE FORM OF ACTION, SHALL NOT EXCEED THE PURCHASE PRICE OF THE MATERIALS DESCRIBED HEREIN.

Autodesk, Inc., reserves the right to revise and improve its products as it sees fit. This publication describes the state of this product at the time of its publication, and may not reflect the product at all times in the future.

Autodesk Trademarks

The following are registered trademarks of Autodesk, Inc., in the USA and other countries: 3D Studio, 3D Studio MAX, 3D Studio VIZ, 3ds Max, ActiveShapes, Actrix, ADI, AEC-X, ATC, AUGI, AutoCAD, AutoCAD LT, Autodesk, Autodesk Envision, Autodesk Inventor, Autodesk Map, Autodesk MapGuide, Autodesk Streamline, Autodesk WalkThrough, Autodesk World, AutoLISP, AutoSketch, Backdraft, Biped, Bringing information down to earth, Buzzsaw, CAD Overlay, Character Studio, Cinepak, Cinepak (logo), Civil 3D, Cleaner, Codec Central, Combustion, Design Your World, Design Your World (logo), EditDV, Education by Design, Gmax, Heidi, HOOPS, Hyperwire, i-drop, IntroDV, Lustre, Mechanical Desktop, ObjectARX, Physique, Powered with Autodesk Technology (logo), ProjectPoint, RadioRay, Reactor, Revit, VISION*, Visual, Visual Construction, Visual Drainage, Visual Hydro, Visual Landscape, Visual Roads, Visual Survey, Visual Toolbox, Visual Tugboat, Visual LISP, Volo, WHIP!, and WHIP! (logo).

The following are trademarks of Autodesk, Inc., in the USA and other countries: AutoCAD Learning Assistance, AutoCAD Simulator, AutoCAD SQL Extension, AutoCAD SQL Interface, AutoSnap, AutoTrack, Built with ObjectARX (logo), Burn, Buzzsaw.com, CAiCE, Cinestream, Cleaner Central, ClearScale, Colour Warper, Content Explorer, Dancing Baby (image), DesignCenter, Design Doctor, Designer's Toolkit, DesignKids, DesignProf, DesignServer, Design Web Format, DWF, DWFit, DWG Linking, DXF, Extending the Design Team, GDX Driver, Gmax (logo), Gmax ready (logo), Heads-up Design, Incinerator, jobnet, ObjectDBX, Plasma, PolarSnap, Productstream, Real-time Roto, Render Queue, Topobase, Tokik, Visual Bridge, and Visual Syllabus.

Autodesk Canada Co. Trademarks

The following are registered trademarks of Autodesk Canada Co. in the USA and/or Canada and other countries: Discreet, Fire, Flame, Flint, Flint RT, Frost, Glass, Inferno, MountStone, Riot, River, Smoke, Sparks, Stone, Stream, Vapour, Wire.

The following are trademarks of Autodesk Canada Co., in the USA, Canada, and/or other countries: Backburner, Multi-Master Editing.

Third-Party Trademarks

All other brand names, product names or trademarks belong to their respective holders.

Third-Party Software Program Credits

© 2005 Microsoft Corporation. All rights reserved.

ACIS © 1989–2005, Spatial Corp.

AddFlow Copyright © 1997–2005 Lassalle Technologies.

Certain patents licensed from Viewpoint Corporation.

clothfx is a trademark of Size8 Software, Inc.

OpenEXR Bitmap I/O Plugin © 2003–2005 SplutterFish, LLC

OpenEXR © 2003 Industrial Light and Magic a division of Lucas Digital Ltd. LLC

Portions Copyrighted © 2000–2005 Joseph Alter, Inc.

Licensing Technology Copyright © Macrovision Corp. 1996–2005.

Portions Copyrighted © 1989–2005 mental images GmbH & Co. KG Berlin, Germany.

Portions Copyrighted © 2000–2005 Telekinesys Research Limited.

Portions Copyrighted © 2005 Blur Studio, Inc.

Portions Copyrighted © 2005 Intel Corporation.

Portions developed by Digimation, Inc. for the exclusive use of Autodesk, Inc.

Portions developed by Lyric Media, Inc. for the exclusive use of Autodesk, Inc.

Portions of this software are based on the copyrighted work of the Independent JPEG Group.

JSR-184 Exporter Copyright (c) 2004 Digital Element, Inc.

QuickTime © 1992–2005, Apple Computer, Inc.

REALVIZ Copyright © 2005 REALVIZ S.A. All rights reserved.

ZLib © 1995–2003 Jean-loup Gaily and Mark Adler

This product includes Radiance software (<http://radsite.lbl.gov/radiance>) developed by the Lawrence Berkeley National Laboratory

(<http://www.lbl.gov>). Copyright © 1990–2005 The Regents of the University of California, through Lawrence Berkeley National Laboratory. All rights reserved.

Wise Installation System for Windows Installer © 2004 Wise Solutions, Inc. All rights reserved.

GOVERNMENT USE

Use, duplication, or disclosure by the U.S. Government is subject to restrictions as set forth in FAR 12.212 (Commercial Computer Software-Restricted Rights) and DFAR 227.7202 (Rights in Technical Data and Computer Software), as applicable.

toc

Contents

1	Introduction	1	Using the Editable Poly Tools.....	80
	Welcome to the World of 3ds Max	1	Using Soft Selection.....	85
	Where to Find Tutorial Files.....	3	Using the HSDS Modifier.....	89
	How to Learn 3ds Max	3	Using the Edit Normal Modifier	90
	Working with the Tutorials Online	4	Modeling a Head with NURBS	92
	User Showcase	6	Modeling a Head with NURBS	92
2	Welcome to 3ds Max 8	11	Creating Contours for the Head.....	93
	New to 3D.....	11	Previewing the Head	97
	What's New in 3ds Max 8	13	Creating the Eye.....	98
	Game Design	14	Creating the Ear.....	101
	Design & Visualization.....	16	Mirroring and Lofting the Head	102
	Film & TV Effects.....	17	Completing the Head	105
3	Getting Started	21	Modeling an Apple	106
	Modeling	21	Modeling an Apple	106
	Modeling a Chess Set	21	Creating the Basic Apple Shape.....	107
	Modeling a Chess Set	21	Improving the Shape of the Apple	108
	Modeling a Pawn	21	Completing the Apple	110
	Modeling a Bishop.....	29	Adding a Stem to the Apple.....	112
	Modeling a Rook.....	31	Materials & Mapping	114
	Modeling a Knight.....	35	Introduction to Materials & Mapping	114
	Modeling an Airplane	46	Introduction to Materials and Mapping	114
	Modeling an Airplane	46	Accessing Materials	115
	Setting Up the Airplane Scene	47	Assigning Materials to Objects	118
	Setting Up Viewport Backgrounds	48	Creating Basic Materials.....	119
	Creating the Wings.....	51	Understanding Ambient Color and Light.....	122
	Adding the Stabilizer and Rudders	57	Creating Transparency	123
	Creating the Sponsons.....	61	Understanding Shaders	125
	Creating the Gondola.....	68	Mapping and Mapping Coordinates.....	128
	Finishing the Plane	76	Creating Multi/Sub-Object Materials	136
	Refining the Airplane	78	Using Raytrace Materials and Maps	139
	Refining the Airplane	78	Texturing the Chessboard	141
	Using the Vertex Weld Modifier	79	Using Displacement Mapping with Surface Properties.....	144
			Adding Stars to the Sky	148

Creating a Skin Material.....	151	Animating a Pen	262
Materials for Interior Scenes	155	Animating a Pen	262
Materials for Interior Scenes	155	Drawing the Path on the Paper	262
Materials of One Color: Applying Standard Materials	155	Animating the Pen on the Path	265
Adding Complexity: Applying Mapped Materials..	159	Creating the Line Using PathDeform.....	267
Applying Multiple Materials to One Object.....	162	Working with Animation Tracks	270
Creating 3D Materials: Another Approach to Wood	166	Working with Animation Tracks	270
Using an Architectural Material on the Wall	169	Animating a Walkthrough	276
Material Combinations: Using Blend to Create a Floor Material	174	Animating a Walkthrough	276
Using the UVW Map Modifier to Adjust the Floor Tiles	180	Creating a Walkthrough.....	276
Using Map Scaler	181	Biped Animation.....	281
Using the MapScaler Modifiers.....	181	Biped Quickstart.....	281
Applying Uniform Textures to Different-Sized Objects.....	181	Quick Start	281
Applying Uniform Textures to Complex Objects ...	186	Creating a Biped	282
Using the Object-Space MapScaler Modifier.....	189	Posing a Biped	283
Managing Texture Coordinates.....	192	Applying Physique	288
Managing Texture Coordinates.....	192	Animating the Biped with Freeform Animation ...	291
Using Unwrap UVW, Part 1	193	Animating the Biped with Footsteps	294
Using Unwrap UVW, Part 2	195	Combining Motions with the Motion Mixer	299
Using Unwrap UVW, Part 3	199	Animating with Footsteps	302
Using the Relax Tool on Texture Coordinates.....	202	Animating with Footsteps.....	302
Using the Channel Info Utility	204	Creating a Distinctive Walk	303
Ink & Paint.....	215	Modifying Footsteps	312
Ink 'n Paint Material.....	215	Making a Biped Stop and Start Walking.....	317
Translucent Shading	221	Animating a Gymnastic Flip	319
Translucent Shading.....	221	Animating a Pratfall	332
Animation	223	Changing Footsteps Using IK Keys.....	341
Animating with Auto Key.....	223	Animating with Freeform	343
Bouncing a Ball.....	223	Animating with Freeform	343
Creating Animation Using Auto Key	224	Creating a Simple Freeform Animation.....	344
Controlling In-Betweens	227	Animating a Freeform Walk Cycle	359
Adding Parameter Curve Out-of-Range Types	229	Using Controllers with Biped.....	375
Animating with Dummy Objects.....	230	Creating Animated Bones with Biped.....	380
Using the Dope Sheet Editor	236	Adjusting the Biped to the Model	382
Using Weighted List Controllers	237	Getting Started with Physique	382
Adding Squash and Stretch with Modifiers	240	Working with Biped Parts	383
Flying a Spacefighter	241	Aligning the Biped to the Model.....	386
Flying a Spacefighter	241	Applying the Physique Modifier	396
Adding and Adjusting Flight Paths	242	Adjusting Envelopes.....	400
Animating the Spacefighter with Constraints and Controllers.....	246	Fixing Shoulders and Hips	404
Taking Control of Mars, Its Moons, and the Space Station.....	255	Rendering.....	409
Animating the Spaceship Using XRefs.....	259	Introduction to Lighting	409
		Introduction to Lighting	409
		Lighting an Interior Space.....	410
		Lighting a Close-Up of a Head.....	415
		Managing Multiple Lights	419
		Choosing a Shadow Type	422
		Introduction to Rendering.....	424
		Introduction to Rendering.....	424

Rendering Still Images	425
Rendering an Animation	432
Creating an Animated Shadow Study	434
Advanced Lighting and Global Illumination	437
Advanced Lighting and Global Illumination	437
Creating a Radiosity Solution	438
Speeding Up Rendering	441
Adjusting the Quality of Radiosity	443
Changing How Objects Behave Under Global Illumination	446
Rendering a Daylight Scene	448
Using Radiosity with Standard Lights	452
Rendering a Panorama.....	455
Rendering a Panorama	455
F/X.....	457
Particles.....	457
Creating Cigarette Smoke.....	457
Creating an Explosion with Fragments and Bubbles.....	464
Modeling Whipped Cream.....	473
Modeling Whipped Cream	473
Lens Effects	474
Creating the Sun with a Lens Flare.....	474
Adding a Camera View	475
Adding Lights	476
Adding a Glow to the Sun Using Lens Effects.....	477
Adding a Ring Effect	479
Adding a Star Effect.....	480
Adding Another Glow.....	481
Index	483

1

Introduction

Welcome to the World of 3ds Max

Welcome, and congratulations! You've just bought a ticket to the world of Autodesk® 3ds Max® 8. Hang on and get ready for the ride of a lifetime! With 3ds Max, you can create 3D places and characters, objects and subjects of any type. You can arrange them in settings and environments to build the scenes for your movie or game or visualization. You can animate the characters, set them in motion, make them speak, sing and dance, or kick and fight. Then, shoot movies of the whole virtual thing.

You can use 3ds Max to visualize designs of real things that will actually be built, such as buildings and machines. The File Link feature of 3ds Max lets you base visualizations on designs created in AutoCAD or Autodesk Architectural Desktop: when the design changes in these other applications, the revisions can be automatically updated in your 3ds Max scene. Add lighting and materials, then render to still image or movie formats.

These tutorials teach 3ds Max through a series of hands-on exercises. Prepare to be entertained and fascinated by the awesome power at your fingertips.

Who the Tutorials Are for and How to Use Them

Here is a strategy guide to point you directly to the right tutorials for your needs.

If You've Never Used a 3D Program Before

Maybe you are new to the whole idea of creating 3D models and animation on the computer. If so, read the *Getting Started with 3ds Max* chapter of the [3ds Max 8 User Reference](#). This chapter contains fairly brief conceptual sections that introduce the ideas and terminology you need to understand to use 3ds Max. You can read this chapter online, by choosing User Reference from the Help menu.

Once you have familiarized yourself with the concepts of 3D modeling and animation, move on to the first of these tutorials, which will introduce your hands and mind to the basic concepts of working in 3D and using the program.

Once you have familiarized yourself with the concepts of 3D modeling and animation, move on to the online tutorials that are appropriate to your interests. You access the online tutorials by choosing Tutorials from the Help menu.

It might also help to read the *3ds Max 8 New Features Guide*, the printed booklet that comes with the program.

If You Are Skilled in A Different 3D Program

Read the *3ds Max 8 New Features Guide*, the printed booklet that comes with the software. Then read the *Getting Started with 3ds Max* chapter of the [3ds Max 8 User Reference](#). This chapter contains fairly brief conceptual sections that introduce the ideas and terminology you need to understand to use 3ds Max. You can read this chapter online, by choosing User Reference from the Help menu. Then look at reference topics and tutorials related to the work you plan to do, so that you can get a feel for the 3ds Max user interface and workflow.

If You Are Upgrading from an Earlier Version of 3ds Max

Read the *3ds Max 8 New Features Guide*, the printed booklet that comes with the software. Then read [What's New in 3ds Max 8](#) in the *User Reference*. Finally, try your hand at some of the new feature tutorials. See What's New in 3ds Max 8 in the online Tutorials.

For another list of new features, in either the *Reference* or the *Tutorials*, go to the Index panel of the Help Browser and enter **new feature in v8**.

Printed and Online Tutorials

The tutorials are provided in two forms, as an online help file, and as a printed manual. Due to space limitations, not all of the tutorials are printed in the book.

Links between the online tutorials and the User Reference appear in the printed manual as underlined text. Illustrations are printed in black and white in the manual, and are full color in the online system.

To do the online tutorials, from the 3ds Max Help menu, choose Tutorials to display the online collection.

Acknowledgements

Special thanks are due to a number of hardworking and talented individuals who helped create this volume of tutorials. A tip of the virtual hat to:

- Jean-Yves Arboit, Jaykar Arudra, Alessandro Baldasseroni, Beans Magic Co. Ltd, Martin Coven, Frances Gainer Davey, Joana Garrido, Tommy Hjalmarsson, Kameswaran R. Iyer, Michael Koch, James Ku, Sören Larsson, Daniel Martínez Lara, Casey McGovern, Eni Oken, Ponsonnet Olivier, Ben Paine, Herman Saksono, Johannes Schlörb, Pradipta Seth, Metin Seven, and Marc Tan, for creating beautiful images using 3ds Max and allowing their reproduction in the online tutorial collection.
- Michael B. Comet, for creating the character bones and rigging tutorials and the low-poly character-modeling tutorial.
- Brandon Davis and Grant Adam, for the Particle Flow and particle effects tutorials.
- Alberto Flores, for design of the mental ray water material.
- Swami Lama, for providing the tutorials on scripting.
- Peter Carisi de Lappe, of the Autodesk Media & Entertainment Quality Engineering group, for his help creating the lesson on using IK and FK together.
- Pia Maffei, of Applied IDEAS, for providing the head model used in the *Creating the Skin Material* tutorial. The model was created with Applied IDEAS's Head Designer plug-in.
- Jon McFarland, for providing the tutorials on working with CAD files, and fixing problems in imported files.
- Paul Neale, for additional tutorials on character rigging.

- Jeff Patton, along with other users on the Web, for good tips on how to use the mental ray (lume) Ocean shader.
- Mirosław Piekutowski, for the model demonstrating the mental ray Dielectric Material shader.
- Retired Captain Irv Styer, fighter pilot, for expertise and assistance in modeling for the P-38 tutorial.
- Fred Ruff and Mike O'Rourke for the games and skin-deformers tutorials.

Where to Find Tutorial Files

Most of the tutorials in this volume require you to load sample files to start and complete the lessons. These files *do not* install automatically on your local drive when you install 3ds Max 8. All the files for these exercises can be found on the product disk. In order to do the tutorials, you must manually copy the sample files from that disk to your local hard drive using My Computer or Windows Explorer.

To install the tutorial files:

1. Locate your 3ds Max product disk.
2. Open My Computer or Windows Explorer, and navigate to the disk.
3. Copy the *tutorials* folder.
4. Navigate to your installation of 3ds Max 8 and paste the folder.

Now you have a `|3dsmax8|tutorials` folder on your local drive.

Tip: If you have limited hard drive space, you can copy individual directories from the disk.

How to Learn 3ds Max

Besides the tutorials found in this *3ds Max 8 Tutorials* collection, there a number of other resources to help you learn 3ds Max.

Autodesk Learning Resources

- **Autodesk Authorized Training Centers for Media and Entertainment:** Autodesk has authorized more than 100 training centers in over 30 countries worldwide. You can take intensive courses with flexible schedules to meet your needs. To find a center near you, visit: www.autodesk.com/me_training.
- **Autodesk Learning and Training Materials:** Check out Autodesk's latest learning and training materials: go to www.autodesk.com, click Store, and then click Learning and Training. Here, you can get training manuals designed for the instructor-led training environment, purchase books, and download individual E-courses to view off line. Training DVDs are also available for our most popular products.
- **Autodesk Online Support World-Wide:** The Autodesk Support web site www.autodesk.com/3dsmax-support provides access to a wide range of product information and support resources: searchable Knowledgebase, FAQs, technical bulletins, tested hardware information, and product downloads.
- **Discussion Forums:** Information and assistance are also available on the peer-to-peer online discussion forum. To visit the discussion forums, go to www.autodesk.com/3dsmax-discussion, or from the 3ds Max Help menu, choose 3ds Max on the Web > Online Support.
- **3ds Max 8 User Reference:** The online reference covers fundamental concepts and

strategies for using the product, as well as details about the features of 3ds Max. Access the User Reference online by choosing Help > User Reference.

- **Additional Resources:** A number of additional Help files are installed with the software. For details, see the topic "3ds Max Documentation Set" in the *User Reference*.
- **Other Resources:** There is a wealth of information written about using 3ds Max. There are third-party books that specialize in teaching the software for various industries. There are magazines devoted to 3D design and animation, as well as user groups and mail lists. Communities of users trade secrets daily, and if you ask a question, you're likely to get answers from experts all around the world.

Working with the Tutorials Online

You can run the online tutorials by going to the Help menu on the 3ds Max menu bar and choose Tutorials. This runs *3dsmax_t.chm*, a file found in the *13dsmax8\help* folder. The tutorials appear in a window which floats on top of the 3ds Max user interface. You can position this window like a Schematic View or Track View horizontally across a row of viewports. Or you may prefer to resize the window so it is a column covering two viewports on the left or right.

This window has the behavior that it will always stay on top of the other displayed program windows. If it is blocking your view of a viewport, you can pick it up and move it all the way left or right, leaving only a small slice or corner of the window in view.

You can also run this file directly from My Computer or Windows Explorer, and then use **ALT+TAB** to switch between the view of the tutorial and the program.

If you have a dual monitor system, you can see both the tutorials and the user interface in a large window at the same time by moving the tutorials window to the second display.

If you are running on a small monitor, it can be a challenge to find the real estate needed to see the tutorial and the viewports. One trick you can use is to change the viewport configuration to adapt for this.

Suggested Viewport Layouts

You can also change your viewport layout to accommodate the online tutorial window. Do the following:

Configure your viewport layout:

1. Start 3ds Max 8.



Press the Min/Max toggle if you don't see 4 viewports.

2. Activate the Perspective viewport, if it isn't already active.
3. Right-click the Perspective viewport label, and choose Configure.

The Viewport Configuration dialog appears. Click the Layout tab.

4. Choose the viewport configuration that has three viewports on the right and one on the left.

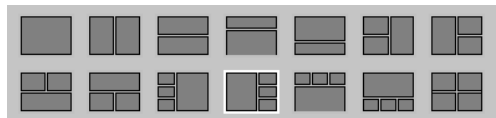

5. Open the Tutorials window and resize it so it covers half the large viewport.

You now have effectively five windows.

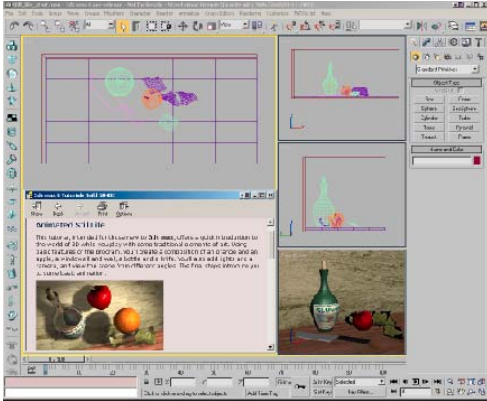

- If you prefer, you can also choose a viewport configuration with three viewports above and one viewport below.

Displaying the Tutorials in a Viewport

Another alternative is to display the Help directly in a viewport. This is not a regular feature of 3ds Max, but since this is a customizable program, there is a script that can do this.

Note: We have provided this script as a convenience; it is not a supported feature.

To display the tutorials in a viewport:

- Using Windows Explorer or My Computer copy *helpinvp.ms* from the `|tutorials\tutorial scripts|` folder on the CD to `|3dsmax8|scripts|maxscripttools` folder.
- Start 3ds Max.
- On the menu bar choose MAXScript > Run Script
- Navigate to the `|3dsmax8|scripts|maxscripttools` folder. Highlight *helpinvp.ms*, then click Open to run the script.

Running this script adds the Help in a Viewport functionality to the session.

- On the menu bar choose Customize > Customize User Interface.

The Customize User Interface dialog appears.

- On the Keyboard Shortcuts tab click the drop-down arrow next to Category. Scroll to the bottom and find Web Tools. Click it, and choose Help in Viewport.
- Click in the Hot Key field then assign a hotkey. Any keystroke combination you press will appear. We suggest **ALT+H**.
- Once the hotkey has been assigned, close the dialog using the X button at the upper right corner of the dialog.
- Activate the left viewport, and press **ALT+H**. A Floating tutorial window appears.
- Right-click the Left viewport label and choose Views > Extended > Help in Viewport.

The Welcome tutorials display in the viewport. Scroll down to the tutorials you wish to see and click the link. That tutorial will display in the viewport.

Note: The Navigation pane is not available when you display tutorials in the viewport. Use the Welcome topic links to navigate to the tutorial you wish to do. Right-click and choose Back to return to previous topics.

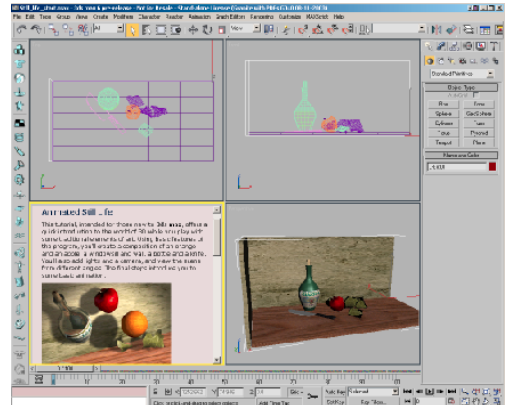

Printing the Tutorials

The 8 tutorials are provided in a printed volume that accompanies the software program. Not every tutorial in the online set is included in this book, however.

If your computer is connected to a printer, you can print single Help topics or entire chapters.

To print a topic or chapter:

1. Open the online tutorials.
2. To print a topic or chapter, highlight the topic or chapter title and click the Print button at the top of the Help display.

A dialog appears.

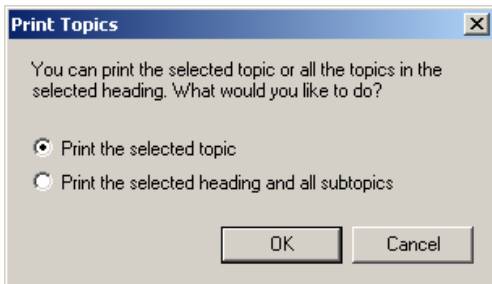

3. Choose to print only the selected topic, or to print all topics in that chapter. After you make your selection, another dialog appears where you can choose your printer and other options.

The tabs available at the top of the dialog depend on the selected printer.

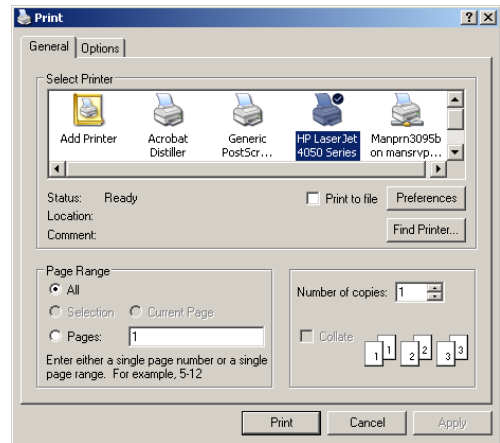

4. Choose options for the print job, and click Print to begin printing.

User Showcase

In the 3ds Max 8 tutorials we teach you the tools to use the software. Put those tools in the hands of talented artists and magic happens.

Here is a gallery of images by creative individuals from around the world using this software. We hope you find these images inspiring before you set out on your journey of learning 3ds Max 8.



Chinese Opera

James Ku

www.3dartisan.net/~kuman/



The Ancient Indian Crown

Kameswaran Ramachandran Iyer, India

www.kameswaran.com



Unpleasant Company

Metin Seven



A Living Room

Frances Gainer Davey



Guardian of the Enchanted Forest
 Marc Tan, Insane Polygons



Old Courtyard
 Pradipta Seth



by Tommy Hjalmarsson
<http://hem.bredband.net/tomhja>



by Tommy Hjalmarsson
<http://hem.bredband.net/tomhja>



Student Breakfast
 Jean-Yves Arboit, Belgium
www.discreetcenter.com



Electric Water
Johannes Schlörb



by reiv: Ponsonet Olivier
<http://reiv.fr.st/>

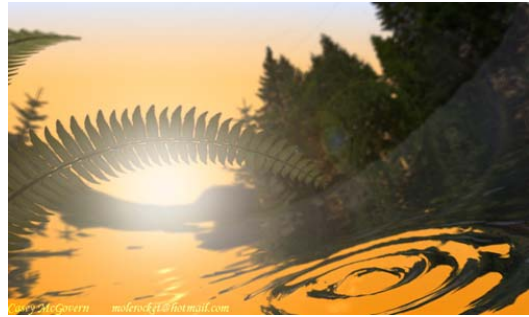

Ripples of Spring
Casey McGovern
molerocket@hotmail.com



Indian Beauty
Jaykar Arudra, AMM Studio, India



by Ben Paine



Old Sunflowers

Joana Garrido (Caixa D'Imagens), Portugal



Pistol Pete

Martin Coven



Sommar Torp: "Summer House"

Sören Larsson, Sweden

www.3dbetong.se



Anibal

Daniel Martínez Lara (Pepeland)

All images are copyright. Reproduction and distribution is not permitted without the owner's permission.

2

Welcome to 3ds Max 8

New to 3D

If you are new to the whole idea of creating 3D models and animation on the computer, start by reading the *Getting Started with 3ds Max* chapter of the [3ds Max 8 User Reference](#). This chapter contains fairly brief conceptual sections that introduce the ideas and terminology you need to understand how to use 3ds Max. You can read this chapter online, by choosing User Reference from the Help menu.

Once you have familiarized yourself with the concepts of 3D modeling and animation, move on to the Getting Started lessons. These will introduce your hands and mind to the basic concepts of working in 3D and to using the program in its various aspects.

Here are links to some of the Getting Started tutorials:

Modeling Tutorials:

- *Modeling a Chess Set (page 1-21)*

In this tutorial, you will create four pieces of a chess set using various modeling tools and techniques.



Material & Mapping Tutorials:

- *Ink 'n Paint Material (page 1-215)*

The Ink 'n Paint material lets you create comics-style images without ever touching a pen or brush. This short lesson will show you a few of the options that are available with this versatile material.



Animation Tutorials:

- ***Bouncing a Ball (page 1–223)***

A bouncing ball is a common first project for new animators. This classic example is an excellent tool for explaining basic animation processes in 3ds Max.

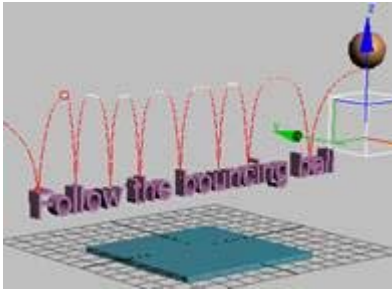

Special Effects Tutorials:

- ***Modeling Whipped Cream (page 1–473)***

BlobMesh is a compound object in 3ds Max that creates a set of spheres from geometry, shapes, or particles, and connects the resulting mesh together as if the spheres were made of a soft substance.



Character Animation Tutorials:

- ***Biped Quickstart (page 1–281)***

This tutorial introduces you to the elements of the built-in character animation features in 3ds Max and the workflow for some of its most important features.



Rendering Tutorials:

- ***Lighting a Close-up of a Head (page 1–415)***

To light a subject, such as a talking head or a still life, it helps to think in terms of how you would light the same subject if you were working on a stage set or in a photo studio. There are some widely used guidelines to lighting this way, and this section introduces them.

Things to try:

There are many more tutorials in the ***Getting Started (page 1–46)*** section. When you are done with the ones listed above, try your hand at some of the others.

You can also experiment with the tutorials found in the ***Basic Projects (page 3–1)*** section. These tutorials cover different aspects of 3ds Max such as Modeling, Rendering, and Animation in single, project-oriented tutorials.

What's New in 3ds Max 8



To learn about the new features, first read the *3ds Max 8 New Features Guide*, the printed booklet that comes with 3ds Max. If you want to read this online, you can open the PDF file by going to the Help menu, and choosing New Features Guide.

Or you can read the topic [What's New in 3ds Max 8](#) in the *User Reference*.

There are many additions to 3ds Max 8, some of which are outlined in the following tutorials:

Modeling Tutorials:

- ***Modeling a Low-Poly Character (page 2–199)***
Use new polygon modeling tools including Poly Bridge and grow/shrink selections along rings and loops.
- ***Using the Sweep Modifier (page 3–62)***
Create simple lofts with this quick and easy-to-use modifier.

Materials & Mapping Tutorials:

- ***Mapping a Character (page 2–236)***
New Unwrap UVW workflow and Pelt Mapping, which allows you to stretch out UVW coordinates to create a flat unified map for texturing objects.
- ***Creating Real-World Materials and Mapping (page 3–65)***
Specify real-world sizes for bitmaps.

Rendering Tutorials:

- ***Using Radiosity Adaptive Subdivision (page 3–68)***

Use adaptive sub-division to add detail where you need it in the Radiosity simulation.

- ***Saving Scene States (page 3–70)***
Save camera and lighting setups, material definitions, environment controls and other values for quick and easy recall.
- ***Using Batch Render (page 3–72)***
Automate the rendering of scenes using this tool that works in perfect sync with Scene States.

Animation Tutorials:

- ***Working with Animation Tracks (page 1–270)***
Create Tracks Sets for easier animation track management and experiment with new Curve Editor improvements.
- ***Using the Limit Controller (page 2–187)***
Use this controller to limit the range of other types of controllers.

Character Animation Tutorials:

- ***Using the Skin and Flex Modifiers (page 2–426)***
Use new Skin defaults and Better Skin Controls using the new Weight Tool.
- ***Using Biped Euler Rotations and Function Curves (page 2–502)***
Control Biped Limbs Using Function Curves in the Curve Editor.
- ***Biped Retargeting (page 2–493)***
Retarget one biped to another and fine-tune the motion using Layers.
- ***Using Twist Links (page 2–499)***
Use Twist Links to add twisty bones to the biped figure.
- ***Character Rigging Tools (page 2–456)***

Save Animation files to the new XML-based animation format and reload them onto the same rig or onto another one. Remap bones from one skeleton to the next to retarget one character to another.

AEC Tutorials:

- ***Publishing to DWF (page 2-78)***
Post your 3D Scenes on the Internet with the new 3D DWF support.
- ***Inventor Interoperability (page 2-125)***
Experiment with the connectivity between Inventor and 3ds Max.
- ***Revit Interoperability (page 2-132)***
Use the File Link Manager to link 3ds Max to your Revit Designs.

Dynamics Tutorials:

- ***Using Hair (page 2-743)***
Simulate hair and fur in a variety of ways.
- ***Using Cloth (page 2-766)***
Simulate the motion of fabric and other soft bodies using this tool.

Project Management Tutorials:

- ***Using Asset Tracking (page 2-937)***
Use this tool to get direct access to Asset Tracking Systems (ATS) such as Autodesk Vault.

Game Design

If you are new to the world of 3D, start with the ***New to 3D (page 1-11)*** page to get a good grasp of how to operate the software. If you are a current user but want to learn about special techniques pertaining to game design, you can learn about them in the Specialized section of the tutorials.

Listed below are links to some games-related tutorials:

Modeling Tutorials:

- ***Modeling Tutorials (page 2-199)***
This tutorial explains how to model a character by making extensive use of the Editable Poly object and Edit Poly modifier.



Materials & Mapping Tutorials:

- ***Mapping a Character (page 2-236)***
This tutorial explains how to map a character working with the Unwrap UVW Modifier. This modifier provides tools that go beyond traditional mapping techniques.



Rendering Tutorials:

- ***Painting Vertex Colors (page 2-283)***
In this exercise, you take the lighting information from a file and add it to the vertex color information.



Character Animation Tutorials:

- ***Basic Rigging (page 2–299)***

A *Character Rig* is a setup designed to facilitate control of a character. You can think of a character rig as the 3D equivalent of strings that control a marionette. If the strings are well placed and properly set up, the puppet is very easy to control. The same is true for a character rig.



Biped Tutorials:

- ***Biped Retargeting (page 2–493)***

This tutorial explains how you can retarget one character onto another and ensure that some of the limbs accurately match the position and rotation in space of the original character.

Dynamics Tutorials:

- ***Using Hair (page 2–743)***

The tutorials included in this section walk you through a variety of methods for using Hair.



Special Effects Tutorials:

- ***Creating Guided Missiles (page 2–904)***

In this tutorial, a biplane tries to shoot down some rebel teapots. This biplane has been modified with missile pods on each wing that will emit particles. Each missile pod will emit one particle. Each particle will use instanced geometry of a missile and seek a teapot at random, trailing smoke particles along the way. When a missile particle reaches its target, it will trigger an explosion event.



Things to try:

Other tutorials are suitable for game design. When you are done with the ones listed above, try your hand at some of the other tutorials listed in the Contents under Getting Started, Specialized, and Projects.

Sometimes Game Design and Film overlap in workflow and/or their pipelines. If you wish, try your hand at the tutorials found in the *Film & TV Effects* (page 1–17) page.

Design & Visualization

If you are new to the world of 3D, start with the *New to 3D* (page 1–11) page to get a good grasp of how to operate the software. If you have some working knowledge of 3ds Max and are already familiar with other 3D products such as AutoCAD, Inventor or Revit, then you can follow the lessons in the *AEC* (page 2–1) section of the tutorials.

Listed below are links to some of the Design & Visualization tutorials:

AutoCAD-related Tutorials:

- *Working with AutoCAD Files* (page 2–82)

The integration of drawings created with AutoCAD and 3ds Max scenes has never been tighter than it is with 3ds Max 8. DWG files convert cleanly and maintain their layer identities, and you have control over import smoothing, normal unification, and several

other geometry specifications. You have the capability to import entire drawings, merge specific layers or components, and even create a live link between 3ds Max and AutoCAD.



Revit-related Tutorials:

- *Revit Interoperability* (page 2–132)

In this tutorial, you learn how to use 3ds Max in conjunction with Autodesk Revit 7. Autodesk Revit is a building system that lets you conceptualize your architectural designs quickly and efficiently. Once you have created your design in Revit, you can export it and link it to 3ds Max to create high quality renderings and animation.



Publish to Web Tutorials:

- *3D DWF Support* (page 2–78)

In this tutorial, you learn how to publish (export) to a 3D DWF format. The DWF format allows people to view your designs without having 3ds Max installed on their system. With the free DWF viewer available for download, you can email your 3D concepts or

simply post them on the Internet to painlessly reach a wider audience.

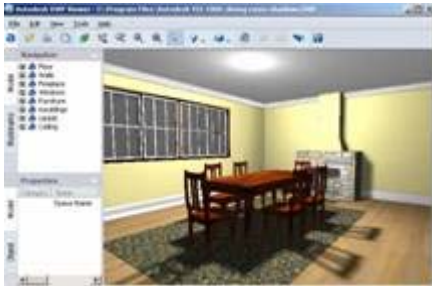

they can help you store various conditions that can be recalled at a later time for visualization and rendering purposes. Radiosity adaptive subdivision will be used for preliminary rendering so you can create more accurate and realistic images. Finally, you'll get to experience the batch rendering tool and how it can help you increase efficiency when you're ready to generate renderings for clients.



Global Illumination Tutorials:

- *Changing how objects behave under Global Illumination (page 1–446)*

The global illumination options, radiosity and light tracing, use object colors when they calculate the color and energy of bounced light. In this example, you set up some objects to emit light that affects radiosity. The way to adjust a material's behavior under global illumination is to give it an Advanced Lighting Override material.



Scene Management Tutorials:

- *Scene Management (page 3–61)*

This tutorial touches on a number of the new features you will find in 3ds Max. The scene you work on shows a covered porch or balcony that needs some detailing by means of the Sweep modifier and real-world materials. You'll become familiar with scene states and how

Things to try:

Other tutorials are suitable for *Design and Visualization (page 2–1)*. When you are done with the ones listed above, try your hand at some of the others.

Film & TV Effects

If you are new to 3ds Max, start with the *Getting Started (page 1–46)* tutorials to get a good grasp of how to operate the software. If you already have some working knowledge of 3ds Max, you can follow the lessons in the Specialized and Advanced Projects sections of the tutorials.

Here are the links to some of the Film & TV Effects tutorials:

Materials & Mapping Tutorials:

- *Introducing Normal Bump Mapping (page 2–251)*

Normal Bump Mapping refers to a new technique for simulating high-resolution surface detail on low-resolution polygonal models. Normal Bump Mapping is similar in some respects to regular bump mapping, but it conveys more complex surface detail than is possible in regular bump mapping. Normal bump maps store information on the direction normal of the surface in addition to the simple depth information used in regular bump mapping.



Character Animation Tutorials:

- ***Character Rigging Tools (page 2–456)***

With the new rigging tools in 3ds Max 8, you can load and save animation clips, share them between characters, and have full control as to how motion is transferred. You can use the new retargeting tools to go from any kind of rig to another, and you can use the Motion Mixer, once compatible with biped objects only, to layout and create transitions between motion clips effortlessly.



- ***Lip-Sync Animation (page 2–475)***

In this tutorial, you will learn two methods for producing lip sync animation. In the first lesson, you will use modifiers to animate the mouth for speech. In the second lesson, you will create a morph target of your own and animate it with the Morpher modifier.



Animation Tutorials:

- ***Animating Crowds (page 2–638)***

This tutorial covers a range of techniques used with the 3ds Max crowd-animation features for creating and animating crowds. Crowd animation starts out with behaviors applied to delegates, which serve as stand-ins for crowd members. Next, that motion is applied to mesh objects or bipeds. These objects might carry their own animation, which can be combined with the delegate animation in a variety of ways. In the final part of this tutorial, you'll learn how to use motion synthesis to apply different parts of a mesh object's animation to each crowd member, based on its current behavior.



Dynamics Tutorials:

- *Using Hair (page 2-743)*

The tutorials included in this section walk you through a variety of methods for using Hair.



- *Using Cloth (page 2-766)*

The tutorials included in this section walk you through a variety of methods for using Cloth.



Rendering Tutorials:

- *Mental Ray (page 2-805)*

The mental ray renderer is an alternative to the 3ds Max default scanline renderer. Created by mental images®, it is a general-purpose renderer that can generate physically correct simulations of lighting effects, including ray-traced reflections and refractions, caustics, and global illumination.



Special Effects Tutorials:

- *Crashing an Asteroid into a Planet Surface (page 2-885)*

In this tutorial, you'll start with a relatively large asteroid crashing into a planet surface. The collision creates massive after effects, including a shock wave with more rocks jumping up from the leading edge, all trailing fiery particles.

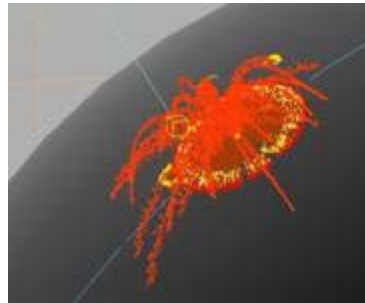

Camera Tutorials:

- *Using Camera Match (page 3-114)*

Using the Camera Map modifier and other techniques, you will mix video and computer generated graphics using the Camera Match utility. You will then add some special effects to the camera-matched scene. You will animate a cue ball and synchronize it with the movement of actors in the pool hall video. Finally, you'll create a matte object so the cue ball can move behind the bitmap of the player's hand, and

you'll use the Camera Map modifier to create a wave in the table.



Things to try:

Sometimes Film and Game Design overlap in workflow and/or their pipelines. When you are done with the tutorials listed above, try your hand at the ones found on the *Game Design (page 1-14)* page.

3

Getting Started

Modeling

Modeling a Chess Set

In this tutorial, you will create four pieces of a chess set using various modeling tools and techniques.



Skill Level: Beginner

Time to complete: 1 hour

Features Covered in This Tutorial

You will make a pawn, a bishop, a rook and a knight in these lessons. In the course of making these objects you will learn:

- Creating and editing spline objects.
- Using Lathe modifier to create a 3D object.
- Using Face extrusion to create geometry.
- Using Boolean compound objects.
- Using viewport background images.
- Using the Surface modifier.

Tutorial Files

All the necessary files for this tutorial are provided with the software and can be found in the *|tutorials|intro_to_modeling* directory. Before starting the tutorials, copy the *|tutorials* folder to your local *|3dsmax8* installation.

Modeling a Pawn

In this lesson, you will model a pawn for a set of chessmen. In a wooden chess set of standard design, pawns are turned on a lathe. You will use 3ds Max to do something similar: draw the pawn's outline, and then use a Lathe modifier to fill out its geometry. The Lathe modifier revolves the outline

around a central point to create a shape, not unlike the way wood is turned on a machine lathe.



Features and techniques covered in this lesson:

- Using spline shapes to draw the outline of an object.

This lesson also briefly introduces you to spline editing.

A spline is a type of curve that is interpolated between two endpoints and two or more tangent vectors. The term dates from 1756, and derives from a thin wood or metal strip used for drafting curves in architecture and ship design.

- Editing the shape vertices and edges to better control spline drawing.
- Using the Lathe modifier to turn a 2D outline into a 3D model.

Tutorial Files:

Tutorial files for this lesson can be found in the *tutorials\intro_to_modeling* folder.

Skill Level: Beginner

Time to complete: 15 minutes

Set up the lesson:

- Start 3ds Max or choose File > Reset if the program is already running.
- No startup file is necessary for this tutorial.

Set up the viewport background:

To create the profile of the pawn (and other chess pieces), you need to load a reference image into the viewport so you can trace over it.

1. Right-click the Front viewport to make it current.
2. From the Views menu, select Viewport Background. The Viewport Background dialog appears.

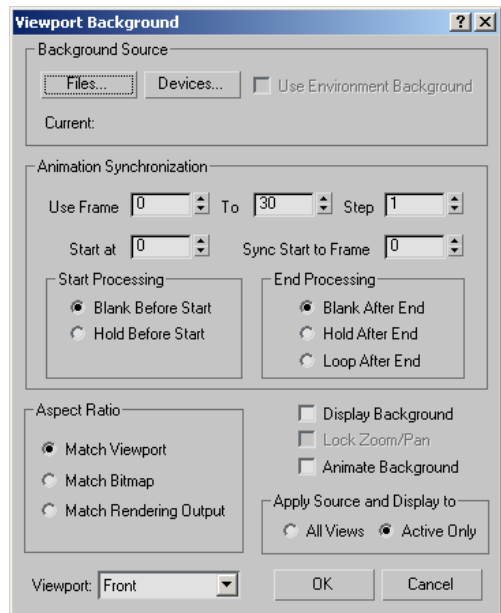

3. Click the Files button. Open the *tutorials\intro_to_modeling* folder, and then double-click *ref-chess.jpg* to load it.
4. In the Aspect Ratio group, choose Match Bitmap. This ensures the image in the viewport does not get distorted.

- To the right of the dialog, turn on Lock Zoom/Pan. This ensures the background image reacts to zooms and pans you may use for viewport navigation.

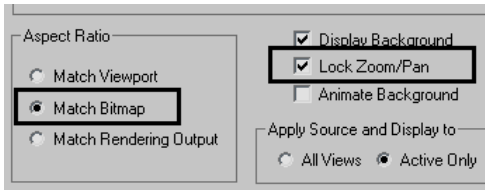

- Click OK to exit the dialog. A bitmap now appears in the Front view. Press the G key to disable the grid, as you won't need it for this exercise.

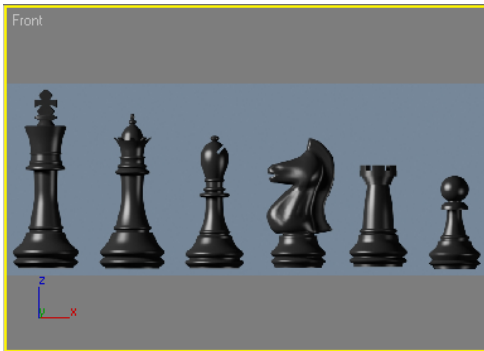

Now you are ready to begin drawing.

Start the pawn's outline:

You will draw the pawn's outline beginning with the "knob" on top.

- Zoom in on the pawn reference in the Front view.
- On the Create panel, click Shapes, and then click Line.
- On the Creation Method rollout, set both Initial Type and Drag Type to Corner. This ensures all line segments will be linear.

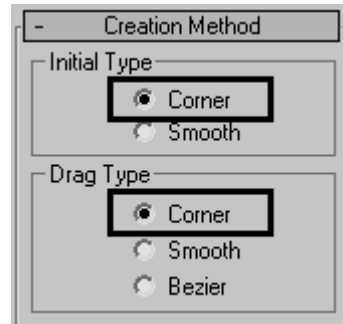

- In the Front viewport, click a point near the top center. Hold the SHIFT key to constrain the line to the vertical axis and then click a second point at the base of the pawn.

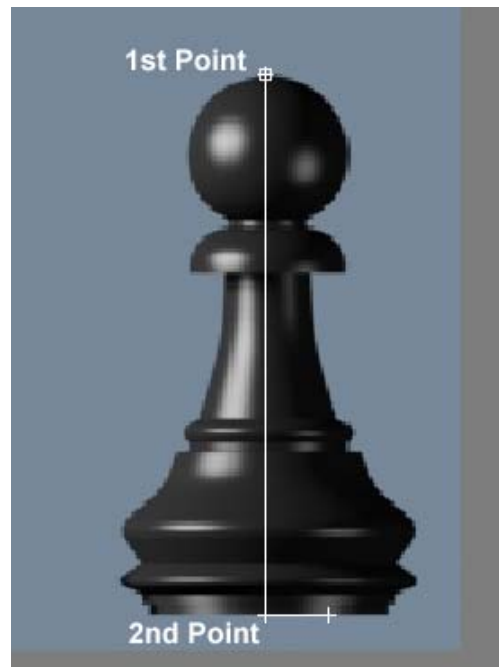

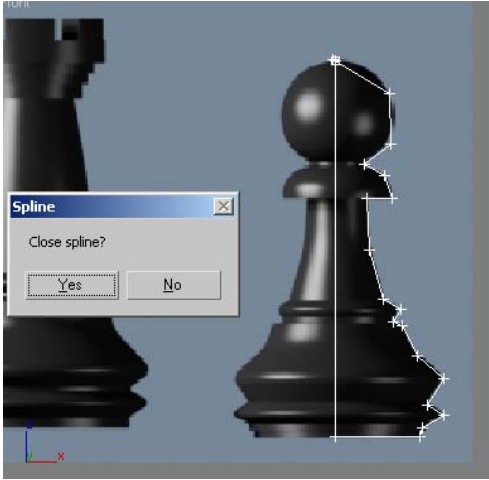

- With the Shift key still pressed, click a point in the bottom-right edge of the base.
- From this position, click a few points on the right contour of the reference image to create a rough profile, going up the side of the image. You do not need to be very precise at this time

as you will be able to edit the profile later. To close the spline and end the command, click on the first point.



7. When prompted, click Yes to close the spline.

Edit the pawn's outline:

1.  With the spline still selected, go to the Modify panel.
2.  On the Selection rollout, click the Vertex button.
3. In the Front viewport, zoom in on the bottom part of the profile you created.
4.  Use the Select And Move tool to adjust the vertices as shown in the following illustration.

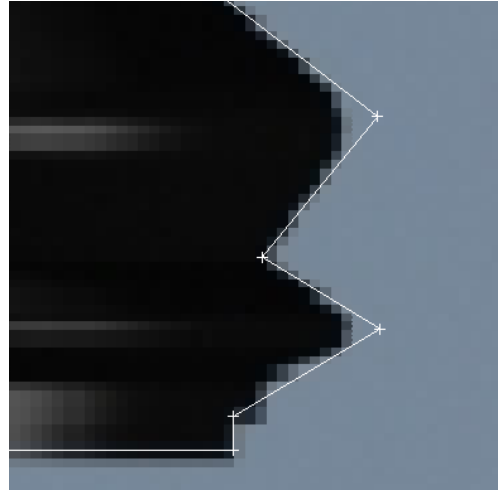

5. Select the two rightmost vertices and then activate the Fillet button on the Modify panel.
6. With the Fillet command active, place the cursor on one of the selected vertices and then click and drag to round off the two corners, as shown below.



7. Pan up to work on the middle section of the profile.

8. Select the vertex above the rounded corner you just created. If necessary, move it to a better position, based on the reference image.

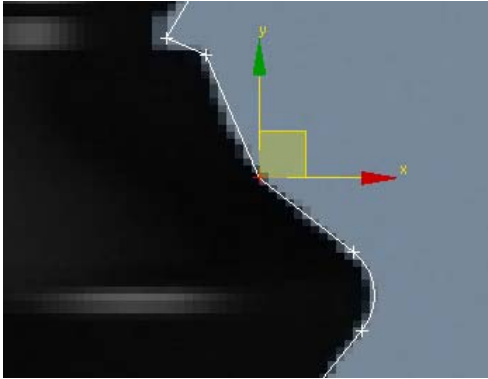

9. With the vertex selected, right-click in the viewport and from the quad menu that appears, choose Smooth.

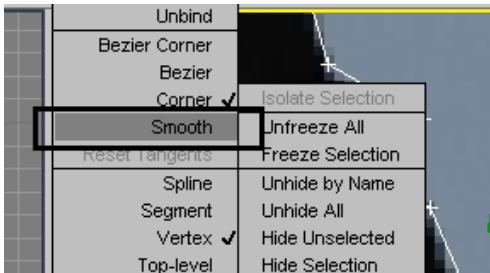

10. Adjust the vertex position to match the reference image.



11. Pan up to the next set of vertices.



In some situations, you might need to add a vertex.

12. On the Modify panel > Geometry rollout, choose Refine.

13. Click the line where you need to insert the vertex.

A new vertex is added to the spline.

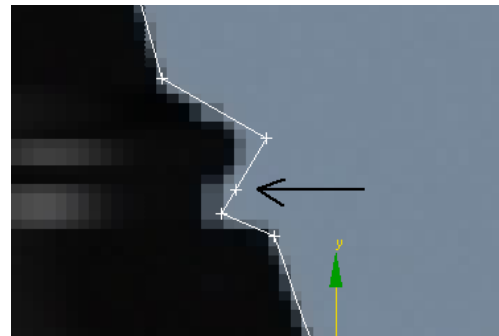

14. Using the Move tool, adjust the position of vertices as shown in the following illustration.

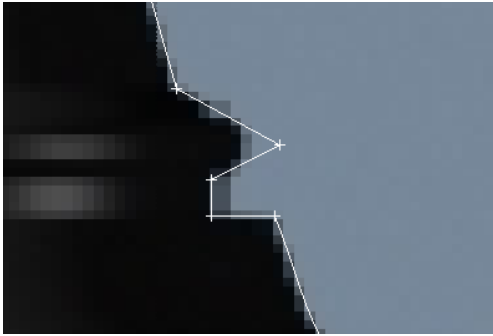

15. Select the vertex sticking out to the right and fillet it to create a curve, as you did earlier.



16. Pan up the profile. Select the two vertices shown in the following illustration.

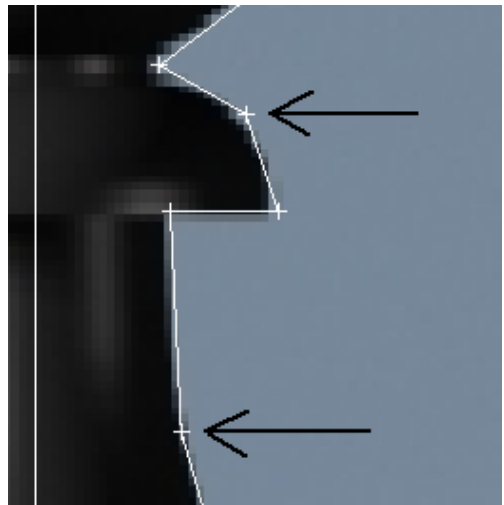

17. Using the quad menu, convert the two selected vertices to Smooth vertices, as you did earlier. Move them to fine-tune their positions.

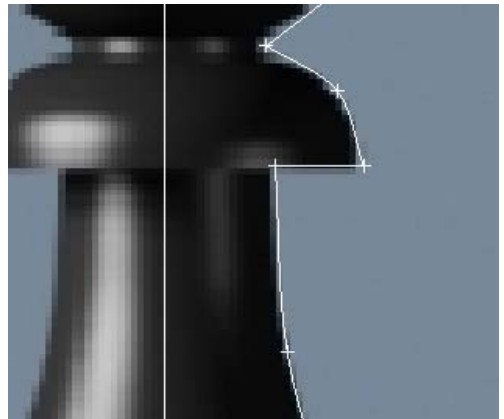

18. Pan up to the top part of the profile. Select the two vertices to the right of the knob and make them Smooth vertices. Again, use the Select And Move tool to fine-tune their positions.

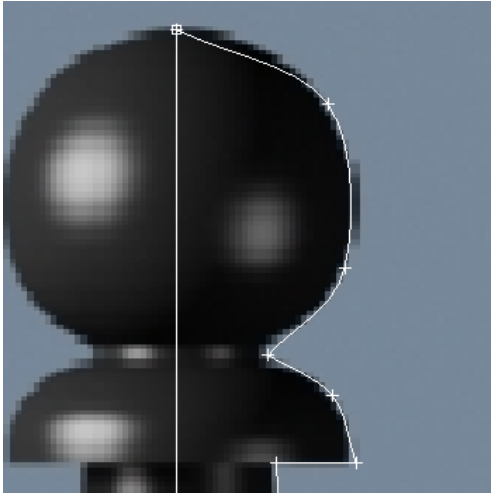

19. Zoom in to the base of the knob.

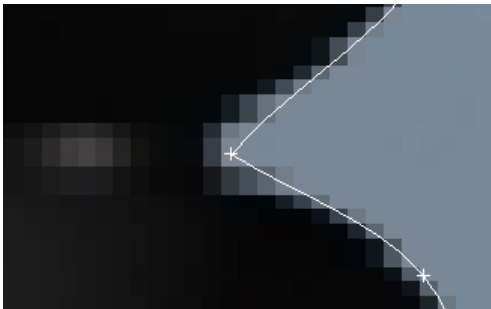

20. If you have only one vertex at the base of the knob, use the Refine tool as you did earlier to add another vertex.

21. Select both vertices and right-click to access the quad menu.

22. Use the quad menu to convert both vertices to Bezier Corner.

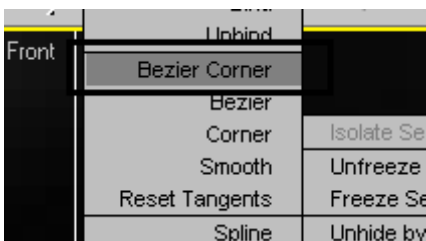

23. Use Select And Move to adjust the positions of the vertices and their handles to get the proper curvatures around the base of the knob.

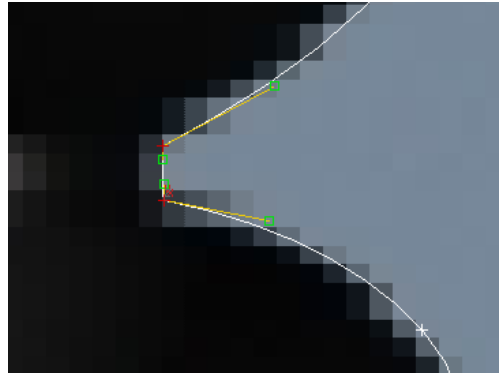

24. Select the first vertex you created, at the very top of the profile. Use the quad menu to convert it to Bezier Corner.

25. Adjust the handles to match the curvature on the reference image.

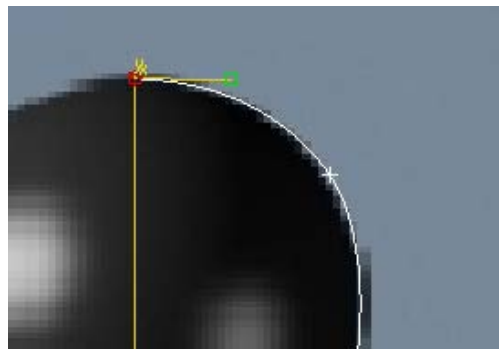

26. Continue refining your profile, adjusting vertex positions and types to match the reference image.

27.  When you are done, click the vertex button in the Selection rollout of the Modify panel to exit the sub-object level.

Lathe the outline:

At this point, you can continue with the file you created in the previous steps, or you can open the file *pawn_outline_edited.max*, and continue from there.

1. Select the pawn and click Modifier List above the modifier stack display.

This is a drop-down list of various modifiers.

2. From the list, choose Lathe.

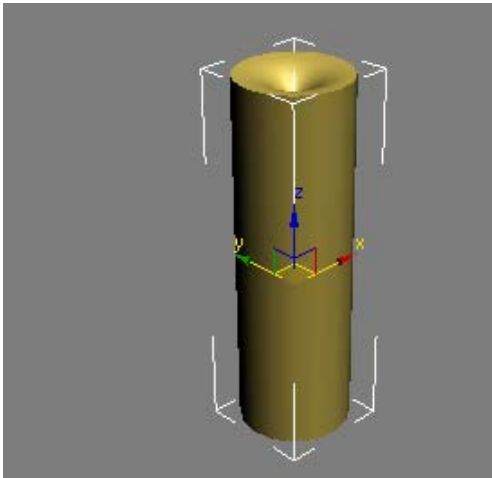

The pawn is now a 3D object.

The pawn model might not look as you expected, but that's only because the axis of revolution, by default, is based on the spline's pivot point rather than the left side of the profile. You will fix that in the next step.

3. On the Parameters rollout of the Lathe modifier, find the Align group and click Min.

The pawn now looks better, albeit a bit "choppy."

4. On the Parameters rollout of the Lathe modifier, increase the Segments value to **32**.

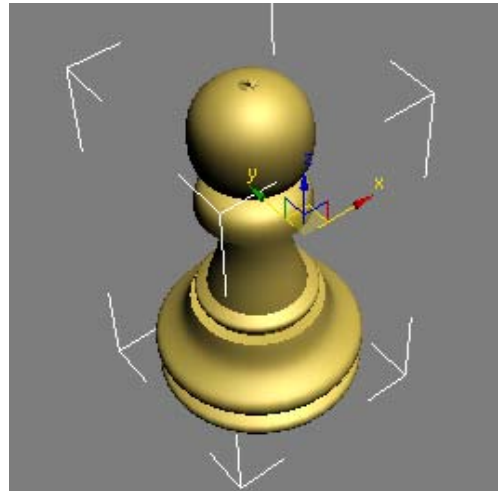

The pawn is now smoother, as you can see if you render the Perspective viewport, but the center seems a bit pinched.

5. On the Parameters rollout of the Lathe modifier, turn on Weld Core. This combines all the vertices at the center of the model into one.

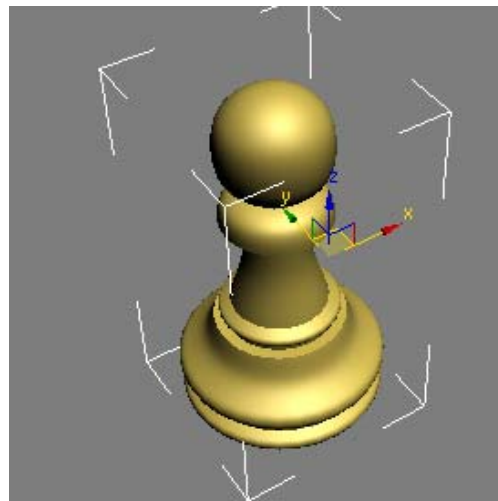

In the Introduction to Materials and Mapping tutorials, you'll provide the chess pieces with more-convincing color and texture and create a shiny, reflective wood-grain chessboard.

Summary

In this lesson you learned spline creation and editing. You also learned to create 3D geometry using the Lathe modifier.

Modeling a Bishop

In this lesson you will model a bishop for the chess set. For the most part, the bishop is modeled the same way as the pawn, based on a profile shape and a lathe modifier. The difference is the gap that shows on the bishop's head. You will use a Boolean object to achieve that result.



Features and techniques covered in this lesson:

- Using spline shapes to draw an outline of an object.
- Using the Lathe modifier to turn a 2D outline into a 3D model.
- Using Boolean to subtract geometry.

Skill Level: Beginner

Time to complete: 15 minutes



Set up the lesson:

- The basic shape for the bishop is built exactly the same way as the pawn in the last lesson. Follow the procedures in the “Modeling a Pawn” exercise or open the *bishop_outline_edited.max* file to work with a finished shape.

This file contains the profile of the bishop and a reference background image. If you cannot see the reference image, do the following steps.

1. Make sure the Front viewport is selected and then press **ALT+B** to open the Viewport Background dialog.
2. On the dialog, click the Files button.
3. Locate the *ref-chess.jpg* image in the *intro_to_modeling* folder and double-click it.

Lathing the Bishop

1.  On the main toolbar, click the Select tool. Select the spline representing the bishop's profile in any viewport.
2.  With the Spline selected, go to the Modify panel. From the Modifier list, choose Lathe.
3. On the Parameters rollout, click the Min button in the Align group.
4. Set Segments to **32** and turn on the Weld Core option.

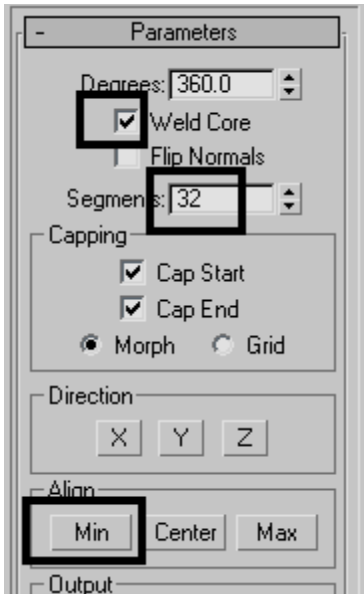



Create and position the box:

To create the gap in the bishop's head, you'll create a simple box and then subtract from the bishop model.

1. Zoom the Front viewport in, near the bishop's head.
2. From the Create menu, choose Standard Primitives > Box.
3. In the Front viewport, click and drag to define the base of the box. Do not worry about specific dimensions; you will change those in a moment.
4. Once you have defined the base, move the mouse and then click to define the height.
5.  Go to the Modify panel and set the dimensions of the box as follows:

- Length=15.0
- Width=2.0
- Height=50.0

6.  On the main toolbar, click the Select And Rotate button. Rotate the box in the Front viewport so that it is aligned with the gap on the bishop's head (in the reference image).
7.  Use Select And Move to position the box on top of the gap.
8. In the Top view, move the box on the Y axis (green axis) until you can see it on both sides of the bishop.

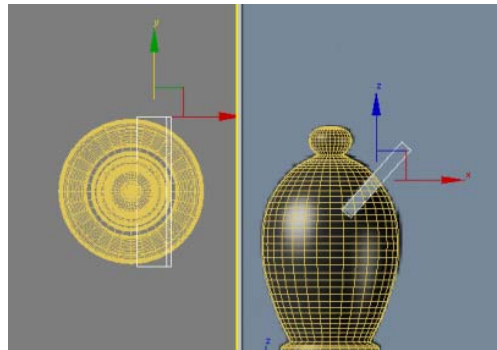

Create the slice with a Boolean operation:

1. Select the bishop in any viewport.
2. On the Create menu, choose Compound > Boolean. The bishop is now a Boolean object and the command panel automatically switches to the Create panel, showing you the parameters of the newly converted object.
3. On the Pick Boolean rollout, click Pick Operand B and then click the box in any viewport.

When you perform a Boolean operation, the first object selected (in this case the bishop) is recognized as Operand A and the second object selected (in this case the box) as Operand B. You can then choose the type of operation to perform, whether it's union, intersection, or subtraction, and, in the latter case, which operand to subtract from which.

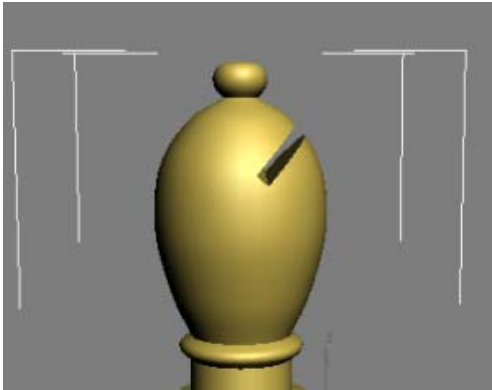

Summary

In this lesson, you learned to remove geometry by cutting a hole in an object using Boolean operations.

Modeling a Rook

In this lesson, you will model a rook for the chess set. You'll build the rook the same way as in the previous lessons, where you created a pawn and a bishop, except for the top part with the battlement. If you were making a wooden chess set, you wouldn't be able to use a lathe for this part of the piece, and so it is with the 3D model: Although the basic structure of the rook is a lathed spline, like the pawn and the bishop, its top requires a different modeling technique.



Features and techniques covered in this lesson:

- Using face extrusion to change geometry.
- Adjusting smoothing groups for better results.

Time to complete: 15 minutes

Set up the lesson:

- Open the *rook_outline_edited.max* file.



This file contains the basic shape of the rook. If you prefer to build the rook from scratch, delete the yellow profile and recreate it as you did in the previous lessons with the pawn and the bishop. Make sure, however, that you do not take into account the battlement at the top of the rook, as you will create those later using polygon extrusions.

The Front viewport should contain a reference image. If you cannot see the image, perform the following steps:

1. Make sure the Front viewport is active and then press **ALT+B** to open the Viewport Background dialog.
2. On the dialog, click the Files button.

3. Locate the *ref-chess.jpg* image in the *intro_to_modeling* folder and double-click it.

Lathe the basic shape:

1.  On the main toolbar, choose the Select tool. Select the spline representing the rook's profile in any viewport.
2.  With the spline selected, go to the Modify panel. From the Modifier list, choose Lathe.
3. On the Parameters rollout, click the Min button in the Align group.
4. Set Segments to **36** and turn on Weld Core.

Prepare the top for the battlement:

1. With the rook still selected, make sure you are still in the Modify panel. From the Modifier list, choose Edit Poly.
2.  On the Selection rollout, click the Polygon button.
3. Try selecting the top of the rook.
You can only select a fraction of the area; 1/36th of the top area, to be exact.

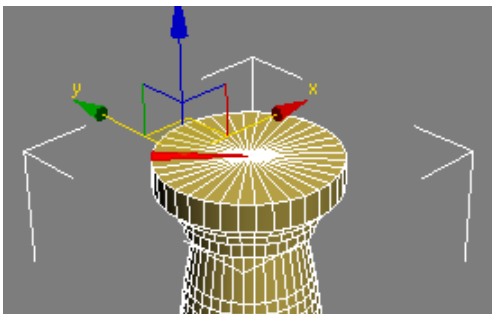

4.  On the Selection rollout, click the Vertex button.
5. Select the vertex in the top center area of the rook.

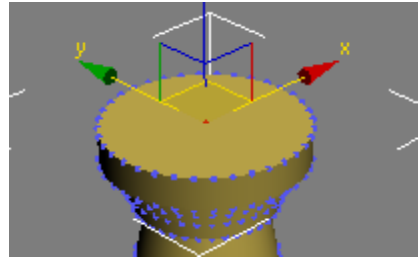

6. Hold the CTRL key down and click the Polygon button again on the Selection rollout. All polygons connected to the selected vertex are automatically selected.
7. Press F4 to turn on Edged Faces display, if necessary. This allows you to see the shaded object and its underlying geometry.
8. On the Edit Polygons rollout, click the Settings button next to Inset.

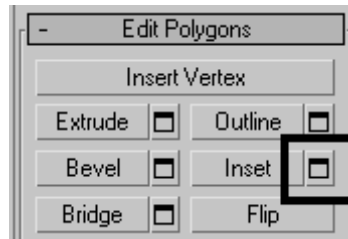

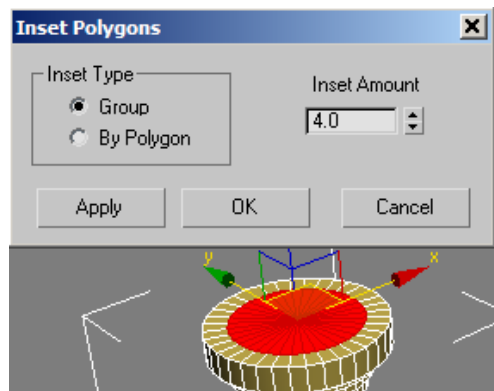

9. In the dialog that appears, set Inset Amount to **4.0**.



10. Click OK to close the dialog and save the inset.

Create the battlement:

1. Open the Modify panel, if necessary.
2.  On the Selection rollout, make sure you're at the Polygon sub-object level.
3.  Use the Select tool to select four adjacent polygons in the outer ring.

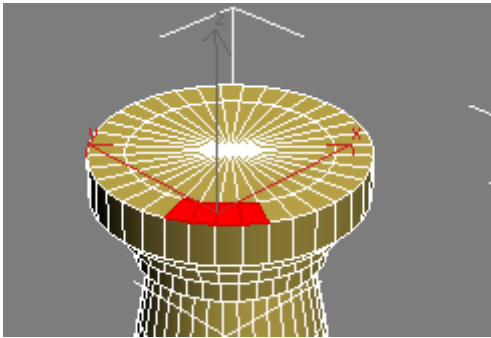

4. Skip the next two polys and then select the four after those. Repeat the procedure around the circumference until the selection resembles the following illustration:

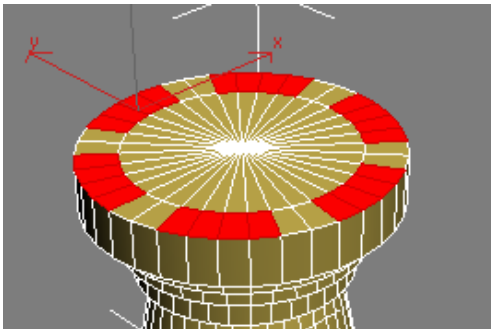

5. On the Edit Polygons rollout, click the Settings button next to Extrude. On the dialog that appears, set the Extrusion Height value to 4.5 to match the height of the battlement in the reference image in the Front viewport (change the value if necessary). When you are finished,

click OK to save the extrusion and exit the dialog.

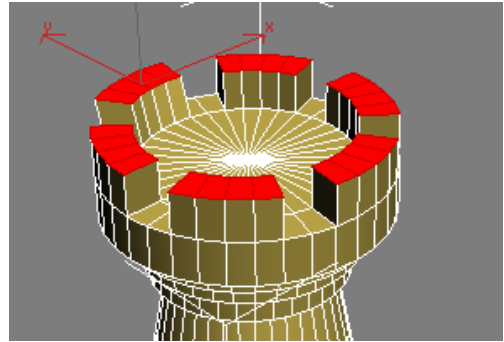

6. On the Selection rollout, click the Polygon button to exit this level.
7. Press F4 to exit Edged Faces display.
Note the faceted effect on the battlement. You will fix that in a moment.

Adjust smoothing groups:

1. Make sure the rook object is still selected and that you are still at the Modify panel.
2. From the Modifier list, choose Smooth. The entire rook now appears faceted.



3. In the Parameters rollout, turn Auto Smooth on and leave Threshold at the default value of 30.0. Any two adjoining faces that meet at an angle less than that value will be made part of

the same smoothing group and no edge will appear between them.

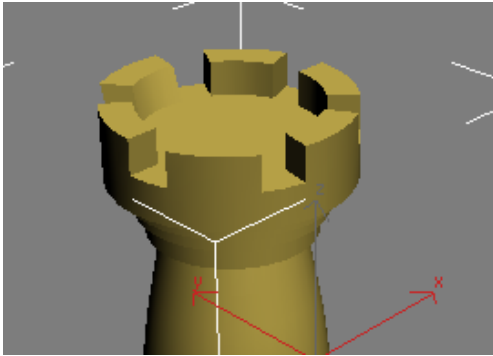

The rook appears smoother now.

Summary

In this lesson you learned to create new geometry using face extrusion. You also learned how to use smoothing groups to give your objects a smoother look.

Modeling a Knight

In this lesson, you will create a knight for a chess set using custom splines and the Surface modifier. The Surface modifier makes a 3D surface from an arrangement of intersecting splines.



Modeling a knight presents a special set of challenges: its unique contours demand that it be sculpted carefully. The Surface modifier is ideal for this type of modeling.

Features and techniques covered in this lesson:

- Building a spline cage.
- Refining and Connecting spline vertices with new segments.
- Applying and adjusting the Surface modifier.
- Using the Symmetry modifier.
- Extruding patches using the Edit Patch modifier.

Skill Level: Intermediate

Time to complete: 1 hour

Set up the lesson:

- Load the file *knight_start.max* from the *intro_to_modeling* folder.

The scene is empty except for a background picture that you will use as reference as you model the knight. If you cannot see the reference picture, follow these steps.

1. Make sure the Front viewport is selected and then press **ALT+B**.
2. On the dialog that appears, click the Files button.
3. Locate the *ref-chess.jpg* image in the *intro_to_modeling* folder and double-click it.

Draw the knight outline:

1. Maximize the Front view by pressing **ALT+W**.

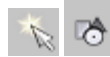

2. On the Create panel, click Shapes, and then click Line.

3. On the Creation panel > Creation Method rollout, set both Initial Type and Drag Type to Smooth. This will help set the base profile, given the curved nature of the chess piece.

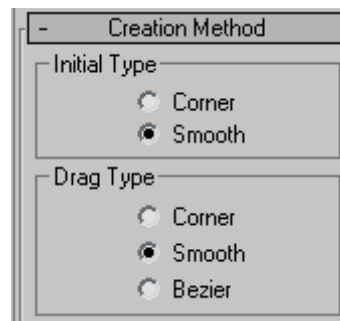

4. Click to create a contour for the knight. Do not take into account the horse's mane or the base for now. Keep in mind that this kind of modeling does not require a lot of detail, so try

to keep the number of vertices to a minimum. You will adjust them later.



5. Make sure you close the spline by clicking the starting point.
6.  Go to the Modify panel. On the Selection rollout, click Vertex.
7. Adjust the positions of the vertices around the shape of the knight. Select the following vertices.

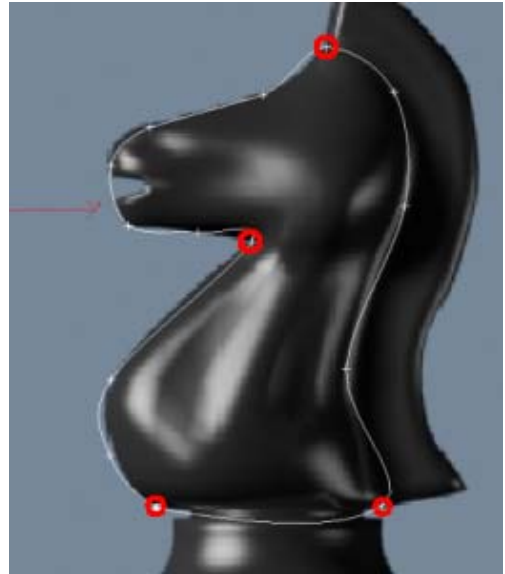

8. Right-click and choose Bezier Corner from the quad menu.
9. Use the Select And Move tool to adjust the vertex handles so that the profile fits the reference image better.

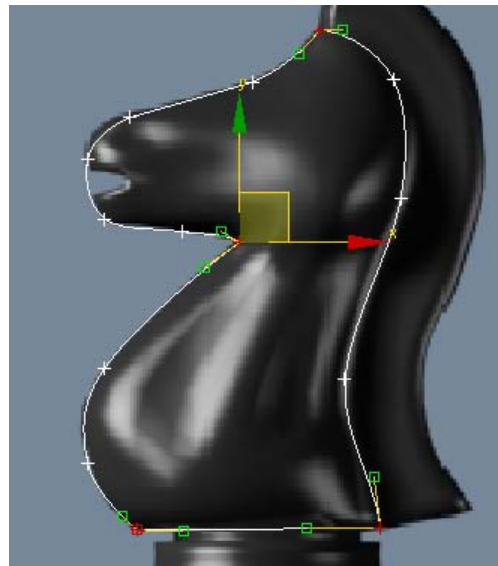

Create the inner spline cage:

1. You will start adding detail where the head intersects the neck. On the Modify panel > Geometry rollout, turn on Connect and then click Refine.

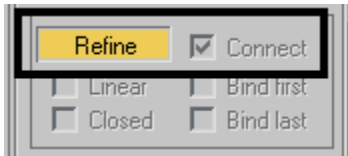

Note: Refine adds vertices to a spline. If the Connect option is on, all inserted vertices will be connected by segments in the order they were created.

2. Click the Bezier Corner vertex at the intersection of the head and the front of the neck.

A dialog opens:

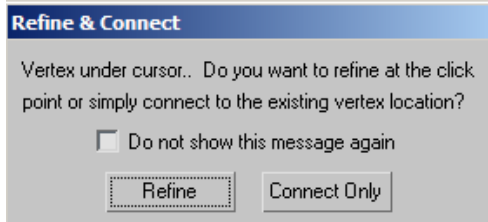

This dialog points out that there is already a vertex where you clicked. You still have the option to refine the spline, adding yet another vertex very close to the existing one, or you can simply use the existing vertex and connect it to others you will be inserting. Typically, use the Connect Only method when this warning appears.

3. Turn on the “Do not show this message again option” and click Connect Only.
4. Click a point to the right at the back of the neck.

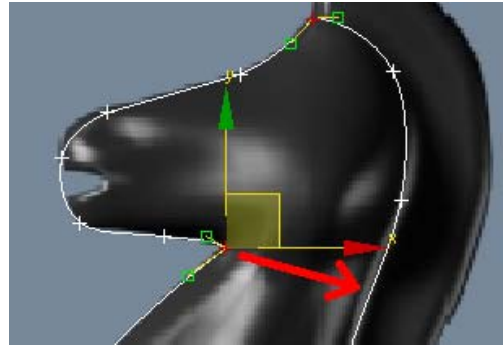

5. Right-click to finish the command. You now have an additional segment going from the front to the back of the neck.

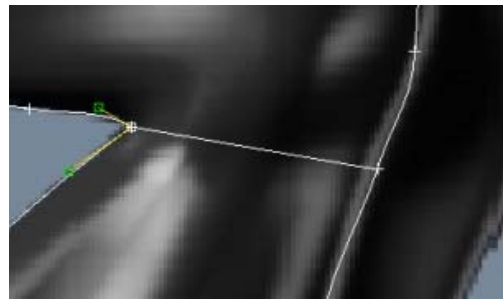

6. Add two more “levels” to the neck as shown in the illustration below.

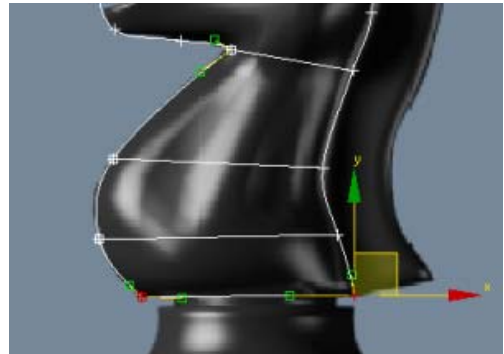

7. Use Refine/Connect to add a vertical line of detail going from the neck to the head.

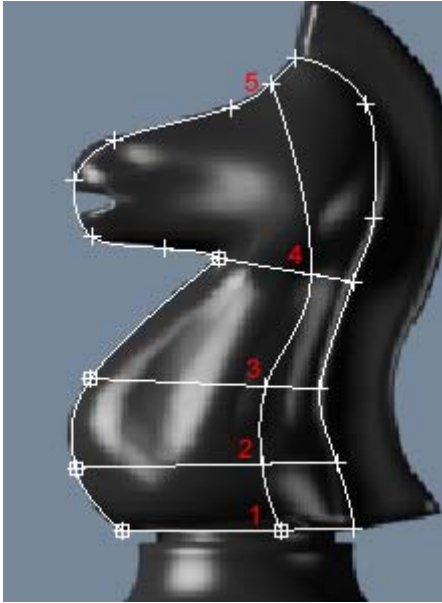

8. Continue adding detail until the spline cage looks similar to the following illustration.

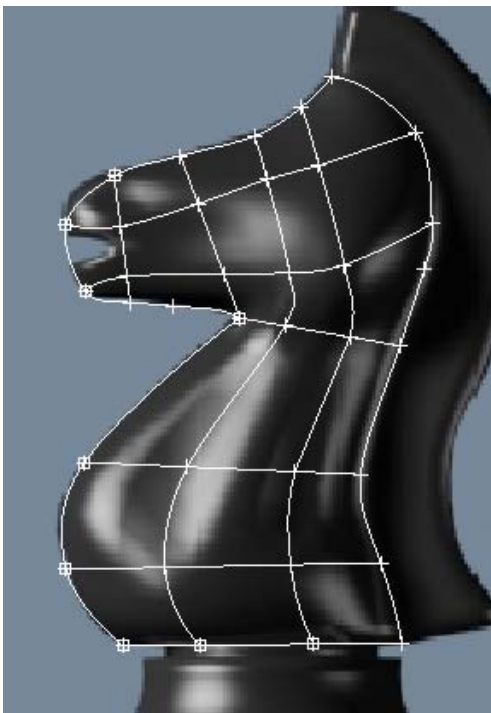

Delete unwanted vertices:

The next step is to ensure that there are no loose vertices on the spline cage. In this method of modeling, it is essential that the spline cage is made of three- or four-sided areas only.

1. Make sure the spline is still selected and that you are still at the Vertex sub-object level.
2. Look for any loose vertices and select them.
3. Press Delete to remove the unwanted vertices. Make sure that a quad area has no more than four vertices, where segments intersect.

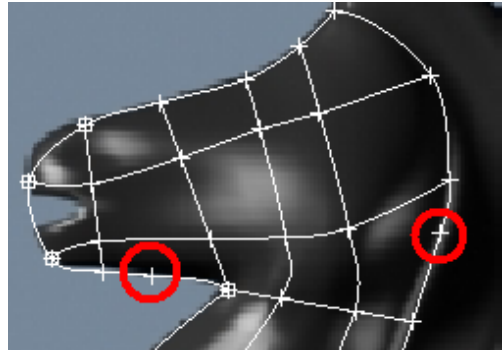

Fine-tune the spline cage:

The next step is to adjust the spline cage to get a nice flow of segments. When you refined the spline cage, you introduced a number of intersecting segments and subsequently a number of intersecting vertices. It is very important that these vertices which share the same position in space be moved together.

1. Make sure the spline is still selected and that you are still at the Vertex sub-object level.
2. In the Selection rollout, turn on Area Selection and leave the value at 0.1. This ensures that when you select a vertex by clicking it, all vertices that are within the distance specified in the threshold value get selected as well.

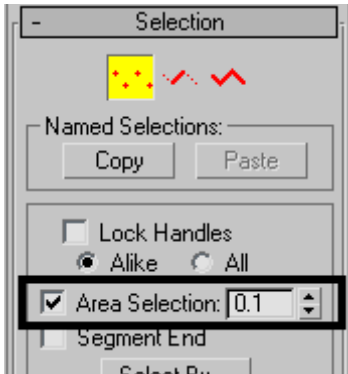

3. Use the Select And Move tool to relocate vertices to get a nice flow of segments in the spline cage.

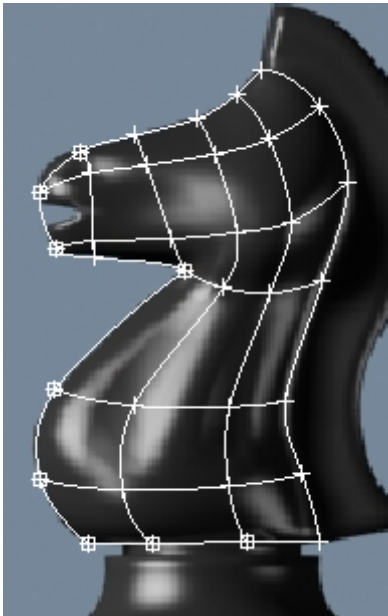

Give the spline cage volume:

So far, you've built everything in the Front viewport. The collection of segments lies therefore in the same plane. In this step, you will adjust the spline cage so that it starts shaping into a 3D volume.

1. If the Front viewport is still maximized, press **ALT+W** to return to the four-way viewport layout.
2.  Click Zoom Extents All to see the spline cage in all four viewports.
3. Using the Select tool and the CTRL key, select all the internal vertices plus the two center ones on the bottom segment.

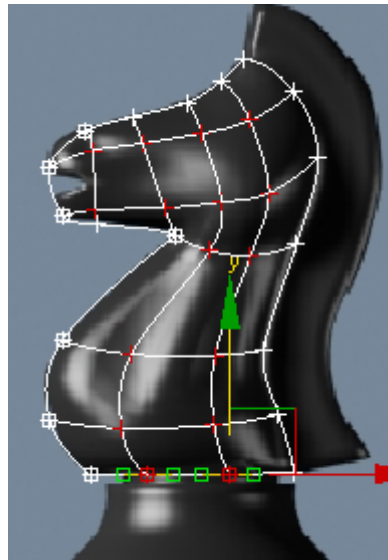

4. In the Top viewport, move the selected vertices down on the Y axis (green axis).

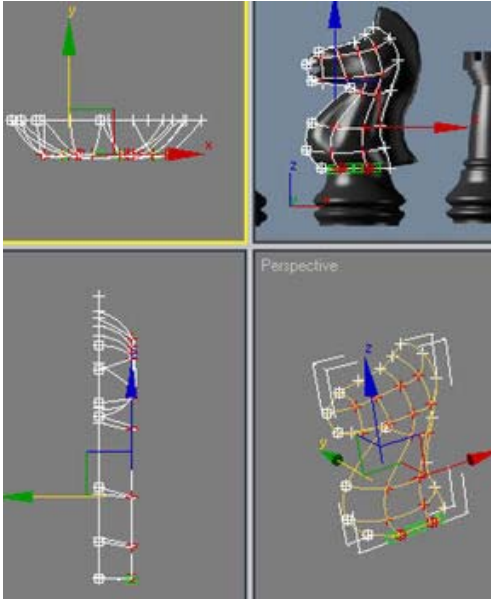

- Keep adjusting the position of these inner vertices to give the volume a more interesting shape (narrower snout, thicker bottom neck, and so on). Feel free to experiment but do not move the other vertices around the perimeter; you'll need them to mirror the object later.

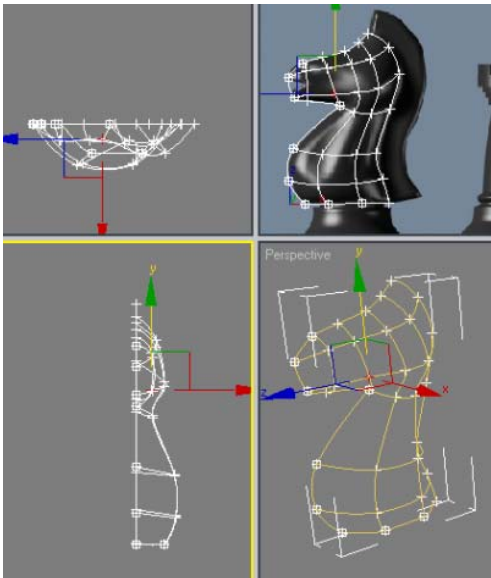

Adjust the tangents on the perimeter:

- Select all the vertices that run along the back of the neck, except for the top one.



- Right-click in the viewport and convert the selected vertices to Bezier Corner.
- Move the angled tangents so they are in a more vertical position. This will give the segments a stronger angle of attack as they meet the mirror line.

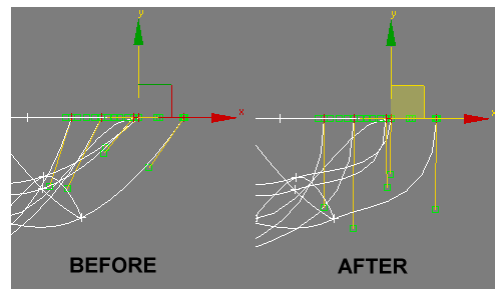

Tip: If you try to move the tangents and find the direction locked in one axis or another, press **F8** to constrain motion to the XY plane.

- Repeat this procedure on the two vertices near the mouth, and those running up the front of the neck.

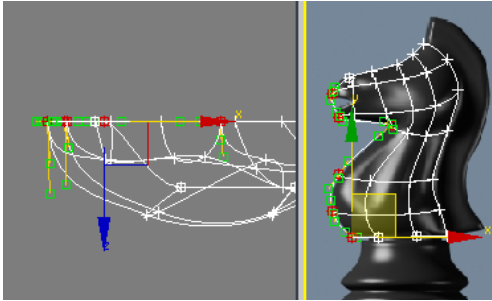

- Repeat the procedure on the vertices running along the top of the head, but then use the Front viewport to make the tangents horizontal.

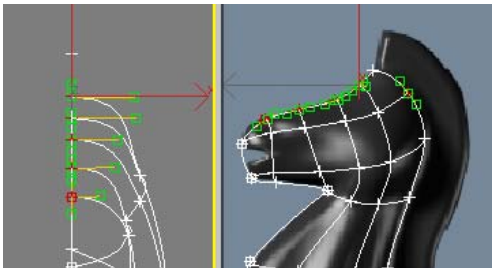

Test the Surface Modifier

You will eventually mirror this spline arrangement to make the other side of the knight, but before doing so, you need to check the current setup to see if the Surface modifier works on it.

The Surface modifier places a 3D surface over each set of three- and four-sided polygons formed by the splines.

The polygons must be completely closed in order for the Surface modifier to make the 3D surface. By trying out the Surface modifier now, you can

correct any “holes” in the surface before you mirror the splines.

- With *Line01* selected, exit the Vertex sub-object level.
- From the Modifier List, choose Surface from the Object-Space Modifiers section. Depending on how you built your spline cage, the appearance of the knight in the Perspective viewport might look solid or hollow.

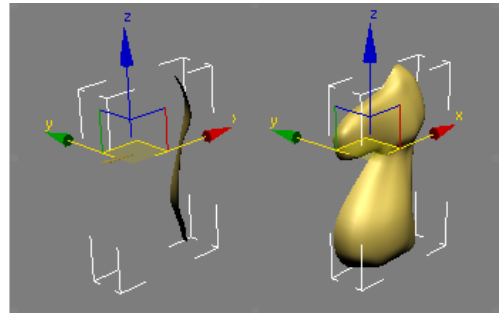

- In the Parameters rollout, try turning the Flip Normals option on or off until the knight appears as shown on the right side of the illustration above.
- Expand the Line entry in the modifier stack and then click Vertex. Turn on Show End Result so you can work on the spline cage and see the effect of the Surface modifier simultaneously.

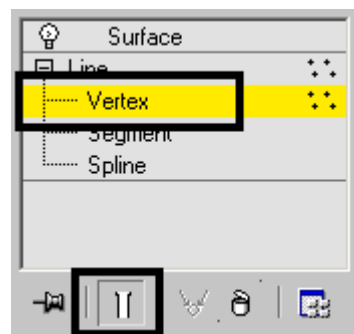

- In the Front viewport, select the vertex on the neck where you see a dip in the muscle tones.

Right-click and convert that vertex to Bezier Corner.

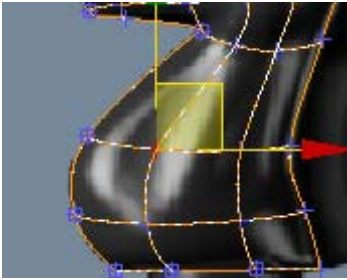

6. In the Top viewport, adjust the handles into a sharp inverted V. This will help simulate the muscle tones on the neck. Keep an eye on the Perspective viewport for reference.

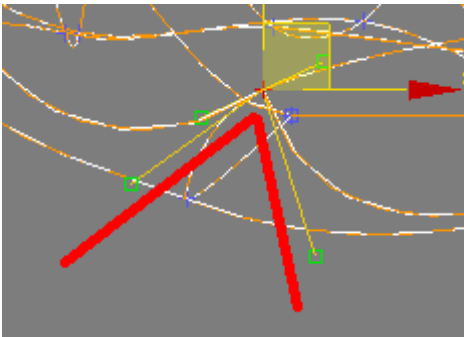

7. Experiment with this vertex and others to mold a better-looking neck. You can use this technique on other parts like the snout or the head as well.

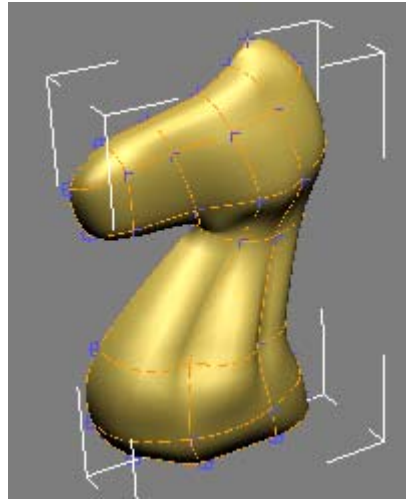

Refine the mane line:

1. Adjust the Perspective viewport so that you are looking at the back of the neck.
2. Using Connect/Refine, start from the vertex at the very top of the head and work your way down to refine a mane line as shown in the following illustration.

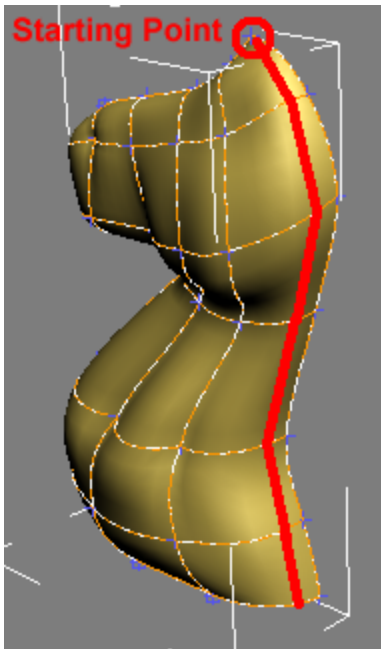

As you refine the segments, surface patches temporarily disappear from view but reappear once you finish the command. This is because you are introducing additional vertices and this creates patch areas that have more than four vertices. Once you are done refining the spline cage, however, the end result is made up of quads again and therefore displays correctly.

3. Exit the Vertex sub-object level and then click the Surface modifier to go to the top of the stack.

Mirror the spline arrangement:

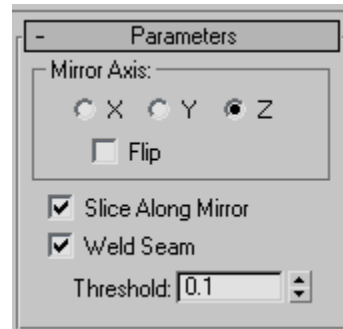

1. If you haven't done so already, highlight the Surface modifier on the modifier stack.
2. From the Modifier list choose Symmetry.
3. On the Parameters rollout, set Mirror Axis to Z.

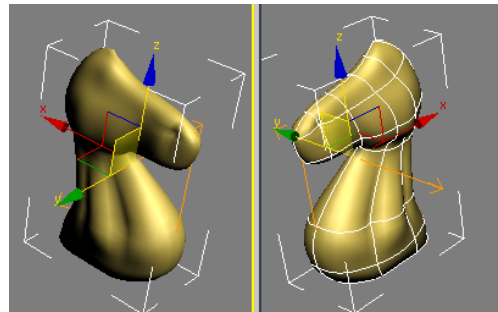

4. Orbit around the object in the Perspective viewport to see the full 3D object.



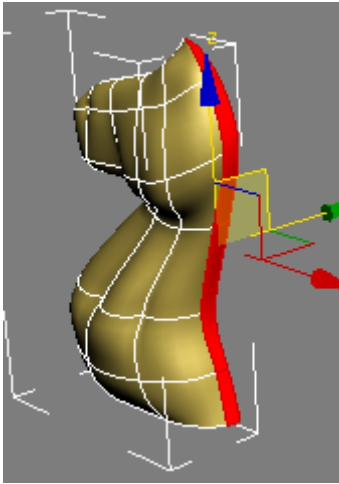

Extrude and adjust the mane:

1. Highlight the Surface modifier on the modifier stack. From the Modifier list, choose Edit Patch. This inserts an Edit Patch Modifier above the Surface modifier and below the Symmetry Modifier.
2.  If necessary, turn off Show End Result. You should be able to see only one half of the knight in all viewports.
3.  On the Selection rollout of the Patch modifier, choose the Patch button.
4. In the Perspective viewport, select the patches that make up the horse's mane.

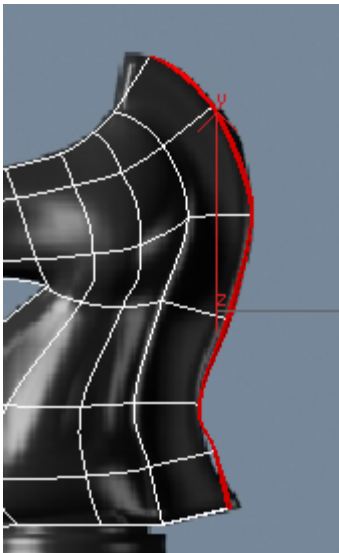

5. In the Geometry rollout > Extrude & Bevel group, click the Extrude button.
6. Bring the cursor close to the selected patches in the perspective view and then click and drag to extrude the patches. Keep an eye on the Front viewport for reference.



7.  On the Selection rollout, switch from Patch to Vertex and turn on Show End Results.

Because of the direction of the extrusion, you need to adjust the vertex position to give the Symmetry modifier a little help.

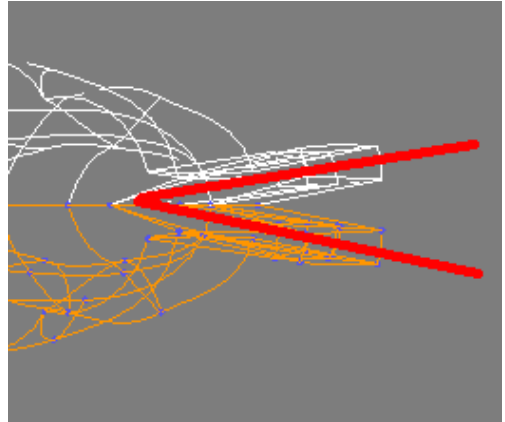

8. In the Front viewport, use region selection to select all vertices on the outer edge of the mane. Use the CTRL key if necessary.

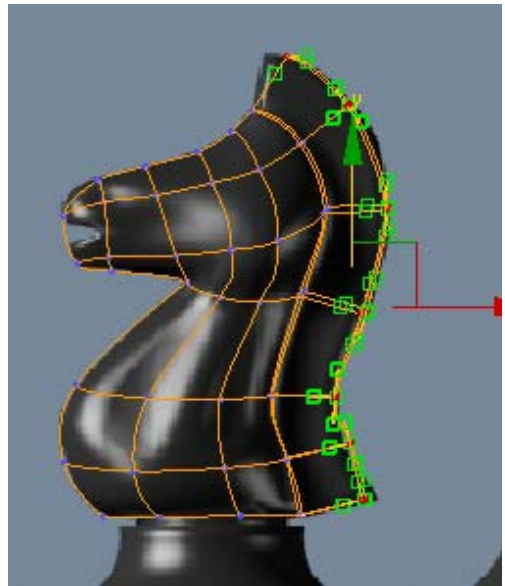

9. In the Top viewport, move the selected vertices up until they intersect along the mirror line. Keep an eye on the other viewport to see if the

Symmetry modifier worked nicely to weld the seams.

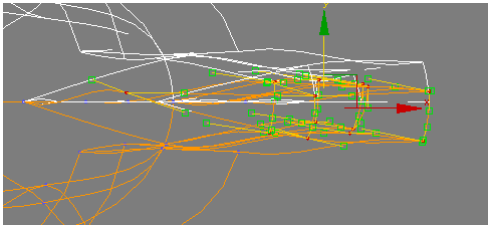

Note: This was a rather simplistic way of adjusting the mirror line. Ideally, you want to move the vertices individually or in groups, while at the same time adjusting tangents for better effects.

- Adjust the positions of the vertices and tangents in the Front viewport to follow the reference image and create a nicely flowing mane.

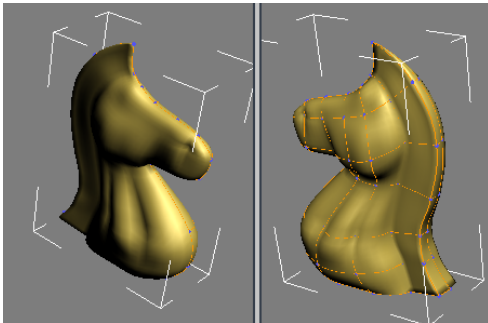

Create the base:

Even though you could have created the base as part of the same spline cage, it is easier to build it as a separate object and then attach the two objects together as a single mesh. The base is a simple lathed object, much like the ones you created in the previous lessons.

- From the Create menu, choose Shapes > Line.
- On the Creation Method rollout, set both the Initial Type and Drag Type to Corner.
- In the Front viewport, click a point in the top center of the base, just below the knight.

- Hold down the SHIFT key to constrain the line to the vertical direction, and then click a point at the bottom center of the base.
- Move to the right and click a point at the bottom-right corner of the base.
- Release the SHIFT key and go up the right side to create a rough profile of the base. Make sure you close the spline when you are done.

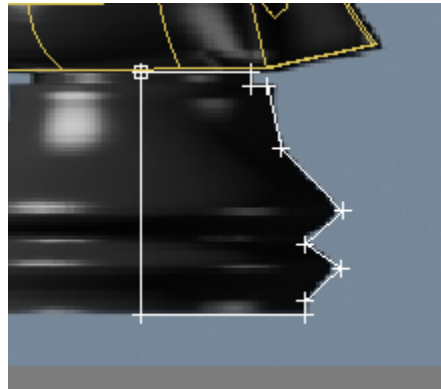

- Go to the Modify panel. On the Selection rollout, choose Vertex.
- On the Geometry rollout, choose Fillet.
- Use the Fillet tool to round off the vertices that need it.

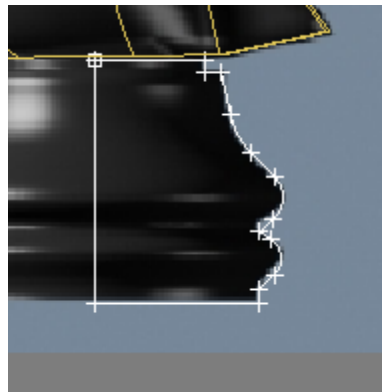

- Exit the Vertex sub-object level.
- From the Modifier list, choose Lathe.

- Set the Segments to **32** and turn Weld Core. In the Align group, click Min.

Note: If you need further detail on how to create a lathed object, refer to the first lesson in this tutorial: Modeling a Pawn.

Turn the two objects into a single mesh:

- Make sure the base is still selected. Right-click it and from the quad menu, choose Convert to > Convert to Editable Mesh.
- On the Edit Geometry rollout, click Attach and then click on the knight in any viewport.
- Change the object's name to **Knight**.

The knight is now complete.



Summary

In these lessons, you created four chess pieces, learning different tools and methods in each case. Creating a pawn taught you about working with splines and the lathe modifier. Creating a bishop and a rook taught you about editing geometry and using Boolean compound objects to add or subtract components. Finally, you learned to model using a spline cage approach using the Surface modifier with spline objects.

Modeling an Airplane



Lockheed P-38 Lightning model

In this tutorial you will create the exterior of a classic, WWII airplane, the Lockheed P-38 Lightning. You'll use primitive objects and modifiers to create the parts. Viewport background bitmaps will act as guides to help you shape your plane.

Note: This tutorial is a basic tutorial, but we suggest that you do this after completing the *Animated Still Life* (page 3–16) lesson found in the “Getting Started with 3ds Max” tutorial. You'll need to know how to select objects and vertices and navigate around the viewports.

Skill Level: Beginner to Intermediate

Time to complete: 1 hour 30 minutes

Features Covered in This Tutorial

Upon completion of this tutorial, you will be able to:

- Set up the viewports with background images to help in building the model.
- Use primitive objects as the basis for each part of the airplane.
- Edit the model at sub-object levels.

- Adjust the pivot point and hierarchy of the model in preparation for use with a game engine.

Tutorial Files

All the necessary files to do the tutorials can be found on the Tutorial Files CD, in the `|tutorials|p38_lightning` folder. Before starting any tutorials, copy the `|tutorials` folder from the CD to your `|3dsmax8` local installation.

Setting Up the Airplane Scene

The first task is to set the modeling units to meters and create a calibration box. Aircraft designers have always used the metric system for specifying dimensions. As a default, 3ds Max is set to generic units, so you'll need to change this.

Set up units of measurement:

1. From the Customize menu, choose Units Setup.

The Units Setup dialog appears.

2. Choose Metric, then click OK.

Now when you create anything, the dimensions will be displayed in meters.

3.  In the Create panel, on the Object Type rollout, click Box.

Look at the Parameters rollout; the size values are now displayed in meters.

The next step is to set up the viewport backgrounds.

Build the calibration box:

An actual P-38 has a wingspan of 15.85 meters, and a length of 11.532 meters. With the wheels extended, it has a height of 3 meters. You'll use this information to make a box of that size so you can get an idea of how much space the model will take up.

1. Activate the Top viewport.

2.  In the Create panel, on the Object Type rollout, click Box.

The Box button turns gold to show it's active and ready to create.

3. Open the Keyboard Entry rollout, and enter the following values (you needn't type the "m"; 3ds Max adds it automatically when you press ENTER or TAB):

- Length: **11.532m**
- Width: **15.85m**
- Height **3m**

Tip: You can use the TAB key to move from one field to the next.

4. Once these values are entered, click Create.

A box appears in the viewports.

5. In the command panel, name the object **calibration box**.

6.  In the viewport navigation controls at the bottom-right corner of the interface, click Zoom Extents All.

The box is now visible and centered over the three background bitmaps. It doesn't matter if your box is a different color than the one in the illustration.

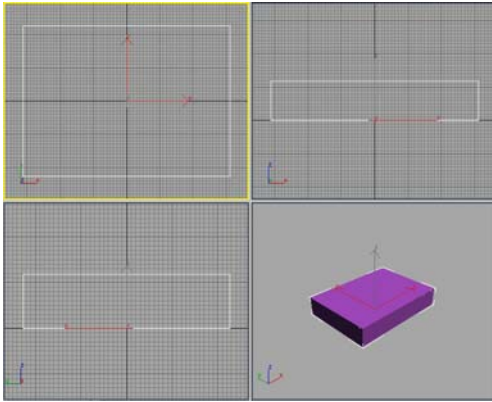

The calibration box.

Setting Up Viewport Backgrounds

You can load images or drawings in viewport backgrounds to use as patterns for building your airplane. Each viewport can have its own background, so you can load a corresponding image in the Front, Side, and Top viewports to guide you as you build your model.

In general, when modeling something you've previously visualized or seen, it's best to start with sketches from several different viewpoints, such as top, side, and front. Also, the drawings should all be to the same scale, if possible. In this lesson, you'll use three drawings of an P-38 Lightning taken from WWII plane-spotting cards.

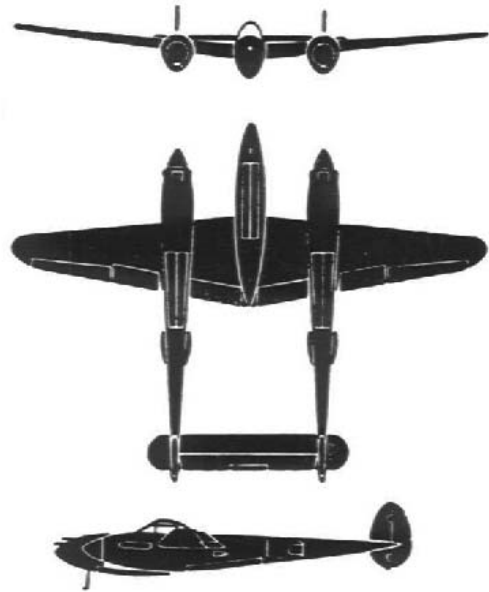

Three views of the P-38 Lightning from a set of plane-spotting cards

Set up viewport backgrounds:

1. Move your cursor to the Top viewport and right-click to make it active.
2. On the menu bar, choose Views > Viewport Background.

Tip: You can also use the keyboard shortcut, **ALT+B**.
3. In the Viewport Background dialog's Background group, click Files.
4. Navigate to the `|tutorials|p38_lightning` folder and choose `p38topview.jpg`. Click Open.
5. In the Aspect Ratio group, choose Match Bitmap. Click OK.

A sketch of the top view of the fighter is visible in the Top viewport and the Viewport Background dialog closes.

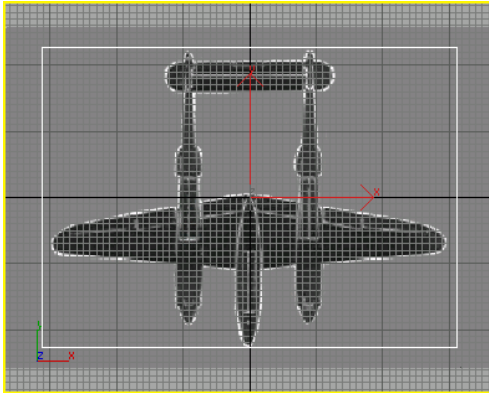

Top viewport displays the Top view background image.

6. Turn off the grid display by pressing the **G** key.
7. Choose Views > Viewport Background to again open the Viewport Background dialog.
8. At the lower left, click the arrow by the Viewport field, and choose Left.
The Left viewport becomes active.
9. Click Files and choose *p38leftview.jpg* for the Left viewport. Again, choose Match Bitmap. Click OK. Turn off the grid display again.

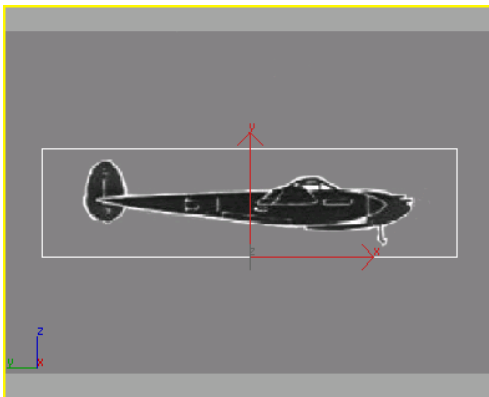

Left viewport with its corresponding background image.

10. Right-click in the Front viewport and press **ALT+B** to open the Viewport Background dialog again. Click Files again and choose *p38frontview.jpg* for the Front viewport.

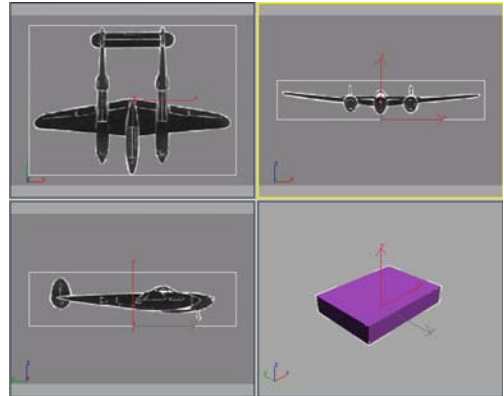

Choose Match Bitmap, then click OK. Turn off the grid display.



The three images are displayed in their appropriate viewports.

Next you will zoom and pan each view to more closely match the background images to the calibration box to make sure the three viewports are in the same scale. Each image is currently centered within the calibration box.

Calibrate the viewports:

1. Activate the Top viewport.
2.  In the viewport navigation controls, at the lower right, click Zoom. Zoom the Top viewport until the width of the box matches the width of the wings. Match the wingspan as closely as you can.
3.  Click Pan in the viewport controls, and then pan the viewport to center the box over the bitmap vertically. It won't be perfect, the two rudders will extend slightly beyond the calibration box.

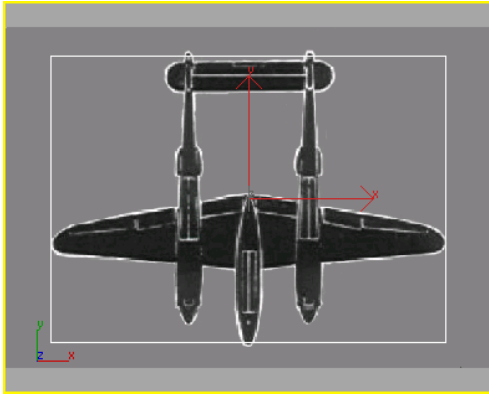

Top viewport aligned with calibration box

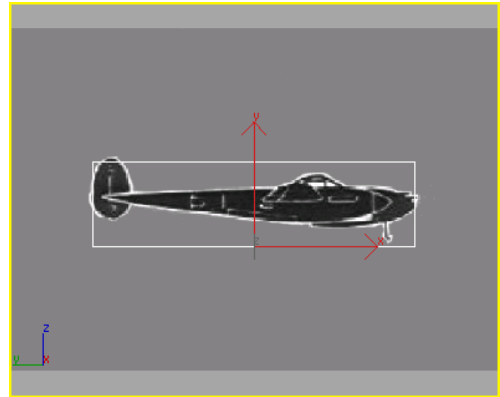

Left viewport aligned with calibration box

4. Zoom the Front viewport. Again match the wingspan first using zoom, then pan to adjust the vertical height. Since the landing gear is not shown in the plane-spotting card, align the top of the box with the tops of the rudders.

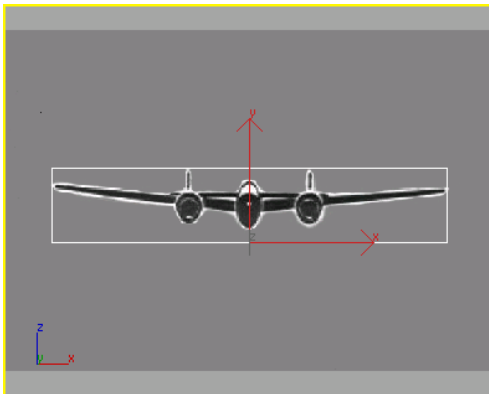

Front viewport aligned with the calibration box.

5. Now repeat zooming and panning in the Left

All three viewports are now calibrated so the picture in the viewport represents the approximate dimensions of the P-38.

You can zoom and pan the background images in the viewport if you want to center or enlarge them. To zoom or pan the background images do the following:

Zoom the background images and calibration box:

1. Activate the Top viewport, then choose Views > Viewport Background.
2. Turn on Lock Zoom/Pan.

Turning on Lock Zoom/Pan locks the background image and objects together, so if you use the zoom or pan buttons from the viewport navigation controls, you can zoom in on the background image and objects or shift them horizontally or vertically.



This is very handy if you have a detailed background sketch and know you will be zooming in to work on objects.

3. Repeat this for the Left and Front viewports.

You will notice the background image shifts when you close the Viewport Background dialog.

Tip: Sometimes the background image can shift out of alignment with your geometry. This is inconvenient, but there is a workaround.

If you open up a saved file or notice the background image has shifted, do one of the following:

-  Use the viewport navigation Zoom and Pan buttons to make the background images the correct size and position in the viewports. Turn off Lock Zoom/Pan, and then use the same navigation tools to align the geometry with the bitmaps. You can use **CTRL+ALT+B** to toggle Lock Zoom Pan.
-  You can also move the objects in the scene to match the background image. Then if you use Zoom Extents, the image will be centered with the geometry.

Hide the calibration box:

1. You don't need the calibration box now, so you can hide it. To do so, select the box in any viewport, right-click, and then choose Hide Selection from the quad menu.

You can always unhide the calibration box and repeat the above procedure to re-calibrate. To unhide the box, go to the Display panel and choose Unhide By Name, then in the dialog, select the box.

2. Save your work as **myp38_backgrounds.max**.

Create the wing using a box:

1.  In the Create panel, on the Object Type rollout, click Box.
2. In the Top viewport, do the following to draw a box from upper left to lower right, approximately around the front wingspan:
 - Click once at the upper left, then drag to the lower right with the mouse button down. As you move the mouse, the values for length and width change in the parameter fields.
 - When you release the mouse button, you have set the length and width of the box, and now are setting the height, which you can see increasing in the Perspective viewport. Moving the mouse up creates a positive height, moving down creates a negative height. As you move the cursor the values change in the parameter fields.
 - Click again to set the height.
3. In the Create panel, you can immediately adjust the values in the Parameters rollout. Enter the following values:
 - Length=**3.048m**
 - Width=**15.85m**
 - Height=**0.305m**
 - Length Segs=**3**
 - Width Segs=**12**
 - Height Segs=**3**

Creating the Wings

There are many different modeling approaches you could take to building the wings. Here, you'll use a Box primitive with a Taper modifier.

You'll be continuing from the previous section, *Setting Up Viewport Backgrounds (page 1-48)* or open *p38_calibrated_start.max* from the *|tutorials|p38_lightning* folder.

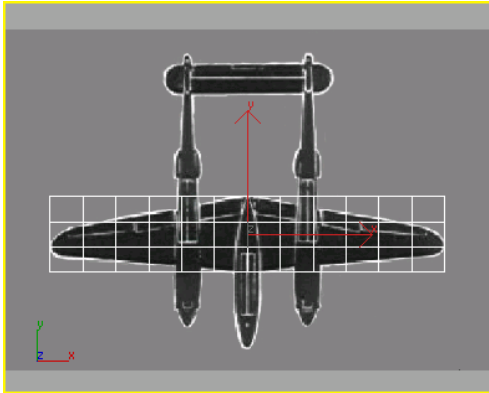



The Box with 12 width and 3 length segments.

You need to increase the number of segments so the modifiers for tapering and bending the wings will work correctly.

- In the Name and Color rollout, type **wing**.
The object is now named *wing*.
Next you'll change the shape of the wing's profile so it looks like an airfoil.

Shape the wing into an airfoil:

- Activate the Left viewport, and make sure the wing is selected.
-  From the viewport navigation controls, click Zoom Extents.
You'll zoom in on the wing object.
- From the menu bar, choose Modifiers > Mesh Editing > Edit Mesh.
You'll need this to perform some sub-object editing to the vertices that make up the wing.
-  In the Selection rollout, click the Vertex button.

Look at the box in the Left viewport with vertex selection on. Each tick you see is actually twelve vertices lined up on top of one another. When you want to select and move them, you need to drag a selection window around them.

Otherwise you will only select one vertex, rather than all of them.

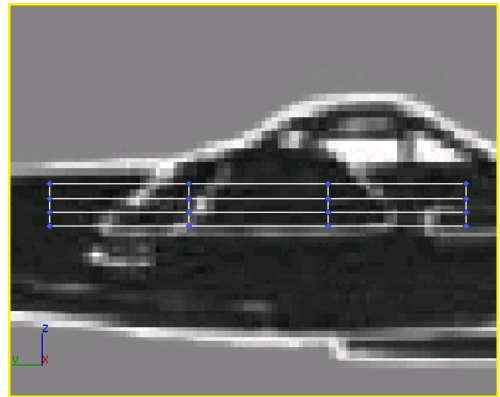

The vertices appear as blue ticks at every intersection of the model.

- Draw a selection window around the upper right set of vertices.
The X,Y,Z tripod jumps to the selection set and the selected ticks turn red.

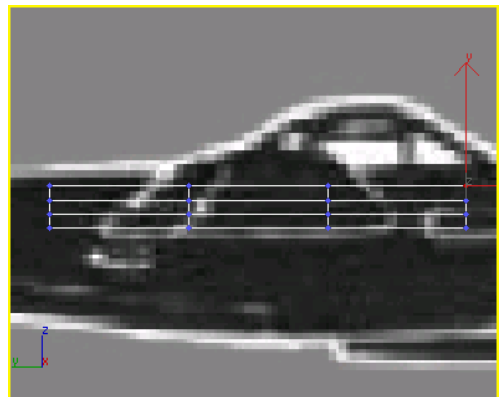

Selected vertices display in red.

- Hold down the CTRL key and drag a selection window around the vertices at the lower right.
The CTRL key allows you to add to an existing selection set. The X,Y,Z tripod jumps to the center of the selection set.

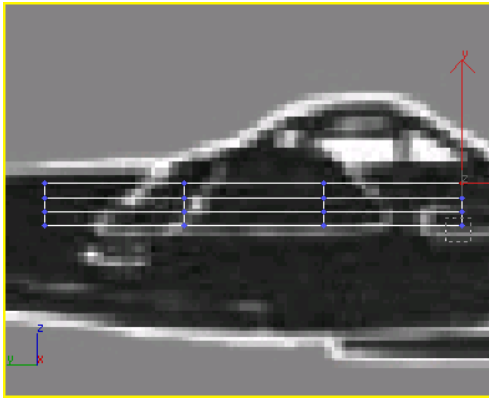

On the main toolbar, click the Select and Move button and move the cursor over the X axis of the tripod. Click and drag the cursor to the left so the leading edge of the wing looks beveled.

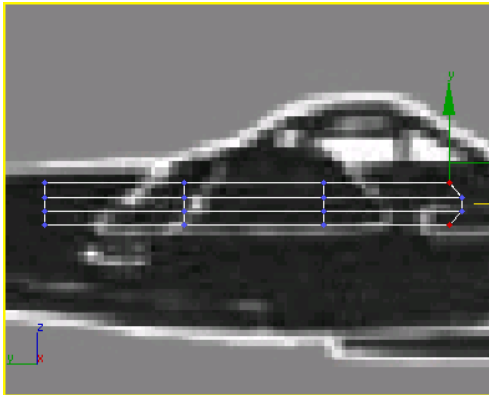

- Click Select And Non-Uniform Scale. Then scale the vertices along the Y axis to 75%.
Tip: Watch the Y field of the coordinate read out at the bottom below the time slider.

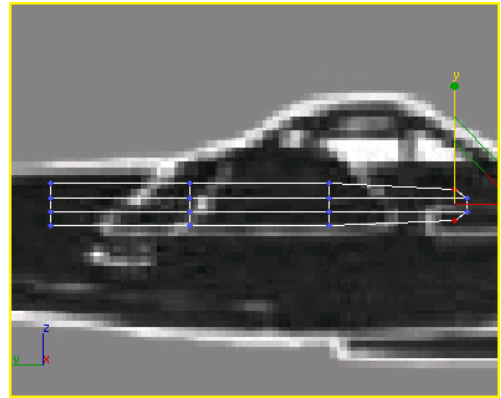

Scale the vertices to start rounding off the leading edge of the airfoil.

- Drag a selection window around all the vertices in two center columns of vertices.

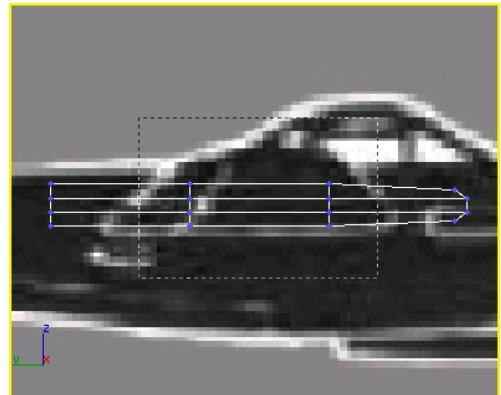

- Move this set of vertices along the X axis to the right about 0.5m.
Again, watch the coordinate readout at the bottom.

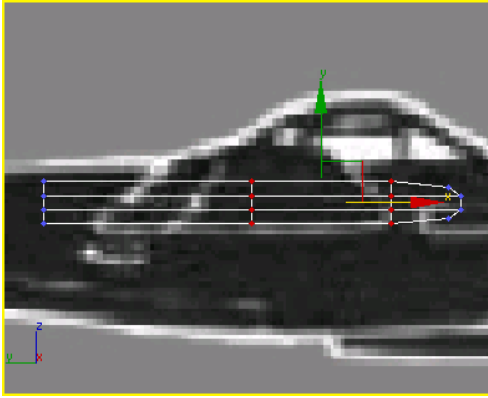

10. Drag another selection window around the vertices at the upper left corner. Then hold the CTRL key and drag a selection window around the vertices at the lower left corner.



11. Move this set of vertices along the X axis to the right about 0.8m.

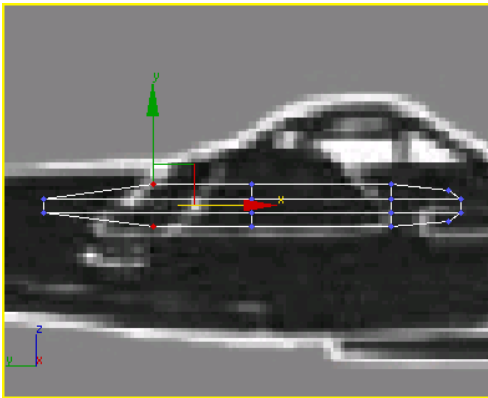

The airfoil is beginning to take shape.



12. Click Select and Non-Uniform Scale, hold down the CTRL key and drag a selection window around all the leftmost set of vertices.

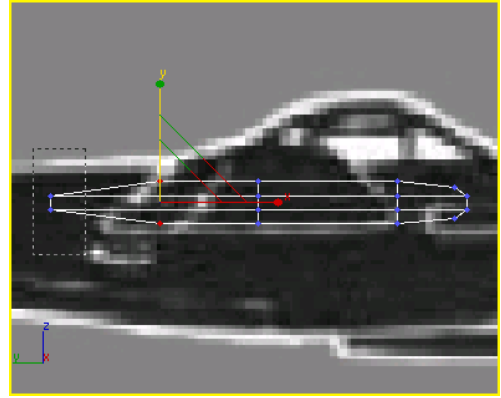

13. Scale this selection set along the Y axis to 75%

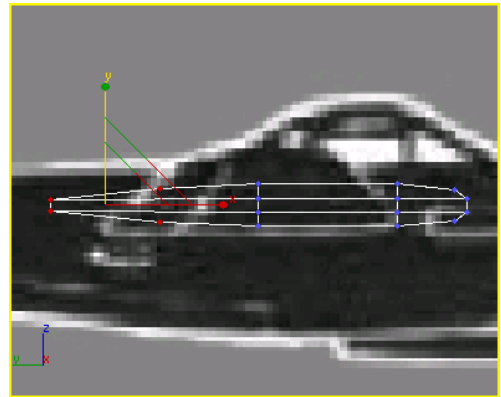

Now you've got a pretty good approximation of an airfoil.

Now that you have your airfoil, you'll make further changes to the shape of the wing using a Taper modifier.

Add a taper modifier:



1. Activate the Top viewport, and make sure to turn off Vertex mode.
2. From the menu bar, choose Modifiers > Parametric Deformers > Taper.

An orange taper gizmo appears in the viewport over the box.

3. On the command panel, in the Taper Axis group, change the Primary value to **X**.
4. In the same group, turn on Symmetry.
5. Set the amount of the taper to **-1.3**.

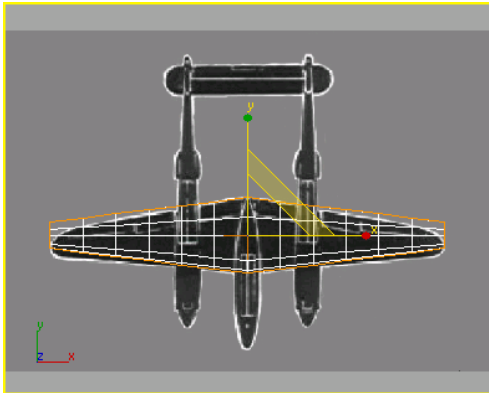

The box is starting to resemble the P-38's wing shape.

Next you'll move the Taper Center to refine the wing's shape.

6. **+** In the modifier stack display, expand the Taper hierarchy by clicking the box marked with a plus sign. When the Taper expands, click Center.

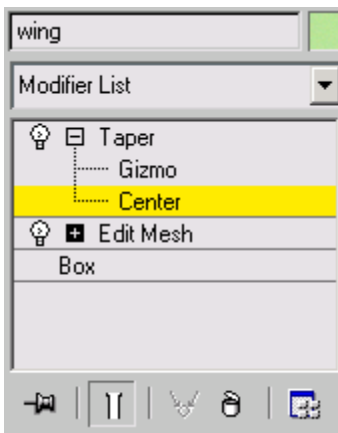

At the Center sub-object level, you can adjust the location of the center of the Taper. Moving a modifier's center will alter its results.

7. In the Top viewport, move the center of the taper forward along the Y axis toward the nose of the plane, until the wings' shape more closely matches the background image.

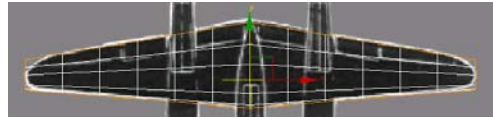

8. When you've finished moving the center, click Taper in the modifier stack to turn off the Center sub-object selection.
9. The Taper has affected the height of the wings. In the modifier stack, click Box, then increase the wing height to **0.4318m**.

Note: Since you're making a change that affects a topology dependant modifier, Edit Mesh, you'll see a warning. Click Yes to make the height change. If you're not sure, click Hold/Yes. Hold/Yes creates something like a clipboard copy of the entire scene. If the change you make is undesirable, use Edit menu > Fetch to restore the scene to its state before you made the change.

10.  Activate the Front viewport and move the wing along the Y axis so it is centered over the background bitmap.

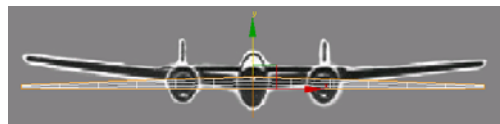

Move the wings up in the Front viewport.

Next you'll convert the box to an editable polygon object, and then move some vertices to round off the wing tips.

Convert the box:

1. Save your file as **myP38_wing.max**.

Tip: Get in the habit of saving your scene frequently at key points. Saving before converting the box is a good time, because the conversion removes the stack parameters. If, at a later time, you find that you have to make further adjustments to the Box geometry or Taper modifier, you can reload the saved model.

2. In any viewport, select the box, if it's not already selected.
3. Right-click and choose Convert to: > Convert to Editable Poly.

The box is now an editable poly object.

Round off the wing tips:

1.  In the Selection rollout on the command panel, click Vertex. Some vertices from previous operations are already selected.
2. In the Top viewport, draw a selection window to select the vertices in the upper-left corner of the wing. While holding down the CTRL key, drag another selection window around the same set of vertices at the opposite wing tip.

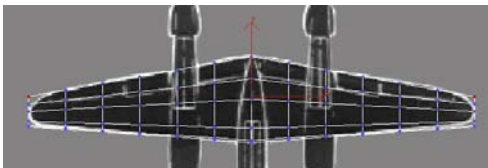

Select the vertices at each end of the wing.

3.  On the main toolbar, click Select And Non-Uniform Scale. Then use the Transform gizmo to scale the vertices in the top view so the ends of the wing tips are rounded.

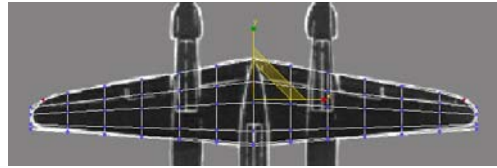

Scale the vertices to round off the wing tips.

4. Repeat the vertex selection and scaling until the wing tips are rounded.

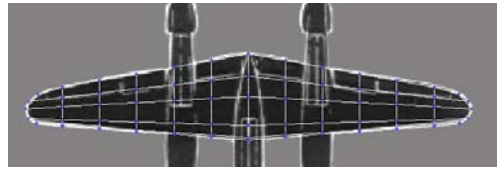

The wing tips are rounded.

In the top viewport you need to select all the vertices on the outside edges of the wings. You can accomplish this by using the selection rectangle with the CTRL key.

Add a Bend modifier:

1. In the Selection rollout, click Vertex to turn it off.
2. Click the arrow to the right of the Modifier List. In the drop-down list, find the Object-Space Modifiers group, and choose Bend.
3. Set the Bend Axis to **X**.
4. Change the Bend Angle to **-20**.

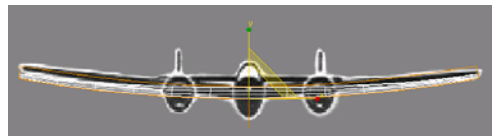

Bend the wings up.

5. Just for fun, spin the Direction spinner. Watch the wings spin in the air. Right-click or press CTRL+Z to undo when you're done having fun.
6. Save your work as **my38_wing2.max**.

Next, you'll add the stabilizers and rudders. These are easy to do.

Adding the Stabilizer and Rudders

Continue from the previous lesson, *Creating the Wings (page 1–51)* or open *p38_wing.max* from the *|tutorials|p38_lightning* folder.

In this lesson, you'll add the horizontal stabilizer and the twin rudders. You'll use cylinders and editable poly techniques to build these pieces.

Add the horizontal stabilizer:

1. Click the Top viewport to activate it.
2.  From the Create panel, click Cylinder.
3. In the Top viewport, drag out the radius of the cylinder in the center of the horizontal stabilizer. When you release the mouse button, you then drag to set the height of the cylinder. Moving the mouse upward gives a positive height; moving it downward gives a negative height. Give it a positive height.

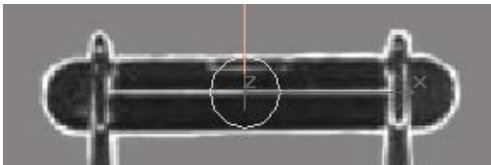

Create a cylinder to make the stabilizer.

4. Edit the Parameters, as follows:
 - Radius=**0.66m**
 - Height=**0.051m**
 - Height Segments=**1**
 - Sides=**14**
5. In the Name and Color rollout, type **stabilizer**. Naming your objects proves useful later.

6. Right-click the cylinder and choose Convert to: > Convert to Editable Poly.



7.  In the Modify panel, on the Selection rollout, click Vertex.

Now the vertices are visible in the cylinder.



8.  Select half the vertices, and move them to the right. Select the other half of the vertices and move them to the left.

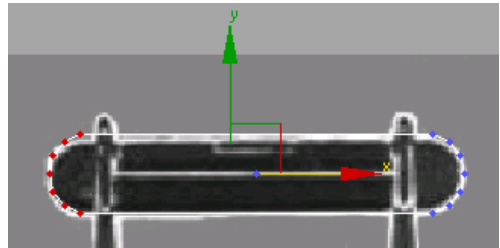
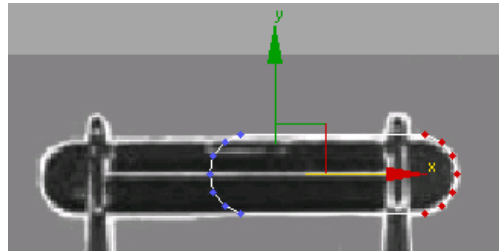

Move the vertices to match the top view of the stabilizer in the background image.



9.  Click Vertex selection again to turn it off.



10.  In the Front viewport, move the stabilizer up along the Y axis so it lines up with the background image.

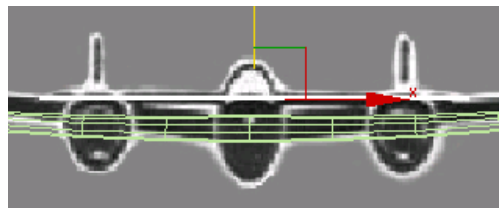

Align the stabilizer with the background image.

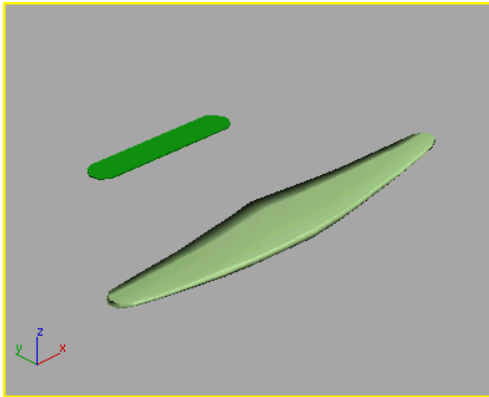

Wingspan and stabilizer in Perspective viewport

Next, you will construct the twin rudders.

Just like the stabilizer, you'll use a cylinder, converted to an editable poly object, to create one of the rudders. In this case, you'll use the soft-selection feature when you select and move vertices. After the rudder is properly shaped, you'll use the Symmetry modifier to create the second rudder.

Create the twin rudders:

1.  Click the Left viewport to active it and click Zoom Extents if necessary.
2. On the Create panel, turn on Cylinder.
3. In the Left viewport, draw a cylinder over the rudder.

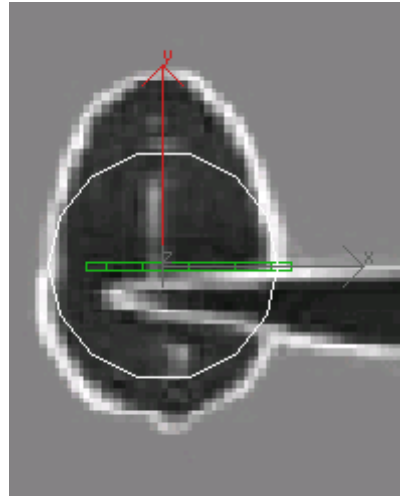

Start with a cylinder to make the rudder.

4. Set the following parameters:
 - Radius=**0.72m**
 - Height=**0.051m**
 - Height Segments=**1**
 - Sides=**15**
5. In the Name And Color rollout, enter the name **rudder**.
6.  Click the Modify panel tab, and then right-click the Cylinder in the modifier stack. Choose Convert To: Editable Poly.

The modifier stack no longer shows the cylinder; it now shows Editable Poly instead.
7.  In the Selection rollout, click Vertex.
8. In the Left viewport, drag a selection window around the top vertices.

Remember that there are vertices at the top and bottom of the cylinder, so even though a single red dot appears in the viewport, you are actually selecting two vertices.

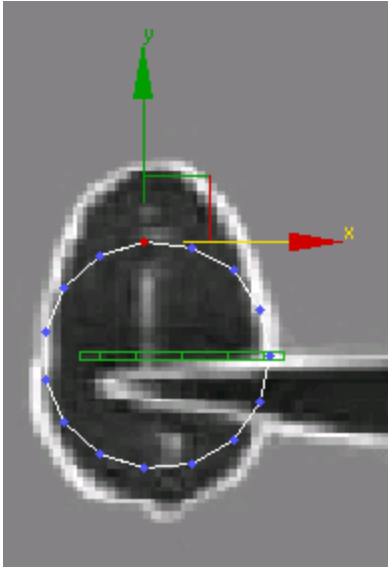

Select the top vertex.

9. Open the Soft Selection rollout, and turn on Use Soft Selection.

Now the red dot is flanked by yellow-green dots.

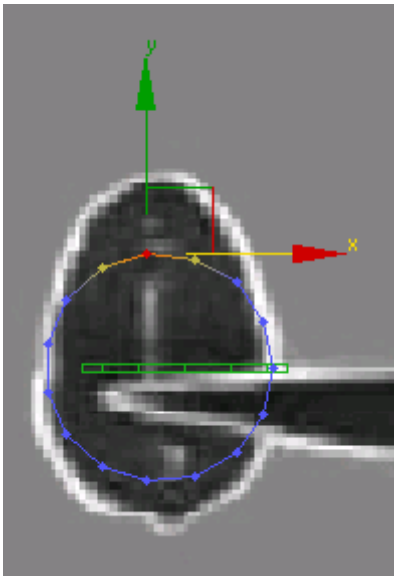

Soft Selection display

10. In the Soft Selection rollout, increase the Falloff value to 1.524m.

The selection expands in the viewport.

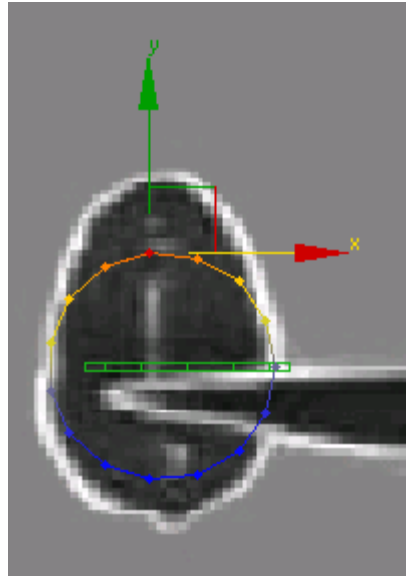

11. Using the Transform gizmo, move the selection upward to shape the rudder.

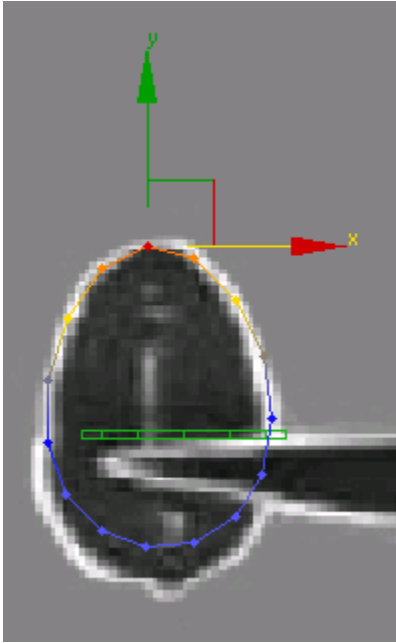

The rudder begins taking shape.

12. Select the bottommost vertex, and move it down to finish the shape.

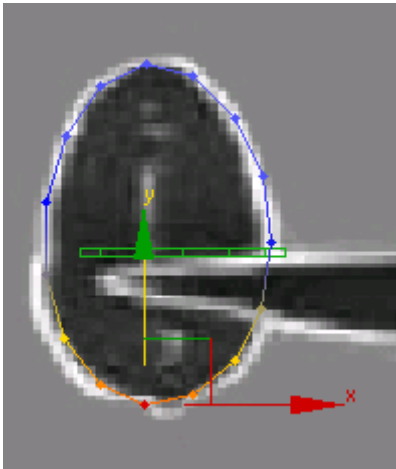



13. In the modifier stack, click Editable Poly to turn off sub-object selection.

14. In the Top viewport, select and move the rudder to the left into position.

Use Symmetry to create the second rudder:

There are several ways that you could create the second rudder but you'll use the Symmetry modifier for this part of the lesson.

1.  Make sure port rudder is selected and open the Modify panel.
2. Open the Modifier List and select Symmetry.
3. In the Parameters rollout, change the Mirror Axis to **Z**.
4.  In the modifier stack display, expand the Symmetry hierarchy by clicking the box marked with a plus sign. When Symmetry expands, click Mirror.

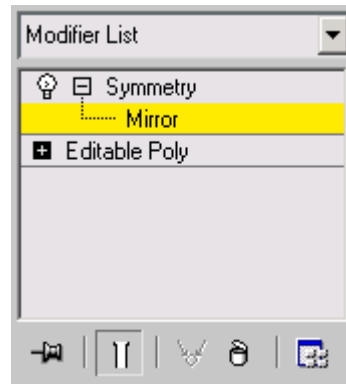

At the Mirror sub-object level, you can adjust the location of the mirror axis.

5. In the Top viewport, drag the Mirror gizmo to the center of the stabilizer. When the new rudder lines up with the background image, release the mouse button.

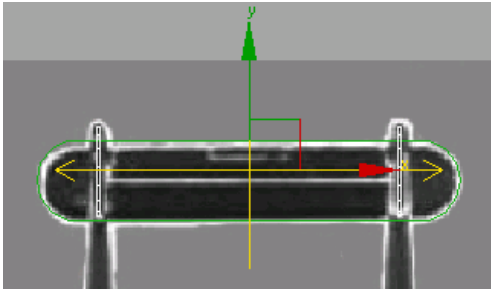

The new rudder

- Click Mirror again to turn it off.
- Rename the object to **rudders**.

The Symmetry modifier adds geometry to an existing object. It does not make a clone of the original so both rudders are treated as a single object.

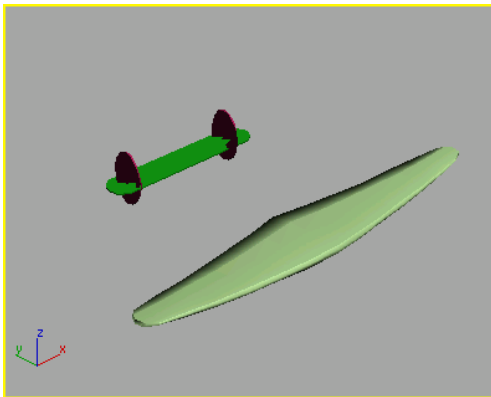

The completed tail section and wings.

- Save your work as **myp38_wing_and_tail.max**.
In the next lesson, *Creating the Sponsons* (page 1–61), you'll create the sponsons that support the tail section and house the engines.

(Optional) Separate the rudders:

It's not really necessary, but if you want to separate the rudders, you can do so by adding an Edit Mesh modifier.

- Open the Modifier List and apply an Edit Mesh modifier to the rudders.
-  From the Selection rollout, choose Element.
- In the Top viewport, select the right-hand rudder.
- From the Edit Geometry rollout, click Detach. The Detach dialog appears.
- In the Detach As field, enter the name **starboard rudder** and click OK.
- Turn off the Element button and rename the selected object as **port rudder**.

Creating the Sponsons

The P-38 was a rugged aircraft because it had twin sponsons that supported the tail, housed the engines and superchargers and contained self-sealing fuel tanks. The airplane could sustain damage to either side, and still fly, thus presenting a formidable challenge to any opponent in a dogfight.

In this lesson, you'll model the sponsons using the same techniques you've already practiced on the wing and tail section. You'll also use the Bevel tools to create the engine exhaust gates.

Create the starboard sponson:

- Continue from the previous lesson, *Adding the Stabilizer and Rudders* (page 1–57) or open *p38_wing_and_tail.max* from the `|tutorials|p38_lightning` folder.

-  On the Create panel, click Cylinder.

The Cylinder button turns gold, showing it is active and ready to use.

- In the Front viewport, drag a cylinder out over the left sponson so the radius approximates that in the background image.

Don't worry about the height, you'll adjust that in a moment. Drag the height to any value. It doesn't matter.

4. Edit the Cylinder parameters, as follows:
 - Radius=**0.558m**
 - Height=**10.0m**
 - Height Segments=**6**
 - Cap Segments=**1**
 - Sides=**12**
5. In the Name and Color rollout, enter the name of the object as **starboard sponson**.



6. In the Top viewport, move the cylinder so it is over the left sponson of the background image. Position it so the propeller spinner is visible.

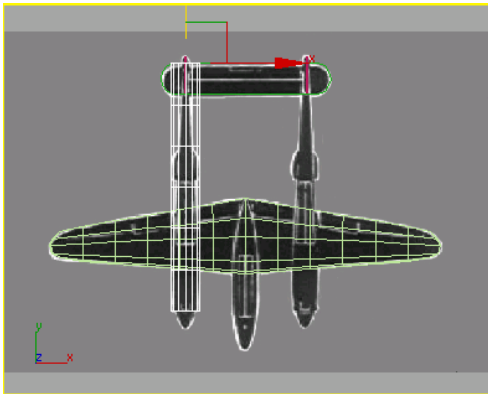

7. Go to the Modify panel. From the Modifier List, find the Object-Space Modifiers group, and choose Taper.
8. In the modifier stack, expand the Taper hierarchy so the Center and Gizmo are visible, then click the Center to select it.
9. In the Top viewport, move the center so it is at the front of the cylinder.

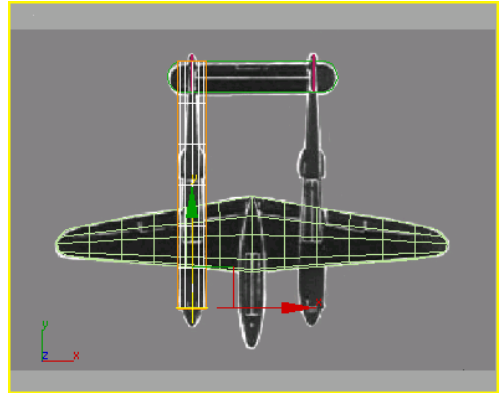

10. In the stack, click Taper to turn off sub-object selection.
11. Now adjust the taper Amount to **0.8**.

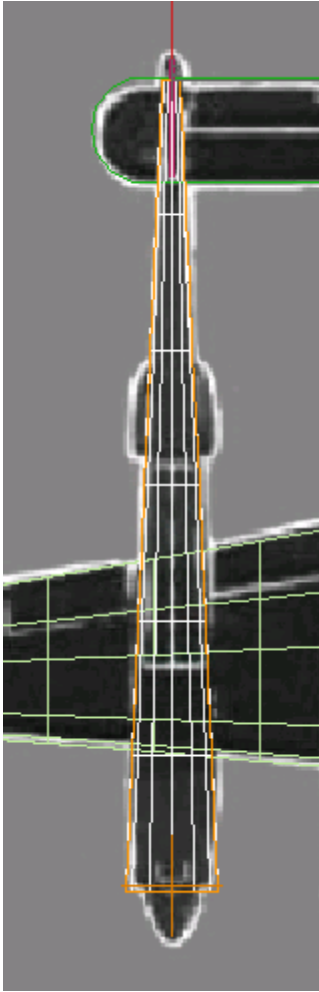

*Tapered sponson aligned with the background image.
(The front of the sponson is just behind the rounded
propeller spinner.)*

12.  In the Front viewport, rotate the sponson about 15 degrees about its Y axis so the left and right sides are vertical.

Tip: You can also enter **15** into the Y coordinate read out at the bottom to be precise.

To further shape the sponson, you'll repeat the same technique as before. Convert to Editable

Poly, then select rows of vertices and move them into position over the background image.

The propeller cap is called the “spinner”, and you'll create this component at the forward end of the cylinder using a hemisphere and AutoGrid.

Add the propeller spinner:

1.  Zoom into the Perspective viewport so you have a close view of the front end of the cylinder. Right-click the viewport label, and set the shading mode to Smooth + Highlights and Edged Faces.

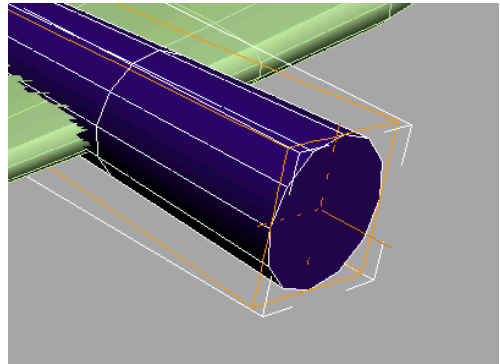

2.  Open the Create panel. In the Object Type rollout, click to turn on Sphere.
3. Turn on AutoGrid, the check box below Object Type. Now move your cursor over the surface of the end of the cylinder.

An axis tripod follows your cursor, showing you where the sphere will be drawn.

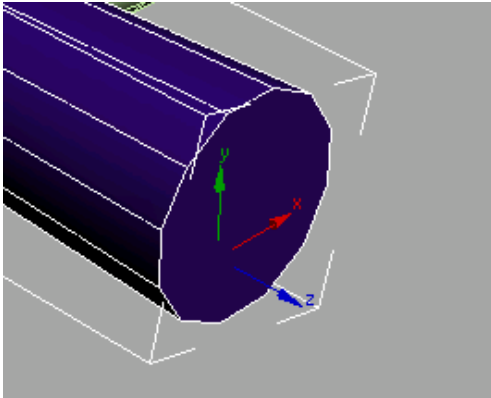

4. In the Parameters rollout, turn on Base To Pivot.

This lets you draw a sphere off the end of the cylinder.

5. Move your cursor over the end of the cylinder, and draw a sphere.

It doesn't matter what size; you will adjust the parameters after you draw it.

6. Edit the Parameters, as follows:

- Radius=**0.558m**
- Segments=**12**
- Hemisphere=**0.5**

Now instead of a sphere, there is a hemisphere.

7.  Rotate the hemisphere so the 12 segments of the cylinder and the hemisphere are at the same angle. Fifteen degrees about the Y axis.

8.  On the toolbar, click the Align button, then click the cylinder. In the Align Position (World) group, turn on X Position and Z Position. This properly aligns the hemisphere and the cylinder. Click OK

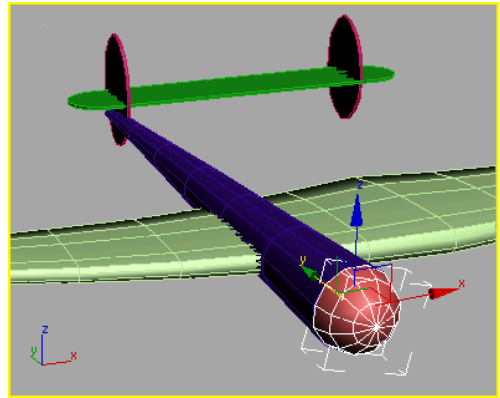



The spinner is aligned to the end of the sponson.

9. Rename this object **starboard spinner**.

10. Save your scene as **myp38_sponson.max**.



You'll be converting the sponson cylinder to an editable poly so it's a good time to save your scene.

Finish shaping the sponson:

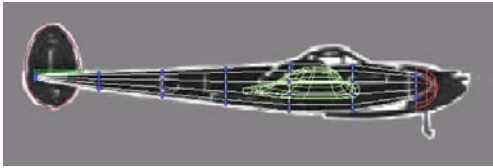
1. Select the sponson cylinder object and right-click. Choose Convert To: > Convert To Editable Poly from the quad menu.
2.  In the Selection rollout, click Vertex.
3.  In the Left viewport, select a column of vertices and then on the toolbar, choose Non-Uniform Scale from the scale flyout. Non-uniform scale them closer together, watching the bitmap as a guide. Then right-click, choose Move from the quad menu, and position the row.
4. Repeat this process for all seven columns of vertices in the Left viewport, so the outline of the sponson matches the background more closely.



Select one column at a time, scale, then move.

5.  Click the Vertex selection button to turn it off, then select the spinner hemisphere in the viewport.
6. Move the propeller spinner away so you can see the end of the sponson in the Perspective viewport.
7.  Select the cylinder again and turn on Vertex selection.
8. Select the vertices in the forward end of the cylinder and non-uniformly scale them about the X axis only. Use the Transform gizmo X arrowhead, and watch the coordinate display in the status bar. Scale down to **60** percent along the X axis.

This returns the end of the cylinder to a more circular shape.

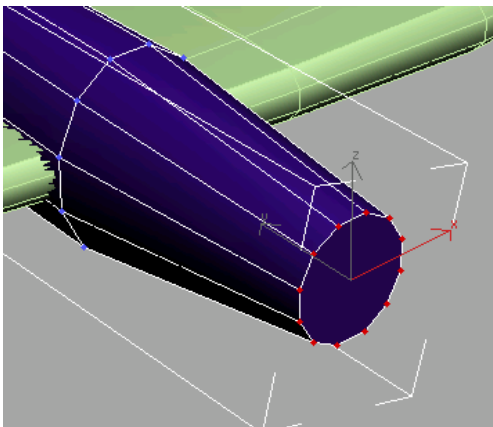

9. Turn off sub-object selection by clicking Vertex again in the Selection rollout, then move the

hemisphere back into place. Change its radius so it fits over the end of the sponson again.

Finish the propeller spinner:

1. Collapse the hemisphere to an editable poly by right-clicking, and choosing Convert to: Convert to Editable Poly.
2. In the Perspective viewport, select the vertex in the center of the hemisphere.
3. In the Soft Selection rollout, turn on Use Soft Selection and adjust the Falloff so the second ring of vertices turns yellow, but the last rows do not. Move the selection forward along the Y axis.

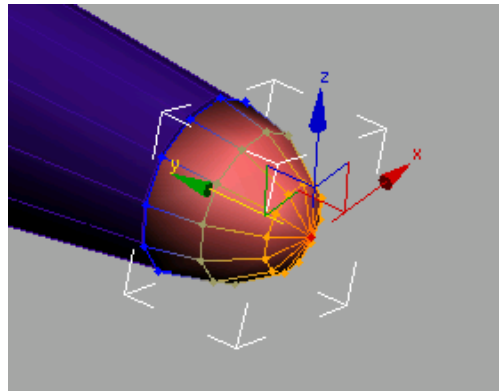

4. Lower the soft selection so only the vertex at the tip is selected, and move the tip forward to form the bullet shape.

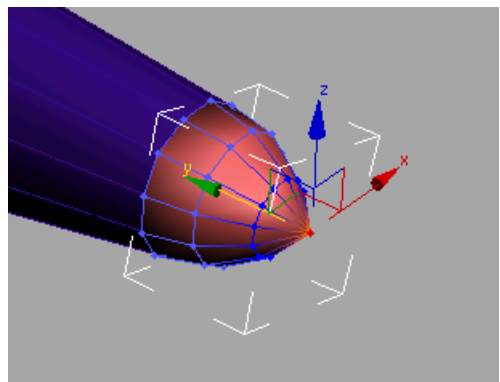

5.  Click the Vertex selection button to turn it off.

The sponson is almost finished. There is a blister on either side of the sponson that serves as the exhaust waste gate outlet. You'll create this next, using the Bevel features.

6. Save your scene as **myp38_sponson2.max**.

Create the exhaust gate outlet:

1. Select the sponson.
2.  Turn on Vertex selection for the sponson.
3. In the Top viewport, select the third row of vertices from the top and move them down so they are at the end of the exhaust gate.

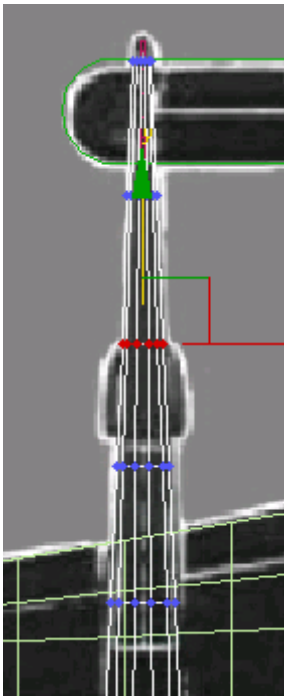

Select and move these red vertices down.

4. Select the fourth row and move them up, so they are positioned at the start of the exhaust gate.

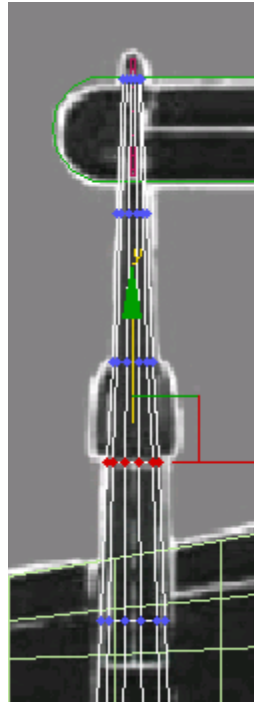

Select and move these red vertices up.

The vertices now line up in the top view, but need adjustment in the left view.

5. In the Left viewport, scale the selected vertices smaller along the Y axis, as necessary against the profile of the background image.

6.  In the Selection rollout, choose Polygon. This lets you select polygons instead of vertices.

7.  Make sure the Select Object button is turned on. In the Left viewport, drag a selection window over the polygons shown in the illustration below.

The selected polygon displays in red. If you don't see a fully shaded polygon, only surrounding edges, right-click the Left viewport label and choose Configure. In the

Rendering Options group, turn on Shade Selected Faces.

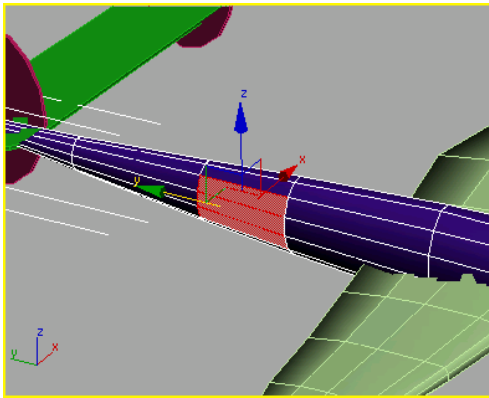

Dragging the selection window over these three polygons in the Left viewport also selects the three polygons on the opposite side of the sponson.

Note: It's important to have Select Object active here. If Select and Move were turned on, after making the first corner of your selection window, you'd start dragging the polygon around giving you undesired results.

8.  In the Edit Polygons rollout, click the Bevel Settings to open the Bevel Polygons dialog.
9. Set the Height setting to **0.152m**. Set the Outline Amount to **-0.095m**. Click OK.

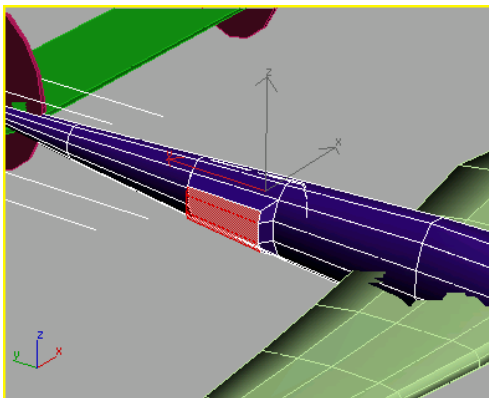



10.  Region Zoom around the exhaust gate in the Left viewport.

Because you have Lock Zoom/Pan turned on for the background image, you might see a dialog warning that some amount of memory is necessary to redisplay the background. Click Yes.

11. Once again, use a selection window to select the newly created polygons at the front of the exhaust gate, and then hold down the CTRL key and drag another selection window across the polygons at the rear.

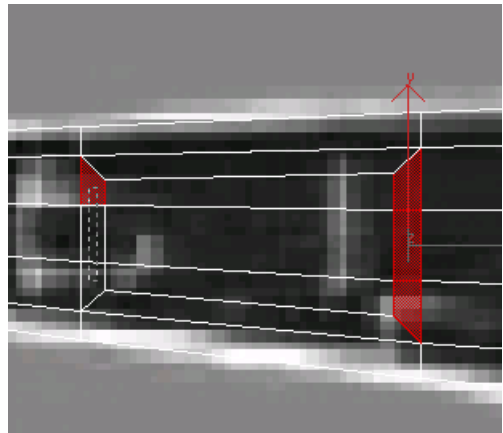
This will also select the polygons on the opposite side of the sponson.



12.  Click the Bevel Settings button and set the Height to **-0.1m** and the Outline Amount to **-0.025m**. Click OK.

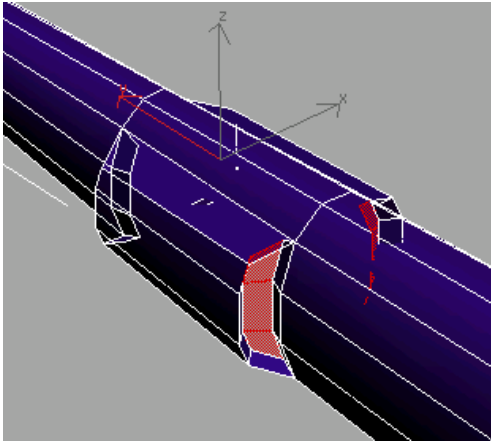

13. In the modifier stack, click Editable Poly to turn off sub-object selection.
14. Save your scene as **myp38_sponson3.max**.

Next, you'll clone the starboard sponson and spinner to make the port sponson and spinner.

Clone the sponson:

1. Select the sponson, if it isn't selected already.
2. Hold down the CTRL key and click the propeller spinner.

Now both objects are selected.



3. In the Top viewport, hold down the SHIFT key and move the selected objects to the right.

The Clone Options dialog appears.

4. Name the clone **port sponson** and click OK.
5. Select the new propeller spinner on the port side and rename it to **port spinner**.

Tip: Feel free to change the colors of all the objects so the plane looks more realistic.

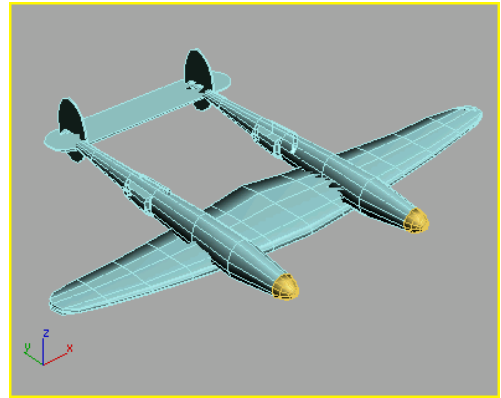

The P-38's wing, sponsons, and tail.

6. Save your work as **myp38_nogondola.max**.
All that remains is the central gondola and canopy detail.

Creating the Gondola

The plane is starting to look like a P-38, but it's missing the central gondola, the pilot cockpit. You will create the gondola using the same techniques you learned when you shaped the sponson. To ensure that the gondola is symmetrical, you'll use the Symmetry modifier.

Load a start file:

- Continue from the previous lesson, *Creating the Sponsons* (page 1–61), or you can load *p38_build_gondola.max* found in the `|tutorials|p38_lightning` folder.

Create the gondola:



1. Go to the Create panel, and on the Object Type rollout, click to turn on Cylinder. If you're continuing from the previous lesson, make sure AutoGrid is turned off.
2. In the Front viewport, drag out a cylinder over the gondola, until the radius approximately

matches the height of the gondola in the background image.

Watch in the Top viewport as you drag the height of the cylinder, since the Front viewport will not show any difference.

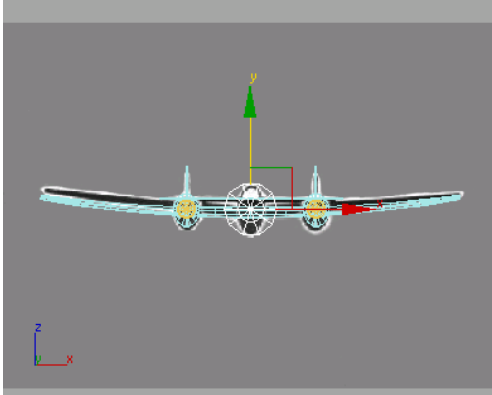

3. Edit the cylinder's parameters, as follows:

- Height Segments=9
- Cap Segments=2
- Sides=10

4. In the Name And Color rollout, name the object **gondola**.



5. If necessary, move the gondola object in the Top viewport so the top lines up with the trailing edge of the wing.

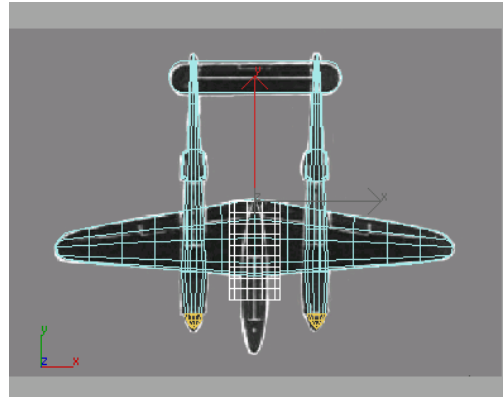

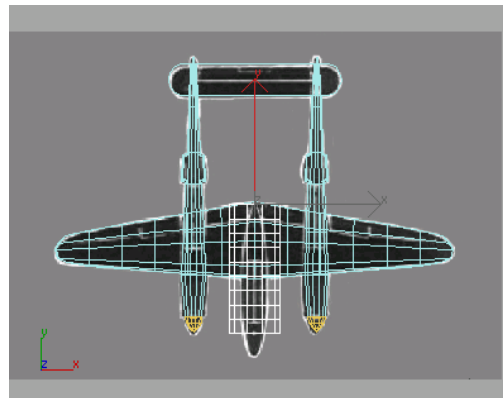

Line up the cylinder with the trailing edge of the wing.

6.  On the Modify panel, adjust the height of the cylinder so it is even with the end of the sponsons, as illustrated below.



Start with a cylinder.

Shape the gondola:

1.  Go to the Display panel, and hide everything but the gondola by clicking Hide Unselected in the Hide rollout.
2.  Go to the Modify panel. In the modifier stack, right-click Cylinder and choose Convert To: Editable Poly.

Now you can reposition the vertices over the background images.

3.  On the Selection rollout, click Vertex.
4. Starting at the rear of the gondola, in the Left viewport and do the following:
 - Select the leftmost column of vertices.
 - On the toolbar, choose Non-Uniform Scale from the Scale flyout.
 - Scale them to the approximate size to match the background image.
 - Move them down to match the background image as well. Alternate between scaling and moving as you work your way forward.

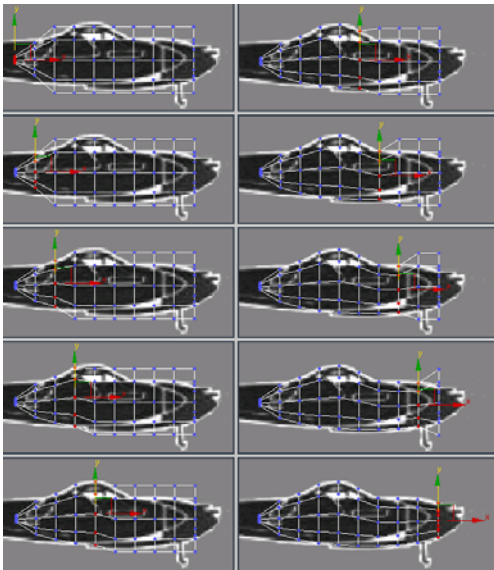

Scale and move the vertices to match the background.

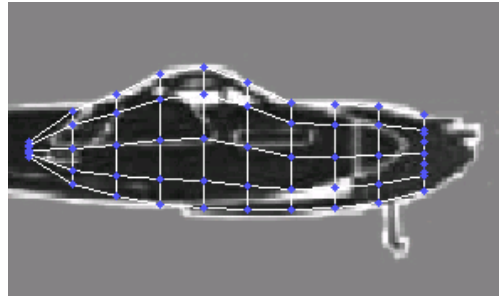

Placement of vertices from Left viewport.

5. With all that work done, save your scene as **myp38_gondola.max**.
6. Activate the Top viewport and repeat the previous process. Select one row of vertices at a time and position them over the background image using Scale and Move tools. Using the Transform gizmo, scale each row only along the X axis.

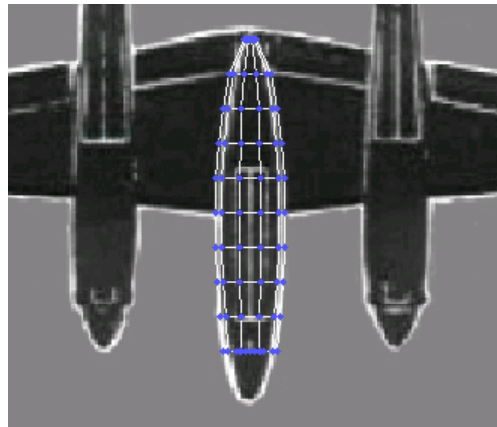

Vertex scaling and placement from the Top viewport.

7. In preparation of building the canopy, move and scale columns of vertices to match the outline of the cockpit in the Left viewport.

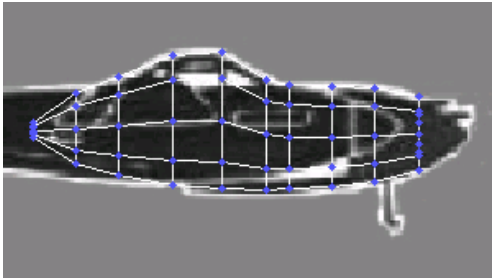

The 4th, 5th and 6th columns of vertices are moved and scaled.

8. Activate the Perspective viewport and start creating the nose by selecting the single vertex at the center of the cylinder cap. Then turn on Soft Selection and adjust the Falloff so the next ring of vertices turns yellow.

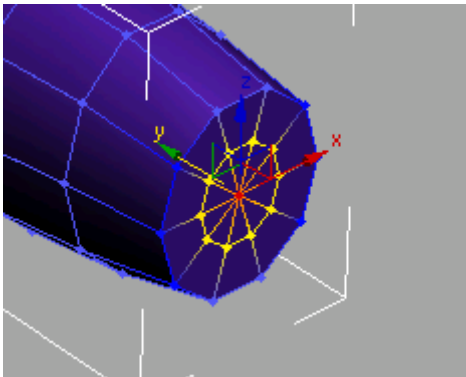

9. While watching the Left and Top viewports, move the soft selection forward to form the nose. Turn off Soft Selection, and move the single end vertex to create the point.

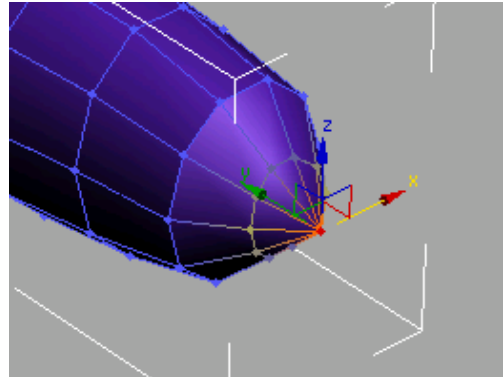

10. The nose might be a little too pointy, so from the Left and Top viewports, scale and move the second column of vertices to round the nose.

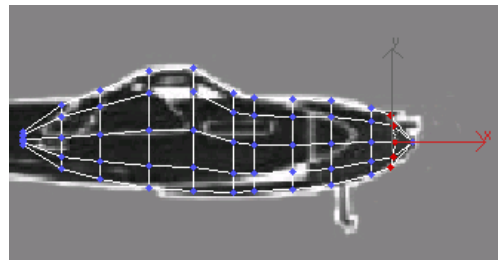

11. To unhide the rest of the airplane, on the Display panel, choose Unhide By Name. Select all the components you have created (everything except the calibration box).
12. Change the color of the gondola to match the rest of the plane.
13. Make adjustments as needed. Select the row of vertices at the rear of the gondola and move them along the Z axis in the Perspective viewport, so the rear taper is hidden in the wing.

You might also have to select the gondola and wing and move them up.

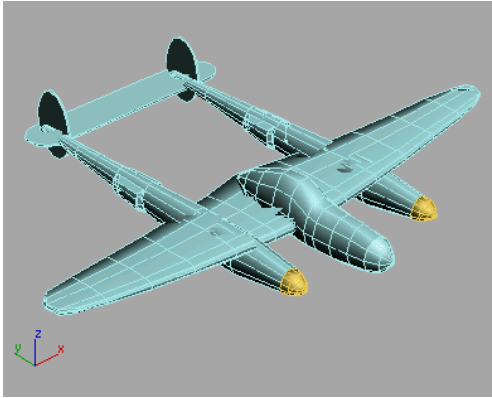

P-38 with gondola

14. Save your scene as **myp38_gondola2.max**.

You can create the canopy using a couple of editable poly tools. You'll cut and chamfer to create this detail of the cockpit.

Add the canopy:

1. In the Perspective viewport, select the gondola, if it's not already selected, and zoom in so you can see a close view of the cockpit area.
2.  On the Selection rollout, click Edge, then turn on Ignore Backfacing.
3. On the Edit Geometry rollout, turn on Cut.
4. Cut new edges into the cockpit. Click to set the beginning of an edge, then move the mouse to draw the new edge. Click again to set the end of the edge.

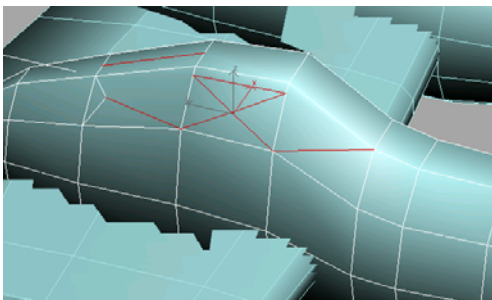

Cut these new red edges to form one side of the cockpit.

5.  Arc Rotate the view and make the same cuts on the other side of the cockpit.

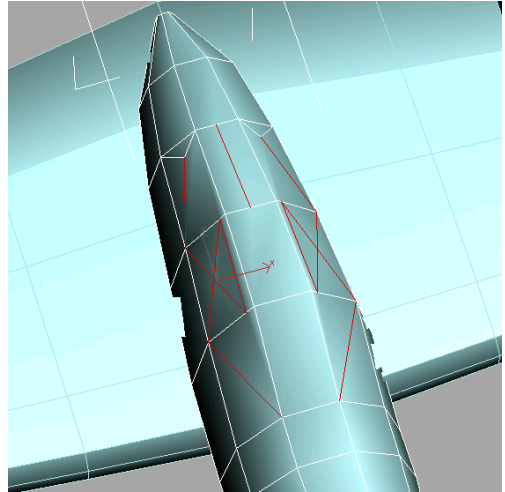

All these edges should be cut.

6. Click Cut again, to turn it off.
Now, you can chamfer edges to create the metal frame of the canopy.
7. In the Selection rollout, turn on Ignore Backfacing and select the edges around the cockpit, as illustrated below.

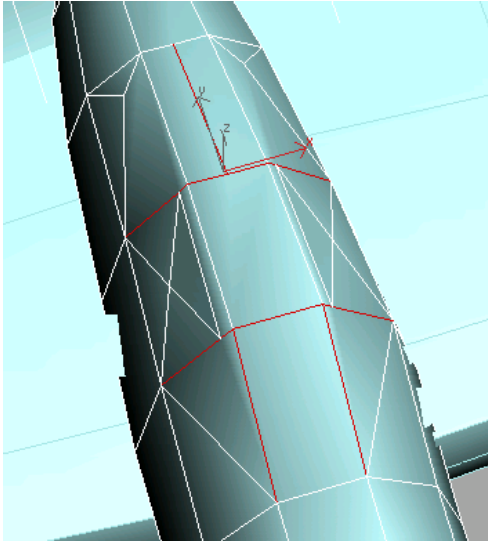

Select these red edges.

- In the Edit Edges rollout, turn on Chamfer. Move your cursor over one of the selected edges, click and drag up until it looks like the illustration below, and then release the mouse button.

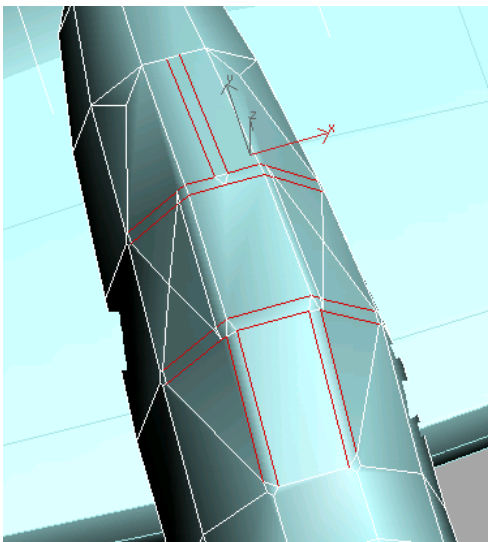

Chamfer edges to create the metal canopy frame.

- You can apply a transparent material to the canopy faces for extra detail. If you don't know how to create materials and apply them to polygons, see *Creating Multi/Sub-Object Materials* (page 1–136).

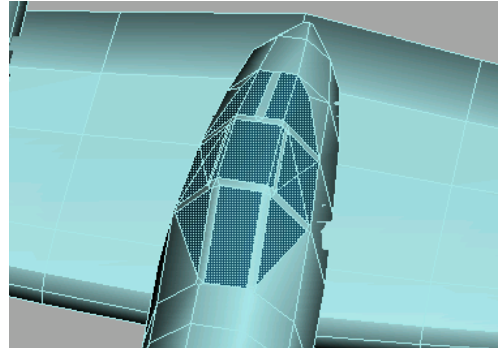

P-38 gondola with completed canopy.

- Save your work as **myp38.max**. Or you can open the completed file *p38_lightning.max* found in the `|tutorials|p38_lightning` folder.

Make sure the gondola is symmetrical:

The Symmetry modifier has been added to 3ds Max specifically for the purpose of building symmetrical models such as airplanes, boats and characters.

In the previous section, you cut a lot of edges to make up the canopy frame and glass. Some of those new edges may not be the same on either side of the gondola. Using the Symmetry modifier will ensure that the gondola is symmetrical.

You can continue from the previous section of open *p38_lightning.max*.

- Select the gondola object.
- In the Perspective viewport, right-click the gondola to open the quad menu and choose Isolate Selection.
-  Open the Modify panel and turn on Element mode and select the gondola.

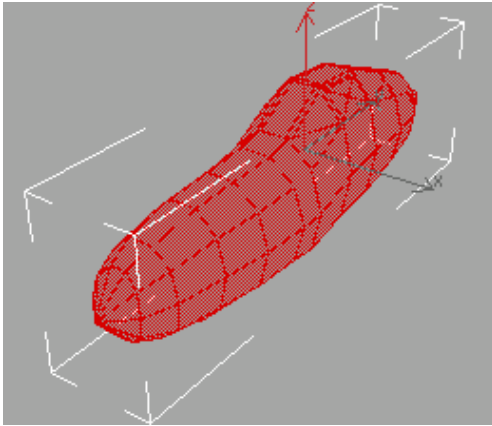

The selected element in red.

4. From the Edit Geometry rollout, click Slice Plane.

The gizmo appears, but it's not in the right orientation.



5. Click the Select and Rotate button from the toolbar and enter **90** in the Z coordinate field below the time bar.

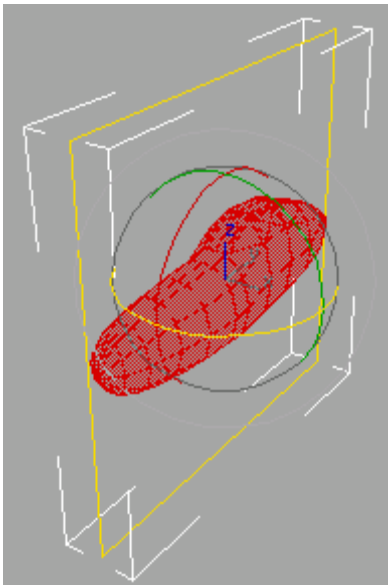

The slice gizmo is rotated correctly.



6. If necessary, move the gizmo left or right so it's centered on the gondola.

Tip: Zoom in the Top viewport to better adjust the gizmo position.

7. When the gizmo is positioned correctly, click the Slice button. Turn off Slice Plane.



8. Turn on Polygon mode and in the Top viewport drag a selection window around the right side of the gondola.



Tip: In the Selection rollout, make sure Ignore Backfacing is turned off and maximize the Top viewport when dragging the selection window.

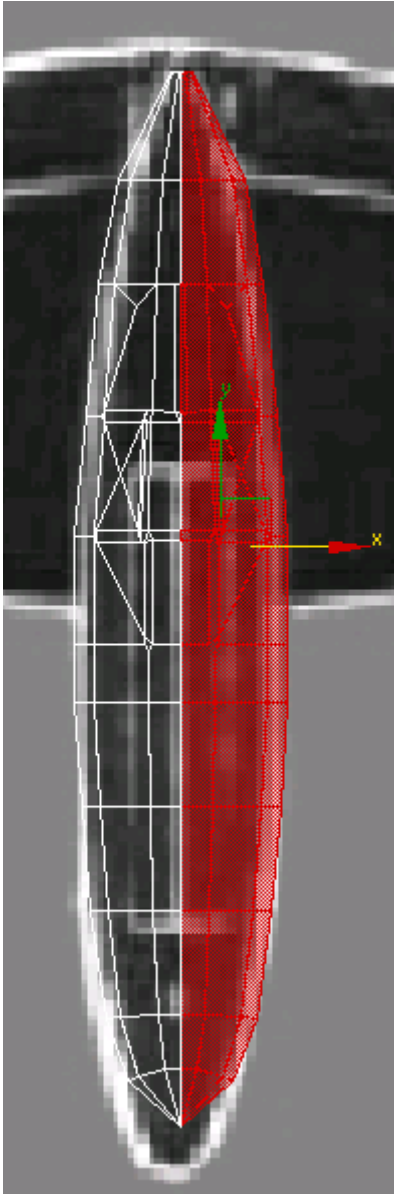

Half the gondola is selected.

9. Press the DELETE key and Yes when asked if you want to delete isolated vertices.

Note: You might have to zoom in on the rear end of the gondola to select some very small polygons and delete them as well.

10.  Turn off Polygon mode and choose Symmetry from the Modifier List.

The Mirror gizmo appears at the gondola's pivot point.

11. In the Parameters rollout, turn off Slice Along Mirror.

The new half is created and it is automatically welded.

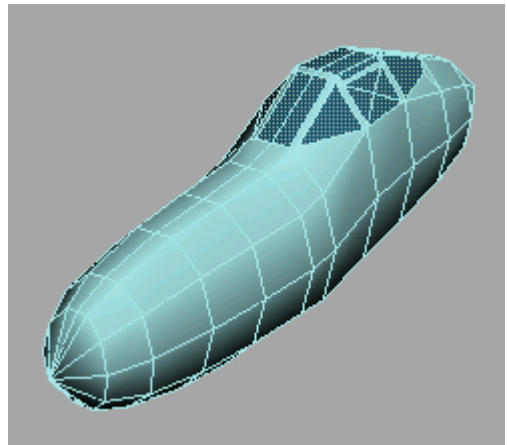

The whole gondola

12. Turn off Isolation Mode to view the rest of the model.
13. If you're working on your own P-38, there are many more details you could add, such as propellers, machine guns, and landing gear. Feel free to continue on your own. The *p38_lightning.max* has some detail added.

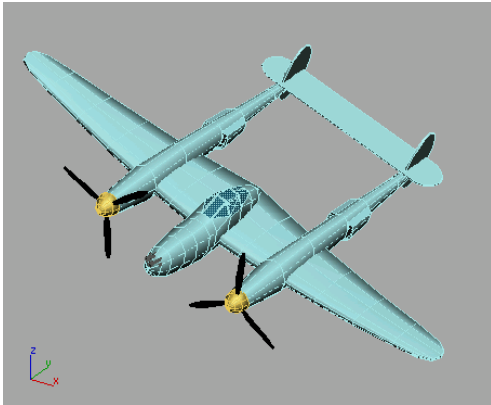

Propellers and machine guns added

Finishing the Plane

One major step remains: to link the plane into a single hierarchy. Before it's airworthy, however, you'll also need to rotate it into the proper orientation and adjust a pivot.

Load a start file

- Continue from the previous lesson, *Creating the Gondola* (page 1-68), or you can load *p38_lightning.max* found in the */tutorials/p38_lightning* folder.

To work properly with Microsoft Flight Simulator (FS), the pivot point of an aircraft used by FS as its center, should be midway between the propellers, and a quarter of the way back from the front of the wings. In this procedure, you'll make that adjustment in the Top viewport.

Adjust the gondola pivot

1. Activate the Top viewport and press **ALT+W** to maximize it.
2. Select the gondola object.



3. In the Command panel, click the Hierarchy tab. In the Adjust Pivot rollout, click **Affect Pivot Only**.

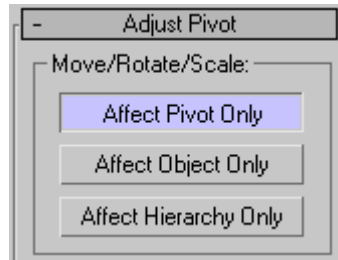

The gondola's pivot becomes visible, near its rear.

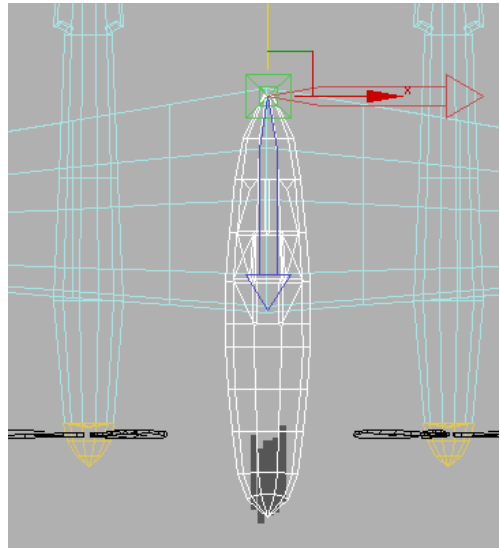

The gondola's pivot resembles the transform gizmo.

4.  Use **Select And Move** to move the pivot downward along its Y axis so that the pivot is about a quarter of the way back from the front of the wings.

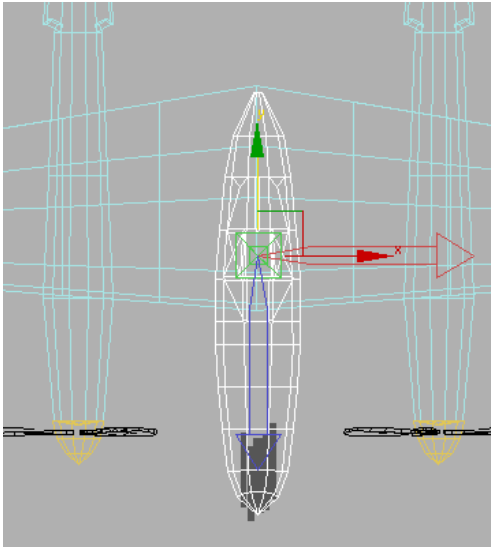

The gondola's pivot properly positioned.

5. In the Adjust Pivot rollout, click Affect Pivot Only again to turn it off.

Currently the plane looks like a single object, but it's really just a collection of unconnected parts. You can demonstrate this, if you like, by moving one of the parts, such as the gondola (if you do move it, be sure to undo before continuing). In this section, you'll connect all the parts into a hierarchy, so that moving the gondola moves the entire plane.

Build a hierarchy for the plane



1. Using the Select And Link tool, link the wing object to the gondola object. Click on the wing and drag the cursor over to the gondola, then release.
2. Next, link the two spanson objects to the wing object.
3. Continue linking until all objects belong to the same hierarchy, with the gondola as the topmost node. You can start in the Top viewport, but

you'll probably need to use the others as you go along.

How you link objects is up to you; the only firm rule is that the gondola must be above all the other objects in the hierarchy. As a rough guide, link small objects to larger nearby objects. For example, you might link the propeller objects to their related spinners, and then the spinners to their sponsons. This would create a three-level hierarchy, with the spanson at the top, the spinner as its child, and the propeller blades as the spinner's children and the spanson's grandchildren.

As you work, keep switching to Select And Move and move the gondola to see which objects come along with it. When you're finished, no objects should be left behind when you move the gondola.



You can also check the hierarchy by clicking the Select By Name button on the toolbar (or press the **H** key), and in the Select Objects dialog, turn on Display Sub-tree. This displays the hierarchy as a tiered list, with the parent object at the top.

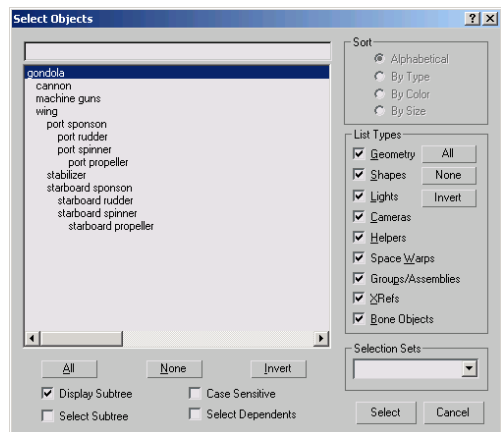

The final step is to rotate the plane so that it's pointing upward in the Top viewport. Otherwise you'll start out flying backward.

Turn the plane around

1. In the Top viewport, select the gondola.
2.  On the toolbar, click the Select And Rotate button.
3. On the status bar at the bottom of the screen, in the Coordinate Display area, enter **180** in the Z field.

When you press ENTER, the displayed value changes to -180.0, which is the same thing, rotation-wise.

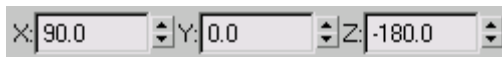

Also, the plane reverses its orientation in the Top viewport, facing upard.

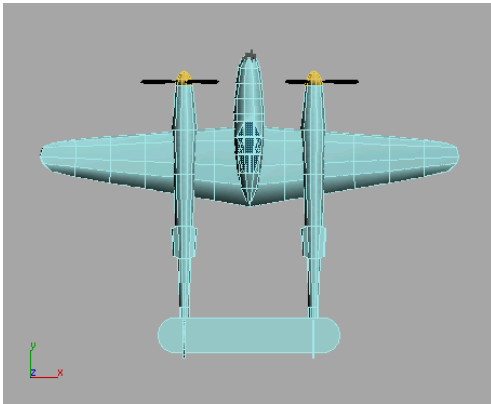

4. Save your work as **myp38.max**. Or you can open the completed file *p38_lightning_final.max*.

Summary

In this tutorial, you learned more about low-poly modeling using primitive objects like boxes, spheres and cylinders. You also made use of a background image to help in the modeling process.

Refining the Airplane

3ds Max has modeling features that can help you build models more efficiently. These lessons describe each feature and show you practical ways you can use them when constructing models.

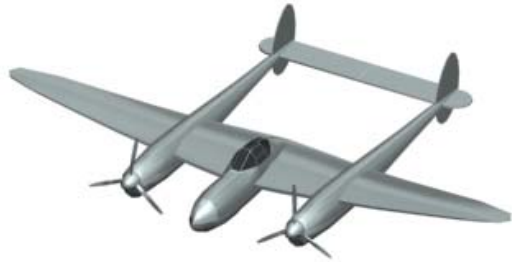

Skill level: Beginner to Intermediate

Time to complete: 2 hours (15 to 20 minutes per lesson)

Features Covered in This Tutorial

In these tutorials you will learn:

- Welding vertices with the Vertex Weld modifier.
- Features in Editable Poly.
- Ways to use soft selection.
- Features in the HSDS modifier.
- How to use the Edit Normal modifier.

Tutorial Files

All the necessary files to do the tutorials can be found on the Tutorial Files CD, the third CD that ships with 3ds Max. Before starting any tutorials, copy the *tutorials* folder from the CD to your *3dsmax8* local installation.

The files for the lessons in this tutorial are in the *tutorials\p38_lightning* folder.

Using the Vertex Weld Modifier

In this lesson, you'll work on a model that was built with an older version of 3ds Max. It's a low-poly model of an airplane that was created using the Mirror tool.

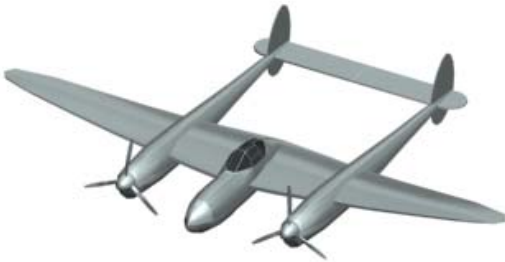

Low-poly airplane

Set up the lesson:

Files for this lesson are in the *tutorials\p38_lightning* folder.

- Load the *low_poly_p38.max* file. This scene includes an airplane named *Lightning*.

Weld the seam between the two halves:

Since this model was built prior to 3ds Max 8 using the Mirror tool, there is a seam of unwelded vertices where the two halves of the plane meet.

1. In the Front viewport, select the airplane, *Lightning*.
2.  Use Region Zoom to center the view on the cockpit section of the airplane.

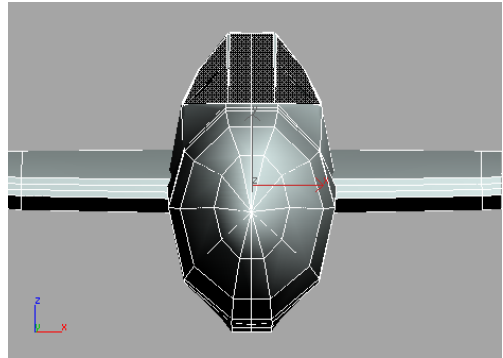

3. Choose Modifiers menu > Mesh Editing > Vertex Weld.

You can also apply the Vertex Weld modifier from the Modify panel > modifier list > Object-Space Modifiers > Vertex Weld.

4. In the Parameters rollout, set the Threshold to **.75"**.

This is one way to clean up the model.

Note: Be careful not to set the Threshold too high. If you do, the model will begin to degrade as more vertices get welded together.

5. Experiment a little by setting the Threshold to **1'**, **6"**, and **3"**.

While the Vertex Weld can be used to reduce the number of faces a model has, greater values distort the model drastically.

6. Set the Threshold back to **.75"** and save the scene as **welded_lightning.max**.

Using the Editable Poly Tools

3ds Max has a set of handy editable poly tools that improve the way you can clean up and add detail to your models.

This set of lessons focuses on several tools.

Set up the lesson:

- Open *low_poly_p38_02.max* from the *tutorials\p38_lightning* folder.



Detail the air intakes:

The first detail you'll add are the air intakes on the *sponsons* of your Lightning. The sponson is the long extension between the wings and the tail section of the airplane.

1.  In the Right viewport, Zoom Region around the sponson between the wing and tail.

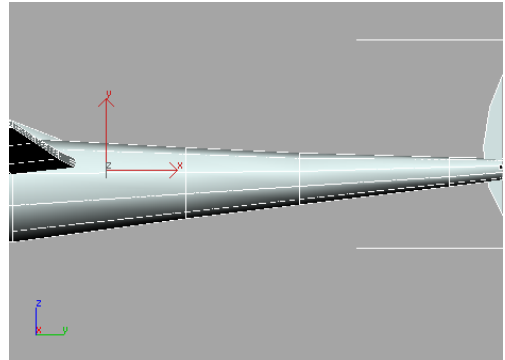

2. Select the object, *Lightning*.



3. Go to the Modify panel and click the Editable Poly entry in the modifier stack.

Note: Half of the airplane disappears because you've chosen to work at a lower level in the modifier stack.



4. Click the Show End Result On/Off Toggle button that is located along the bottom of the modifier stack.

Turning on this toggle lets you see the results of additional modifiers all way up the modifier stack. You now see the other half of the airplane generated by the Symmetry modifier that was used in the sample file you opened for this lesson.



5. From the Selection rollout, click the Polygon button and make sure Ignore Backfacing is turned off.



6. Turn on Select Object and drag a window across the three polygons in the center of the sponson. Make sure the polygons at the top and bottom are not selected.

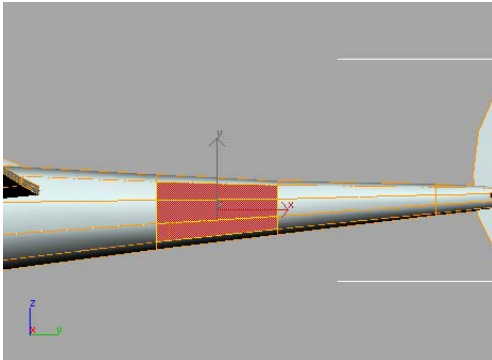

Tip: Press **F2** on the keyboard to see selected polygons displayed in red.

7.  In the Edit Polygons rollout, click the Settings button next to the Bevel tool.

The Bevel Polygon dialog appears.

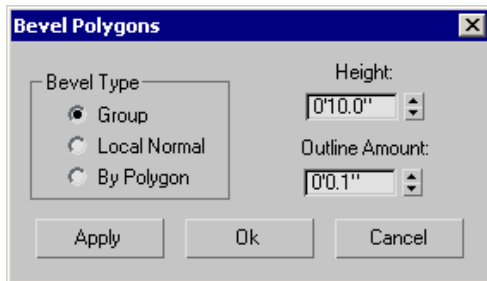

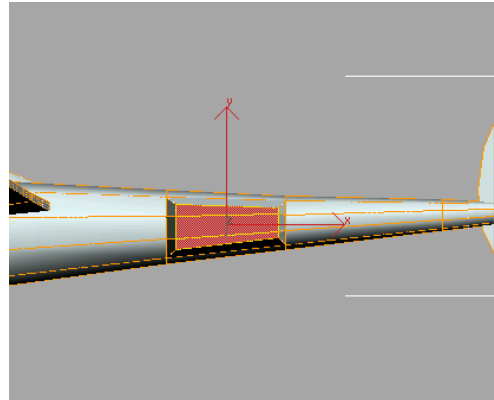

8. Set the Height to **7"** and the Outline Amount to **-3.5"**. Click OK.

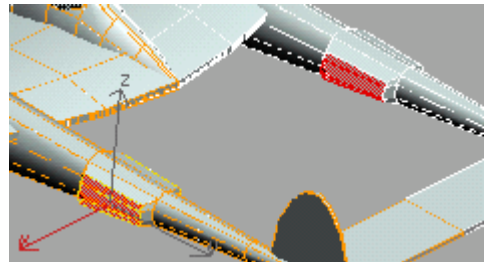

The air intake starts to take form.

Because the Symmetry modifier was used, any change you make to the original half of the airplane is automatically reflected in the mirrored half.



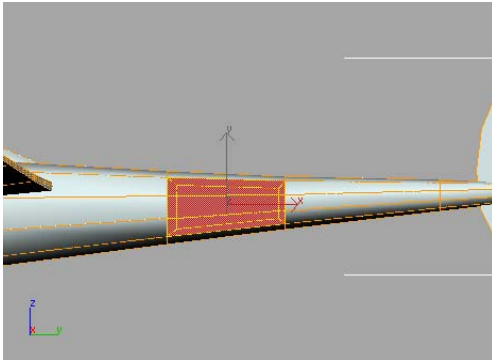

9.  Make sure Select Object is active, and then click the Grow button in the Selection rollout.

Grow increases the polygon selection to include polygons that share a common edge.

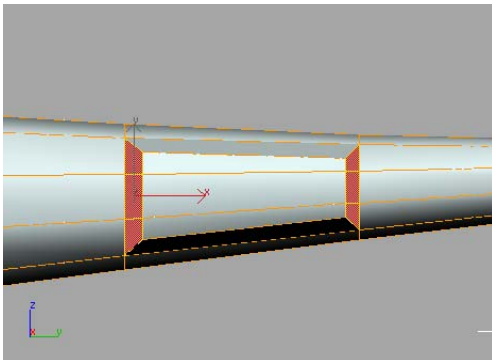

10. While holding down the **ALT** key, drag a window across the middle set of polygons to deselect them. Select only the polygons on the left and right, as viewed in the Left viewport.



11.  Click the Settings button next to the Inset tool in the Edit Polygons rollout.

The Inset Polygon dialog appears.

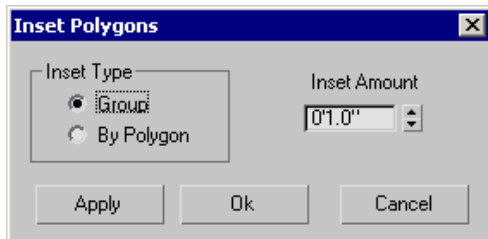

12. Set the Inset Amount to **1.5"** and click OK.

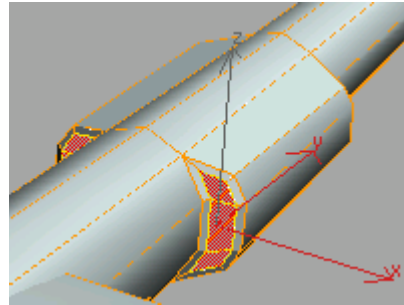

Inset creates new polygons from the current selection by offsetting their edges toward the inside.

13.  Click the Settings button next to the Extrude tool in the Edit Polygons rollout.

The Extrude Polygon dialog appears.

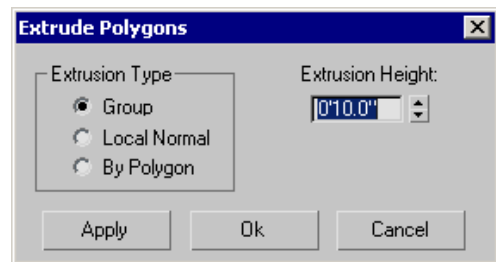

14. Set the Extrusion Height to **-5"** and click OK.

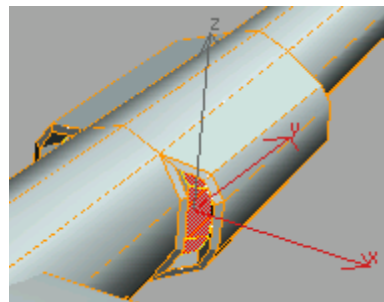

The air intakes are now complete. Next, you'll build some engine exhaust ports.



15. Save your scene as **mylightning02**.

Add engine exhaust ports:

Next, you'll add exhaust ports to either side of the forward section of the sponson near the propellers. Continue with the model you saved during the previous exercise, or open *low_poly_p38_03.max*. If you load this file, select the airplane, go to the Modify panel, and access the Polygon sub-object level of Editable Poly.

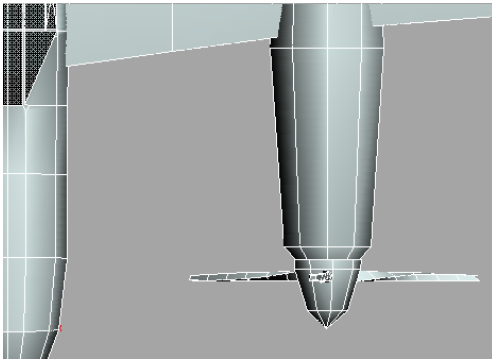
1.  In the Top viewport, use Region Zoom to zoom into the right-side engine/propeller section.



2.  Make sure the Show End Result On/Off Toggle button at the bottom of the modifier stack is turned on.
3.  Turn on Select Object and select the polygons at the left and right sides of the engine housing. If selected polygons do not appear in red, press the **F2** key on the keyboard.

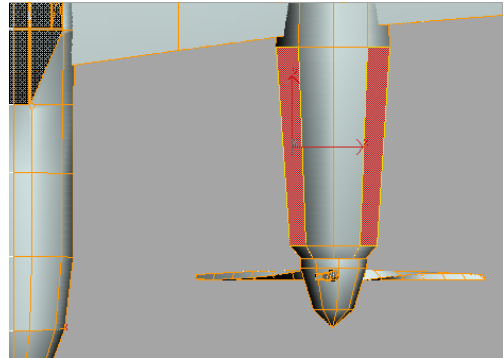

4.  Activate the Right viewport and use Region Zoom to center the view around the engine section. If necessary, deselect polygons until only the topmost polygons on the engine housing are selected. Press **F2** to display selected polygons in red.

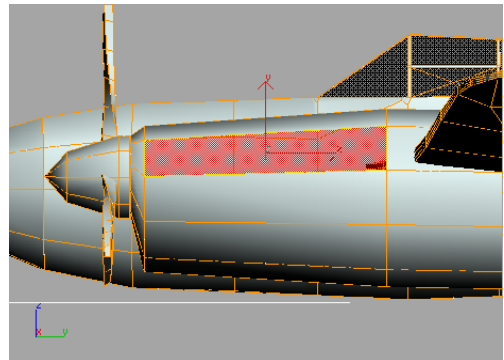

5.  Click the Settings button next to the Inset tool in the Edit Polygons rollout.

The Inset Polygon dialog appears.

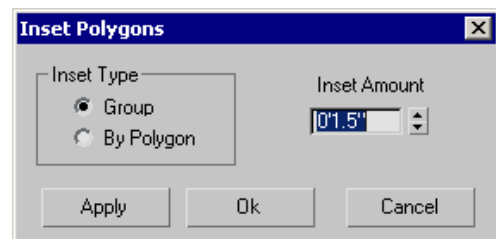

6. Set the Inset Amount to 3.5" and click OK.

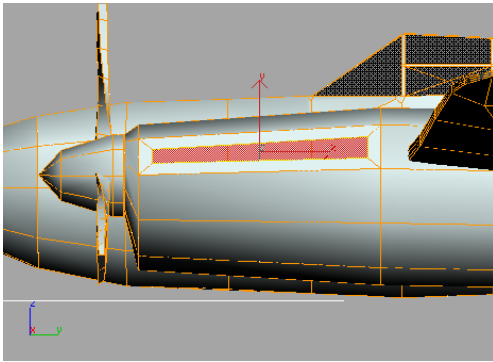

7. In the Top viewport, select only the inside polygon.

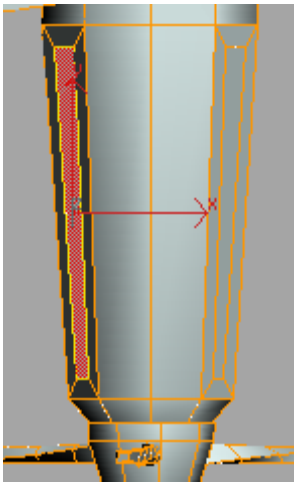

8.  Click the Settings button next to the Hinge From Edge tool in the Edit Polygons rollout.

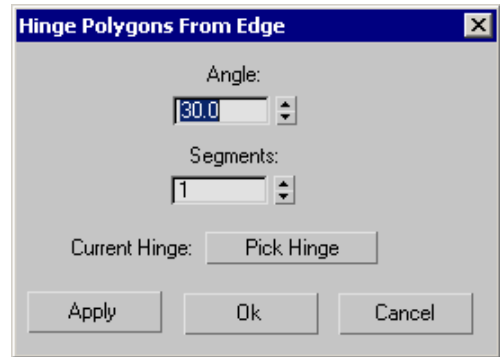

9. Click the Pick Hinge button. In the Top viewport, select the left edge of the selected polygon.

The button text will change to *Edge 1051*. This will cause a hinged face to be created at this edge.

10. Set the Angle value to 45 and click OK. The hinged face is created.

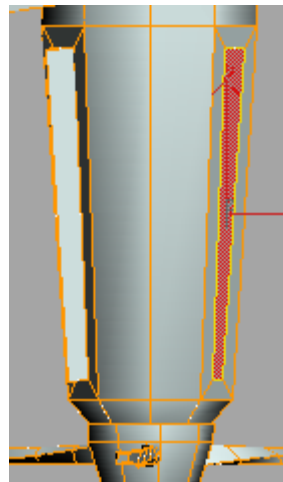

11. Select the outside polygon.
 12. Repeat the Hinge procedure using the right edge, *Edge 1057*, as the hinge.
 13. Save your scene as **mylightning03.max**.

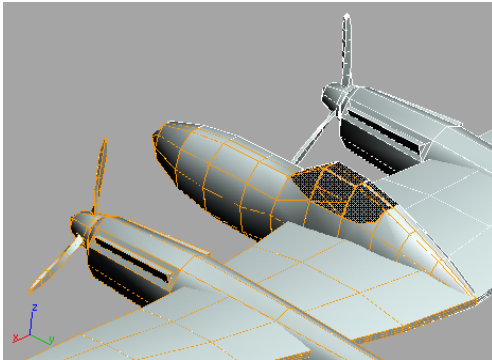

View of the engine exhaust ports you've added

Using Soft Selection



The original propellers on this model are a little too clunky-looking. In this lesson, you'll remove the existing propeller blades and replace them with new blades.

Set up the lesson:

- Open *low_poly_p38_04.max*.

Change the propellers:

1.  In the Front viewport, use Zoom Region to center the view around the port engine of the airplane.

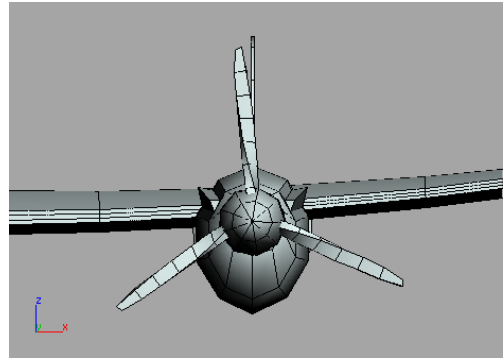

2. Select the *Lightning*.



3.  Go to the Modify panel and pick the Editable Poly entry in the modifier stack.



4.  Click the Show End Result On/Off Toggle button that is located along the bottom of the modifier stack.



5.  From the Selection rollout, turn on the Element button and make sure Ignore Backfacing is turned on.

6. While holding down the CTRL key, select each of the propeller blades.

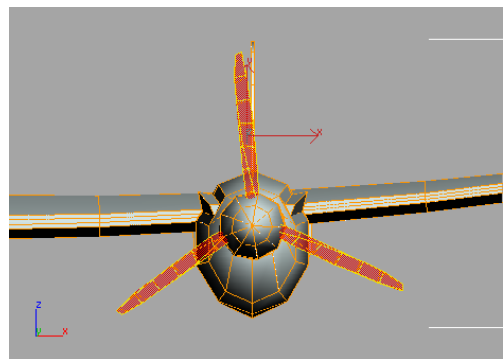

7. Click the Detach button from the Edit Geometry rollout and click OK at the Detach dialog.

Note: When you detach the propellers, notice that they disappear from the opposite side of the airplane. This is because they are no longer part of the editable poly that has a Symmetry modifier applied to it.

8. Click the Editable Poly entry in the modifier stack to turn off the sub-object mode and pick the propellers.
9. Press the DELETE key to remove the propellers you just detached.

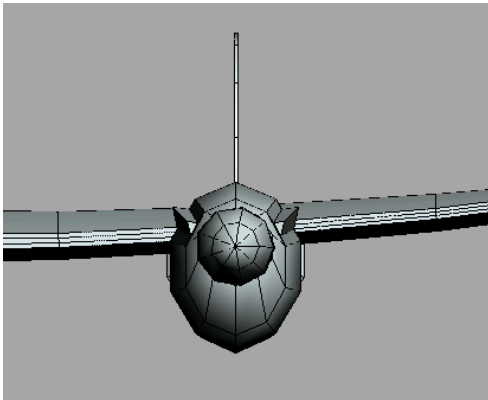

The Lightning has no propellers now.

Add the new propeller blades:

You'll use the Merge command to add a new propeller blade to your model.

1. Choose File menu > Merge.
The Merge File dialog appears.
2. Browse to the `|tutorials|p38_lightning` folder and double-click the file `newprops.max`.
The Merge – newprops.max dialog appears.
3. Select the `Blade01` object and click OK.

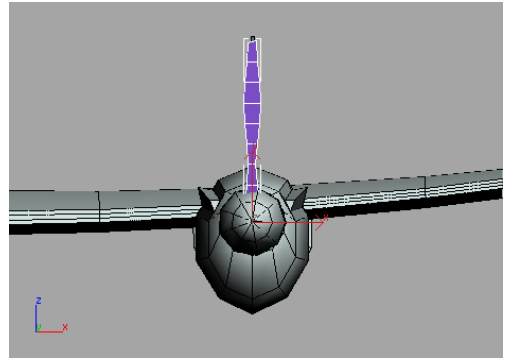

The new propeller blade appears in your scene.



4. Activate the Front viewport and turn on the Select And Rotate button.
5. While holding down the SHIFT key, rotate around the Z-axis to approximately **120** degrees.

The Clone Options dialog appears when you release the mouse button.

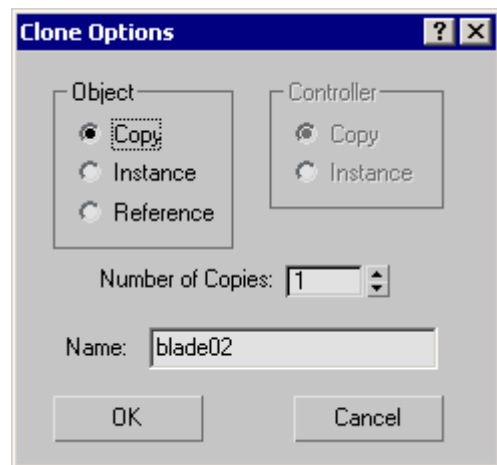

6. Set the Number Of Copies to **2** and turn on Instance in the Object group. Click OK.

Note: Turning on Instance is very important, as you'll soon see.

Add a final touch for realistic propeller blades

Now that the new blades are in the scene, you'll want to twist the blades to make them look realistic. You'll use a Soft Selection to accomplish this.

Twist the blades:

1.  Turn on Select Object. In the Front viewport, select the top propeller blade.

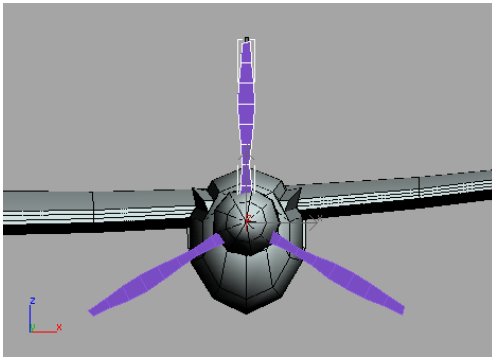

2.  On the Modify panel, click the Vertex button in the Selection rollout.
3. Drag a window around the top set of vertices at the tip of the propeller blade.

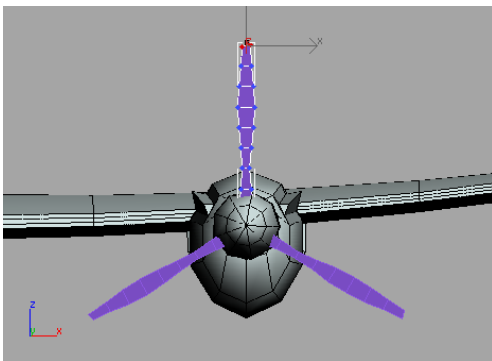

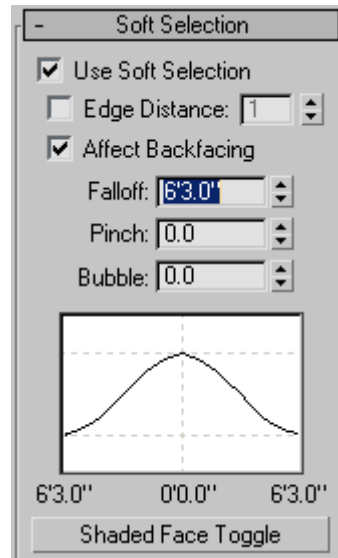

4. Open the Soft Selection rollout and turn on Use Soft Selection.

5. Drag or set the Falloff setting to 6'3".

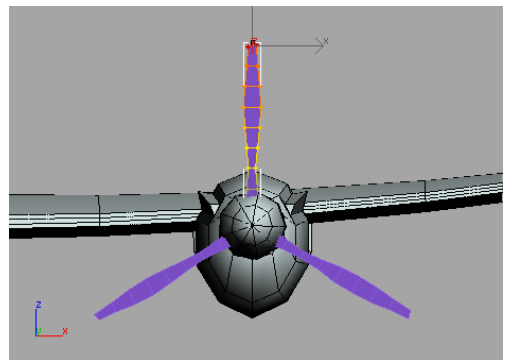

Notice what happens to the adjacent vertices as you increase the falloff. Vertices closest to the top will be affected more than the vertices that are further away.



6.  Turn on the Select And Rotate button and rotate the selected vertices around the Y-axis to -35 degrees.

Because the second and third blade are instances of the first, any change you make to the first blade affects the other two.

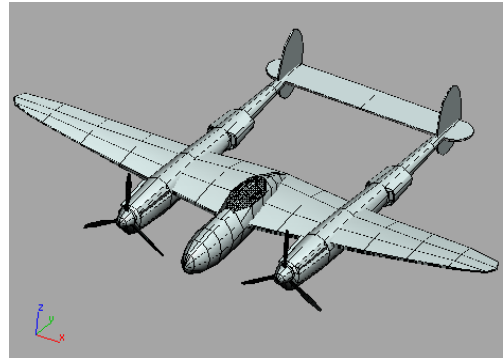
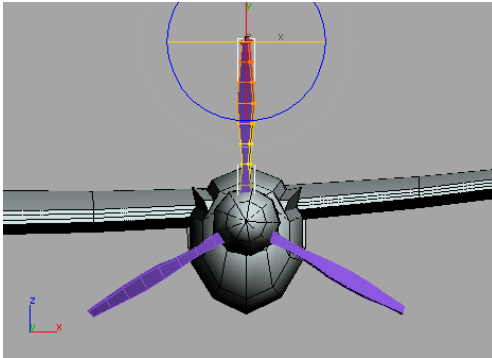

- Click the Vertex button in the Selection rollout to turn off the Vertex sub-object mode.



- Turn on Select Object and select the *Lightning*.



- Select the Editable Poly entry in the modifier stack and click the Attach List button, next to the Attach tool, in the Edit Geometry rollout.

The Attach List dialog opens showing you the three propeller blades.

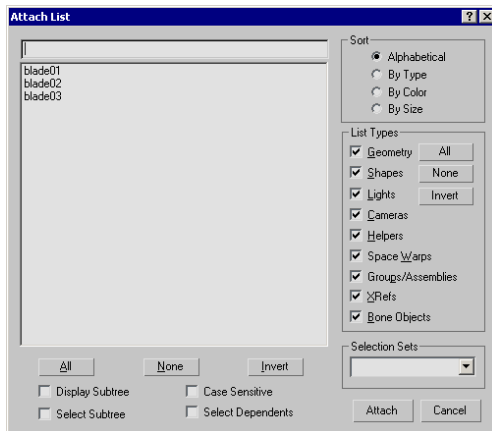

- Click the All button at the lower left and then the Attach button.

The blades are now attached to the rest of the airplane, and they are automatically added to the opposite half due to the Symmetry modifier.

- Save your scene as **mylightning04.max**.

Using the HSDS Modifier

The HSDS (Hierarchical SubDivision Surface) modifier is a finishing tool rather than a modeling tool. It gives you the best result when working on low-polygon models, like the P-38 Lightning.

This lesson will give you a better understanding of HSDS modifier's use. You'll use the modifier on the tail of the airplane to give it a couple of levels of detail.

Set up the lesson:

- Continue with the model you saved during the previous exercise, or open *low_poly_p38_05.max* in the *tutorials\p38_lightning* folder.

Refine the rudder:

1.  In the Right viewport, use Zoom Region to center the view around the rudder of the airplane.

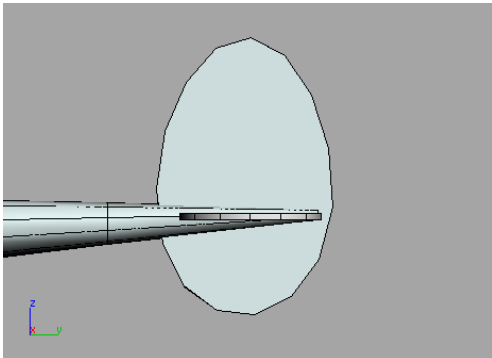

2. Select the *Lightning*.

3.  Go to the Modify panel and pick the Editable Poly entry in the Modifier stack.

4.  Click the Show End Result On/Off Toggle button that is located along the bottom of the modifier stack.

5. From the Modifiers menu, choose Subdivision Surfaces > HSDS Modifier

6.  From the HSDS Parameters rollout, turn on the Element button.

You'll see half of the airplane displayed in a yellow mesh.

7. Select the rudder element.

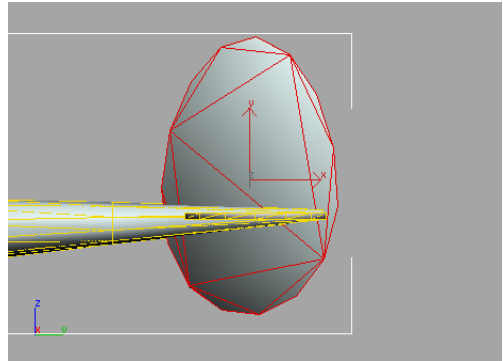

8. Click the Subdivide button under the level-of-detail display.

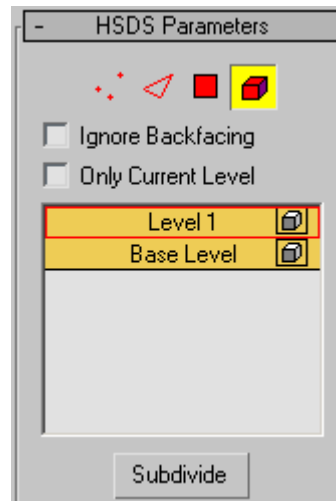

The rudder becomes more refined and the edges are much smoother. A level of detail, Level 1 is added to the level of detail list.

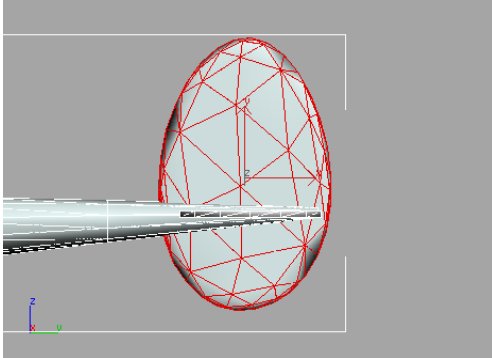

HSDS allows you to increase the mesh resolution of specific parts of the model instead of the entire model

9.  On the HSDS Parameters rollout, turn on the Polygon button, then drag a selection window over the rear polygons on the rudder.

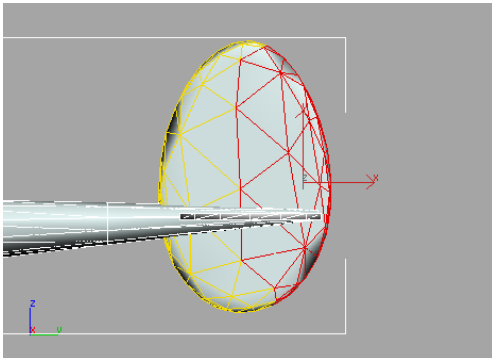

10. Click the Subdivide button again.

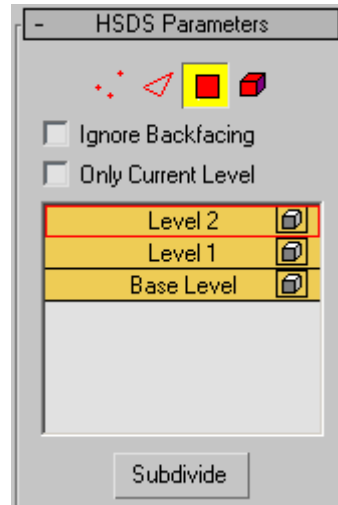

A second level of detail is added to the level of detail list and the rear part of the rudder is even more refined.

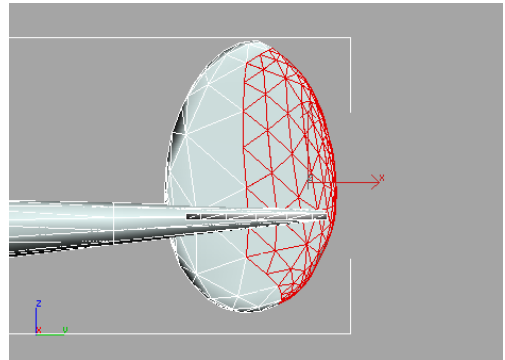

11. Click the display button next to the Base Level.
Level 1 and 2 are turned off and you see the original polygons you started with.

Using the Edit Normal Modifier

The Edit Normal modifier in 3ds Max was developed with game developers in mind. Now that many game engines and graphics hardware use pixel and vertex shaders, demand has increased to give modelers the ability to adjust normals

interactively when looking at the result of a pixel vertex shader.

Note: In order to see the results of using the Edit Normal modifier, 3ds Max should be configured for DirectX.

Set up the lesson:

- Continue with the model you saved during the previous exercise or open *low_poly_p38_06.max* in the *tutorials\p38_lightning* folder.

If you use the sample scene, some of the plane's components have been hidden for better performance. It's also been maximized to the Perspective viewport.

Adjust the normals on the wing:

1. Select the *Lightning*.



2. Open the Modify panel and unroll the Modifier List.
3. Click Edit Normals.

The normals are indicated by the blue lines that suddenly sprout from the model. The dark blue color tells you the normals are Unspecified and are calculated based on the smoothing groups of surrounding faces.

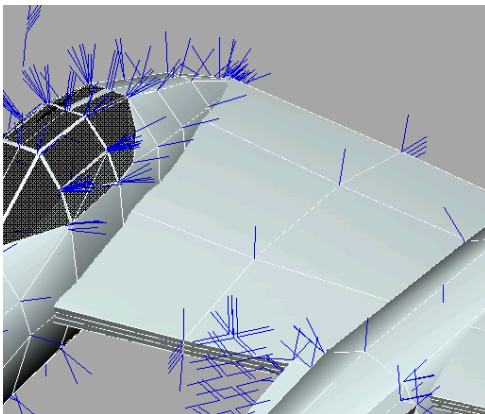

4. Select Normal 194.

This normal is in the middle of the wing between the cockpit and sponson.

You can also see which normal you've picked by looking at the display at the bottom of the Parameters rollout.

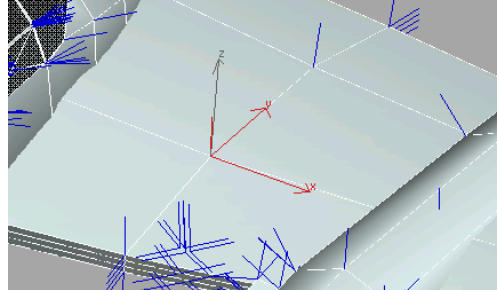

5. Rotate the normal. Notice the effect different rotations have on the surface of the airplane.

The surrounding surfaces get lighter or darker depending on how you rotate the normal.

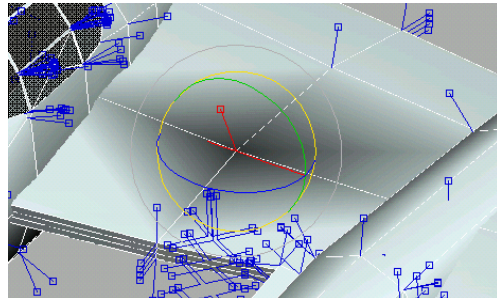

Note: Once you make a manual change to the original orientation of the normal, the normal changes to a green color, signifying that it's now an Explicit normal.

6. Experiment by selecting some of the other normals, or try working with groups of normals to see how they respond.

Summary

You have learned about several powerful features that will improve your modeling skills. The Editable Poly object is very versatile, and works with many modifiers to help you shape an object exactly as you like.

Modeling a Head with NURBS

In this tutorial, you use NURBS to create the head of a 3D cartoon character. NURBS can be especially suited for modeling organic, free-form surfaces such as this character.

Note: NURBS are good for modeling free-form surfaces, but they are computationally expensive. If you want to do character animation, an editable mesh or editable patch model is the better choice. Meshes and patches require less computation, and animate more quickly and reliably.

The concept for our cartoon character began with an artist's pencil sketch.

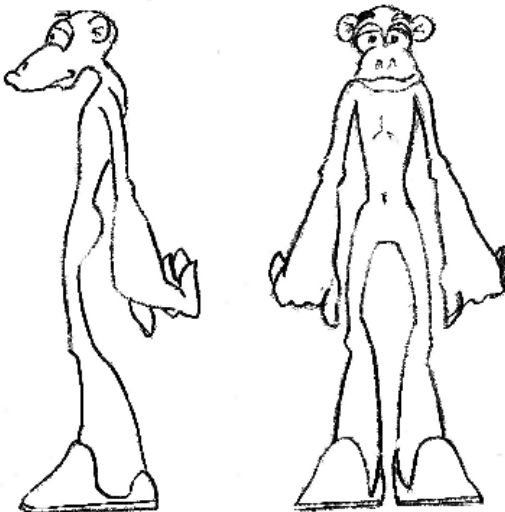

Another artist then used this sketch to create the rounded, animatable figure known as Goco the Monkey Boy.



This tutorial doesn't guide you through creating the entire figure, or animating it. It concentrates on creating the character's head. Creating the head demonstrates a variety of techniques for NURBS modeling in 3ds Max.

Skill Level: Intermediate

Time to complete: 60 minutes

Features Covered in this Tutorial

- Using a background image to trace NURBS curves
- Drawing CV Curves
- Creating a loft surface from CV Curves
- Using CV Curve on Surface to add details to a lofted NURBS surface
- Mirroring and welding a lofted NURBS surface
- Attaching lofted surfaces to one another

Tutorial Files

All the necessary files to do the tutorials can be found on the Tutorial Files CD, in the `ltutorials\nurbs_modeling` folder. Before starting any tutorials, copy the `ltutorials` folder from the CD to your `!3dsmax8` local installation.

Creating Contours for the Head

The head is the most complicated part of the model, and the most critical for showing the character's personality. The overall technique is to use contour curves to model half the head. This preserves symmetry and also saves computation time. The contour curves become the basis for a U loft surface. When half the head is finished, you mirror the half and make the head complete.

In this lesson, you use scans of the artist's sketch as viewport backgrounds to help you make the contour curves.

Set up the scene:

1. Start 3ds Max.
2. Choose Customize > Units Setup.
3. In the Units Setup dialog, choose US Standard. Make sure Feet w/Decimal Inches is active, and then click OK.

It's easiest when you work to scale. Goco will be about six feet tall, and the head will be about 18 inches from front to back.

Set up the background:

1. Right-click the label of the Left viewport, and under Views choose Right.
 2. Make the Right viewport active, and then choose Views menu > Viewport Background.
- Note: You can also press **ALT+B**.
3. In the Viewport Background dialog, click Files and choose *head_side.png* as the background source.

Note: Files for this tutorial are in the *|tutorials|nurbs_modeling* directory.

4. Turn on Match Bitmap and Lock Zoom/Pan, then click OK.

Tip: Whenever you need to adjust the position of the background relative to the model, use

CTRL+ALT+B to toggle Lock Zoom/Pan.

When Lock Zoom/Pan is off, the model zooms and pans independently of the background.

When Lock Zoom/Pan is on, zoom and pan affect both the model and the background.

Tip: Another way to view reference images while you model in 3ds Max is to display them using the Asset Manager.

5. Right-click the Right viewport label and turn off Show Grid.

Tip: You can also press **G** to toggle the grid display in viewports.



Now you're ready to begin creating the model.

Initialize the first contour curve:

1. In the Front viewport, create a Circle shape with a radius of 6 inches.

The circle is a general starting-point for creating contours.

2. Right-click the circle. In the Transform (lower-right) quadrant of the quad menu, choose Convert To: > Convert to NURBS.

Now you can use NURBS features to adjust the contours. As you will see, a NURBS model consists of one or more sub-objects. NURBS sub-objects include curves and surfaces.

To make sure the head is symmetrical, at first you model only half of it. The first step for the first contour is to make it a semicircle.



3. Go to the Modify panel.



4. On the modifier stack display area at the top of the Modify panel, click the plus icon to the left of NURBS Surface. This expands the hierarchy of the NURBS object. Choose Curve as the sub-object level.



5. Click Curve to select it.
6. On the Curve Common rollout, turn on Break, then click the circle at the top and bottom (12 o'clock and 6 o'clock).

Now you have two semicircular curves.

7. Right-click in the viewport to turn off Break. Click the left-hand curve to select it, and then on the Curve Common rollout, click Delete.
8. Click the remaining, right-hand curve to select it, and then click Convert Curve.
9. In the Convert Curve dialog's CV Curve tab, choose Number and reduce the number of CVs on the curve to 10.

CVs are "control vertices." They control the shape of a NURBS CV curve. Reducing the number of CVs makes the curve more efficient and easier to handle. In general, when you work with NURBS try to use the minimum detail necessary.

10. Click OK to close the Convert Curve dialog.
11. In the Modify panel > Modifier Stack, click the top level to exit sub-object mode.

Start forming the contour curves:

You start by creating contours for the profile. Later you will load a scan of Goco's full face, and adjust the contours to match.

1.  Right-click in the Right viewport to activate it, then click Min/Max Toggle to see only the right view.

2.  Rotate, move, and uniformly scale the contour so it sits at the base of Goco's snout, as seen in the following illustration.



Note: Avoid using non-uniform scale with NURBS models and their sub-objects.

3. On the modifier stack display, change the sub-object selection level to Curve CV.

4.  Move CVs in the curve so the curve more closely follows the contour of the snout, from the right view.



Tip: Often it is easiest to move the CVs in order, from top to bottom or bottom to top. Also, when CVs are close together, the transform gizmo can get in the way of selecting a new one, so you might have to click and move a CV, click to deselect it, click to select the new one, and so on. (On the other hand, the transform gizmo can be useful when you adjust overlaying curves; for example, when you adjust contours to match the full-face sketch of Goco.)

5. Right-click the NURBS model. In the Tools 1 (upper-left) quadrant of the quad menu, choose Sub-objects > Curve.

When you modify NURBS models, the quad menu has shortcuts for changing the sub-object level, and performing some other Modify panel commands.

From this point, the steps will say simply "go to a sub-object level." You can use either the quad menu or the stack display to do so.

6. SHIFT-move the curve to create a copy of it toward the back of the head. In the Sub-Object Clone Options dialog, leave Independent Copy chosen as the method, and then click OK.
7. Return to the Curve CV sub-object level, and again adjust the CVs so the curve follows the head.



Contour the back of the head and the neck:

The contour curves are closer together at the base of the neck, farther apart at the top of the head.

- Continue to clone a contour at the Curve level, then adjust its CVs at the Curve CV level, until in addition to the original contour you have five contours for the top and back of the head, going to the base of the neck, as in the following illustration.

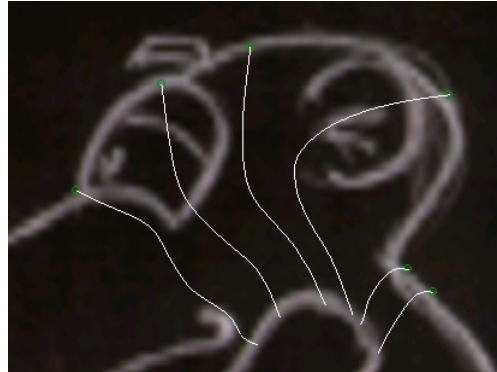

Tip: When you get to the neck, it can be helpful to zoom in because the CVs are closer together.

Contour the snout and the mouth:

The important thing about modeling the snout is that contours should surround the mouth but never cross it. This way, you will be able to animate the mouth later.

1. SHIFT-clone the original contour curve, this time in the direction of the nose.
2. Adjust the new contour's CVs, being careful not to cross over the mouth. "Pinch" the curve somewhat at the corner of the mouth, placing two or three CVs near each other there.

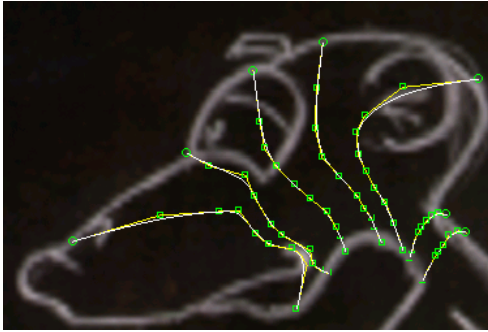

When two or three CVs are near each other, a CV curve grows sharper.

3. Create another contour curve. Don't move it much, but move its CVs to project farther along the snout.

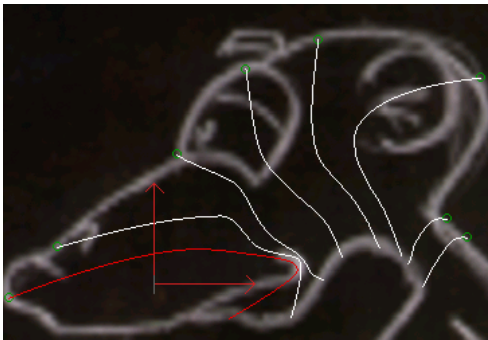

Tip:  When two CV curves are close to each other, it can be hard to tell which curve a CV belongs to. Turn on the Keyboard Shortcut Override Toggle button, and then select a CV on the curve you want. Now you can hold down CTRL while you use the arrow keys. This moves among the CVs on the active curve, with no danger of selecting one from a different curve.

Another tip:  Lock Selection is also useful when you are moving CVs. CTRL+arrow works even while Lock Selection is on, so you can move multiple CVs without worrying

about changing the selection by clicking the wrong CV.

Tip: SPACEBAR toggles the Lock Selection Set button on and off.

4. Create two more contours, creating four in all for the snout, not counting the original contour. The last contour follows the shape of the mouth itself.

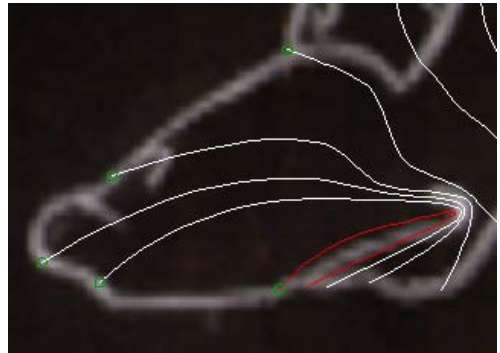

5. Save your work as **goco_right.max**.

If you change the view to a Front view, you can see that while the contours of the head match the profile, they don't yet match the face of the character. The next step is to adjust CVs to match the scanned drawing, *head_front.png*. You can work on this if you want to, but we've prepared a file to take you farther along the way to completing the character's head. In the next topic, you load that file.

Tip: If you do work on completing contours for the Front view, work in a Perspective view as well as Front. This helps you distinguish one curve from another. Also, the Soft Selection feature for moving CVs (on the Soft Selection rollout below the Curve CV rollout) lets multiple CVs follow a single one as you move it. This can be useful when you adjust the curves.

Previewing the Head

In this lesson, you use an existing file to preview the shape of the head.

Open a scene with completed contours:

- Open the file *tut_goco_00.max*.
Files for this tutorial are in the *|tutorials|nurbs_modeling* directory.

Set up the viewport backgrounds:

1. Make sure the Right viewport is active. Choose Views menu > Viewport Background.
2. In the Viewport Background dialog, click Files and choose *head_side.png* as the background source.

Files for this tutorial are in the *|tutorials|nurbs_modeling* directory.

3. Make sure Match Bitmap and Lock Zoom/Pan are turned on, then click OK.

You might have to adjust the position of the NURBS model to align it with the bitmap.

Tip: Whenever you need to adjust the position of the background relative to the model, use **CTRL+ALT+B** to toggle Lock Zoom/Pan. When Lock Zoom/Pan is off, the model zooms and pans independently of the background. When Lock Zoom/Pan is on, zoom and pan affect both the model and the background.

Tip: Another way to view reference images while you model in 3ds Max is to display them using the Asset Browser.

4. Make the Front viewport active, and then choose Views > Viewport Background.
5. In the Viewport Background dialog, click Files and choose *head_front.png* as the background source.
6. Make sure Match Bitmap and Lock Zoom/Pan are turned on, then click OK.

Again, you might have to adjust the position of the NURBS model to align it with the bitmap.

7.  Select the NURBS model so it shows up better against the backgrounds.

The Right viewport shows the profile, and the Front viewport shows the face. You can see that the two drawings don't completely match up. This is often the case when you build a model from drawings created in 2D. A 3D model can't exactly match both elevations, so you have to choose a compromise that is truest to the spirit of the character. In the case of Goco, the profile of the snout has been made shorter to better match the wideness of the full face.

Preview the head:

1.  Go to the Modify panel, and then select the NURBS model.

2.  On the General rollout, turn on NURBS Creation toolbox to display the toolbox.

Tip:  Whenever a NURBS model is selected and the Modify panel is active, you can toggle display of this toolbox by pressing CTRL+T (make sure the Keyboard Shortcut Override Toggle is turned on).

3.  In the toolbox, click Create U Loft Surface.

The U Loft Surface rollout is displayed on the Modify panel. A U Loft is a NURBS surface sub-object that stretches across contour curves.

Most NURBS sub-object types have an associated rollout. Usually this rollout is displayed at the bottom of the Modify panel. For example, the rollout for CV curves such as the contours you are working with is displayed below the long Curve Common rollout.

One advantage of using the NURBS Creation toolbox to create NURBS sub-objects is that during creation, while a toolbox button is on, the rollout for that type of sub-object appears near the top of the Modify panel, just below the Modifier Stack rollout.

4. Turning on U loft creation displays the U Loft Surface rollout. On this rollout, make sure Display While Creating is turned on.

Turning on this option can slow down 3ds Max, but for the purposes of this tutorial, you want to see what's happening.

5. Click each contour curve once, in spatial order, beginning with the mouth and proceeding to the base of the neck.

As you move the mouse, curves turn blue to indicate that you can pick them for use by the U loft.

After you have clicked the third contour, 3ds Max begins to display a surface that stretches across the contours. However, the surface appears to be incomplete. In fact, it is simply facing the wrong direction.

Tip: While you're creating the U loft, pressing BACKSPACE undoes the last section that you created (between one contour and the next).

Tip: If your mouse has a middle mouse button, you can use ALT+middle mouse button to arc-rotate the viewport while you create the loft. This can help you see the contour curves.

6. Right-click to end loft creation.
7. Turn on Flip Normals.

Now the surface appears correctly convex, and shows one-half of Goco's head.

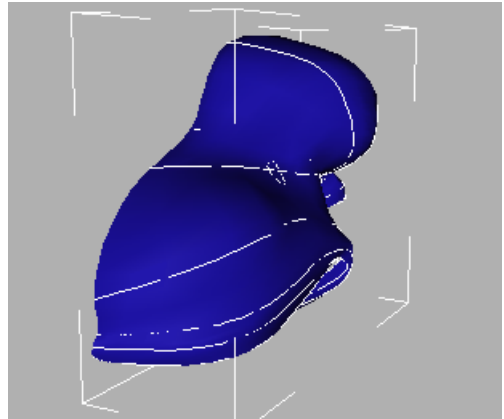

8. Save your work as **goco_loft.max**.

At this stage, you might notice things about the model you want to correct. You can go into Surface sub-object level, select the U loft, and then on the U Loft Surface rollout turn on the Edit Curves button. Edit Curves is a shortcut that lets you edit contours without having to switch back and forth between the Curve and Surface sub-object levels. It lets you move the CVs of curves in the U loft. Select the curve's name in the U Curves list, and then move its CVs.

While Edit Curves is turned on and a curve is selected in the U Curves list, other curve and CV editing rollouts are displayed below the U Loft Sub-Object rollout. You can edit the curve using the available controls in these rollouts, as well.

The U loft you created in this lesson is not the final surface for the head. First, you are going to add a bit more detail, and then mirror the contour curves.

Creating the Eye

In this lesson, you create an eye. The eye begins with a curve on surface, which you then use as the basis for the bulge of the eyeball.



Create the first contour curve for the eye:

1. Open the file *tut_goco_01.max*.

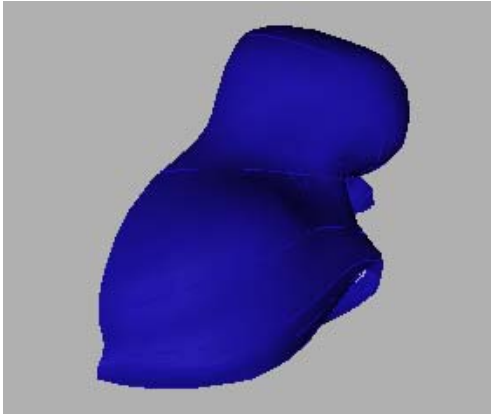
This file shows the temporary U loft of half the head.



Note: (If you want, you can open the work you saved in the last topic, *goco_loft.max*, instead. Maximize the Perspective viewport and adjust it until it looks like the illustration.)

2.  Go to the Modify panel and select the NURBS model.
3.  In the NURBS toolbox, click Create CV Curve on Surface.

As its name indicates, a CV curve on surface is like the CV curve sub-objects you have been working with already, but it is constrained to lie on a NURBS surface sub-object such as the U loft that shows half of Goco's head.

A curve on surface is an example of a *dependent* NURBS sub-object. NURBS sub-objects are described as dependent if they are constrained by other NURBS geometry. A U loft is also a dependent sub-object, because it depends on the contour curves, which are *independent*. While you edit a NURBS model, 3ds Max displays independent sub-objects in white, and dependent sub-objects in green.

(You can use Customize > Customize User Interface > Colors tab to choose a custom color for dependent NURBS sub-objects. For example, choose Geometry as the Elements type, choose NURBS Dependent Object, and then assign your own color to this element.)

4. In the Perspective viewport, use the CV curve on surface to draw a clockwise oval that is the base of the eye. Use seven or eight CVs in this curve. Click to position the first CV, then click to position the other CVs in an oval shape. Finally, click above the first CV, and answer Yes in the Close Curve dialog that appears.

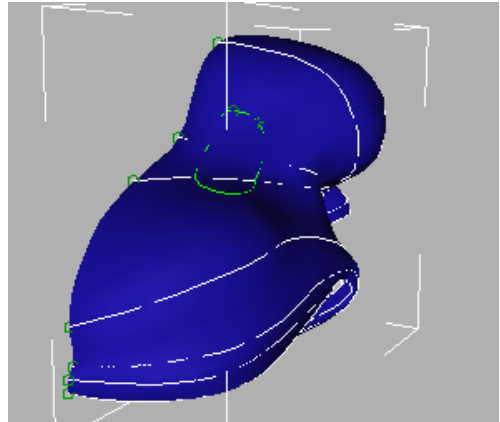

Tip: Zoom in a bit so it's easier to see the eye region of the head.

If the curve you create isn't shaped quite right, you can move CVs at the Curve CV sub-object level.

Note: As the illustration shows, the curve on surface doesn't display well.

5. Go to the Curve sub-object level.
6. Select the CV curve on surface that you just created.
7. On the Curve Common rollout, click Convert Curve. In the CV Curve tab of the Convert

Curve dialog, choose Number and enter **10** as the number of CVs in the curve. Click OK.

The eye contour curve is now an independent CV curve. It is no longer constrained to be on the U loft surface, although it still retains the shape it obtained from the surface.

Create the other contour curves for the eye:

1. Right-click the Perspective viewport label, and under Views, choose Right.



2. SHIFT-clone the eye's contour curve, moving the clone so the new curve stands out from the face about 0.4 inch. In the Sub-Object Clone Options dialog, leave Independent Copy chosen, and click OK.

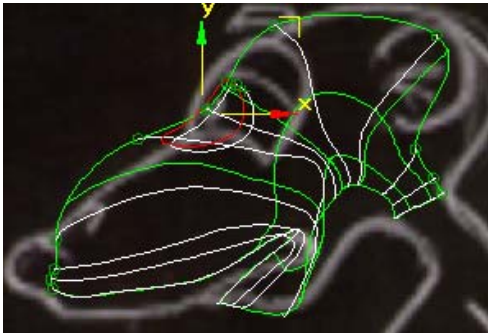

3. Right-click the Right viewport label, and under Views, choose Perspective.
4. Click the second contour curve.



5. On the toolbar, choose Select and Uniform Scale. Also on the toolbar, choose Screen as the Reference Coordinate System (in the drop-down list to the right of the Scale flyout).
6. SHIFT-clone the second eye contour, scaling down to about 80%. In the Sub-Object

Clone Options dialog, leave Independent Copy chosen, and click OK.



7. SHIFT-clone the third eye contour to create a fourth. Scale this contour down to 2%. In the Sub-Object Clone Options dialog, leave Independent Copy chosen, and click OK.

Making the center contour very small ensures that when you loft the eye, the center of the loft will be smooth and fairly flat.

Warning: Don't scale down to 1% or 0%. This can cause problems.

Loft the eye:



1. Zoom in on the region of the eye.

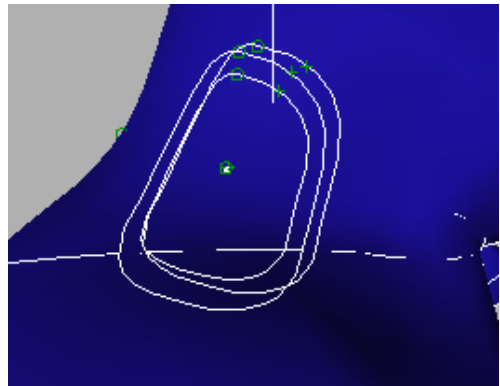

2. In the NURBS toolbox, turn on Create U Loft Surface.
3. Click the eye contour curves in the order you created them, beginning with the curve that originally lay on the head, and ending with the point-sized curve in the center of the eye.
4. Right-click to end creation of the U loft.

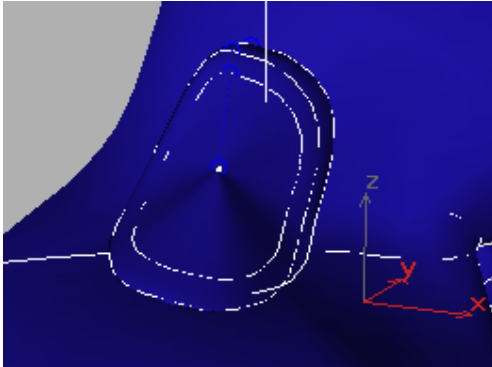

At this point, you might want to use Edit Curves (described at the end of *Previewing the Head* (page 1-97)) to adjust the eye some more.

5. Save your work as **goco_eye.max**.

Creating the Ear

The ear is the last detail of the head to create before you mirror the half-head to create the whole. While you don't actually create the ear in this lesson, you use a good technique for connecting one surface to another.

Loft the ear:

1. Open the file *tut_goco_02.max*.

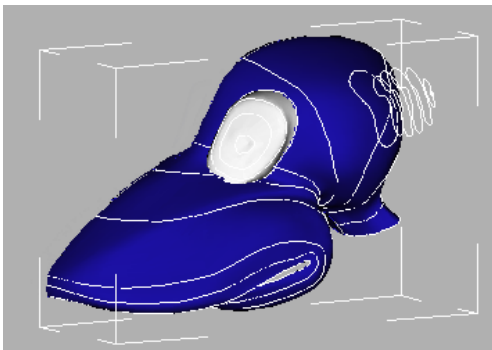



This file contains a nearly completed version of half Goco's head. The contours for the ear were created in much the same way you created the

contours for the head itself. The Soft Selection feature (on the Soft Selection Rollout for CV sub-objects) was used to create the dimple in the center of the ears.

Note: The eyes are white because a Multi/Sub-Object material has been applied to the head, as you can see if you open the Material Editor. The head and ear surfaces have material ID 1, which corresponds to the blue sub-material, and the eyes have material ID 2, which corresponds to the white sub-material. The white sub-material uses a Gradient map to create a dot in the middle for Goco's pupils. (You can see this map only when you render the model of Goco.) You assign material IDs to NURBS surface sub-objects using the surface sub-object's Material Properties rollout.



Go to the Modify panel and select the NURBS model.

2.  Zoom in on the region of the ear.
3.  In the NURBS toolbox, turn on Create U Loft Surface.
4. Click curves for the U loft from the top of the ear toward the head. Start at the very small curve at the tip of the ear, and end at the curve on surface that lies on top of the head.
5. Right-click to end U loft creation.
6. On the U Loft Surface rollout, click to highlight **Curve on Surf 01** in the U Curves list, and then in the Curve Properties group box, turn on Use COS Tangents.

Use COS Tangents (Curve on Surface tangents) makes the loft tangent to the surface that is the parent of last curve (Curve on Surf 01) in the loft. This is a good technique for connecting one surface to another. Although you don't model the entire figure in this tutorial, Use COS

Tangents is also used to connect the arms and legs to the torso of Goco.

Note: You might have to turn on Flip Tangents to get the correct appearance of the ear.

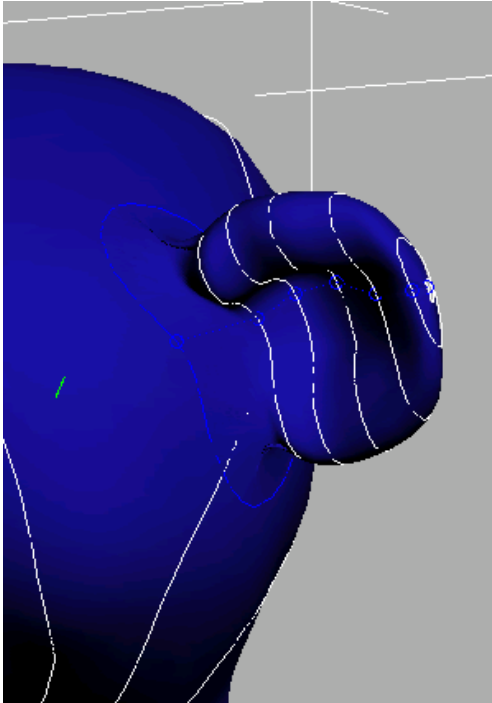

7. Save your work as **goco_ear.max**.

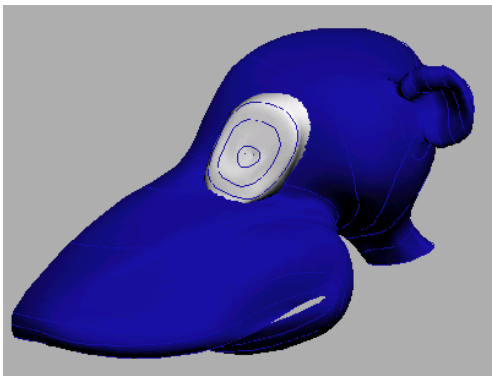



Mirroring and Lofting the Head

In this lesson, you create a complete head surface. First you mirror the half-head, then you use Join to connect the contour curves. Finally, you loft the connected curves.

Mirror the head:

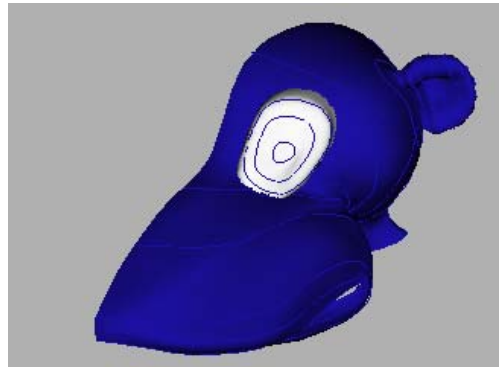
1. Open the file *tut_goco_03.max*.



2. Select the NURBS model.
3.  Choose Tools menu > Mirror. In the Mirror: World Coordinates dialog, leave X chosen as the mirror axis. Set the Offset to **-0.5"** (inches), choose Copy, and then click OK.

Make sure the offset is negative, or you will get a weird overlap between the two halves.

The head is now mirrored, with a slight gap between the two halves. The newly copied half is selected.

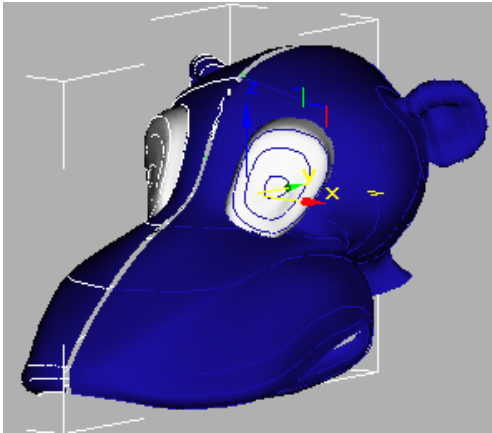

4.  Go to the Modify panel.
5. On the General rollout, turn on the Attach button, and then click the original half of the head.

Attach makes both halves part of the same NURBS model.

Remove the temporary U lofts:

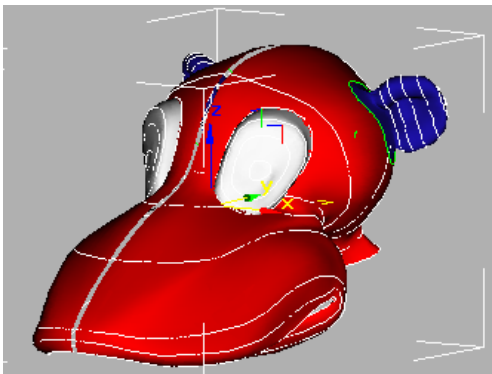

1. Right-click in a viewport, and then go to the Surface sub-object level in the modifier stack.
2. Click to select one of the surface halves, and then hold down CTRL while you click the other. Both halves of the head should be selected. (You can leave the eyes and ears as they are.)

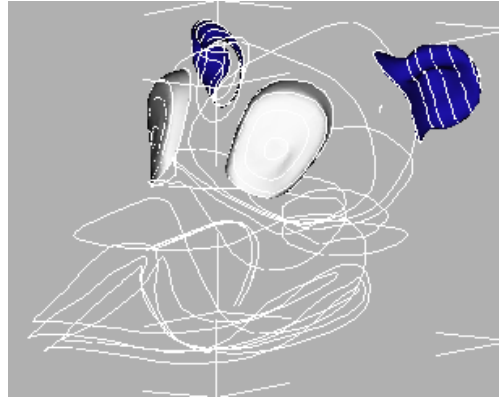

3. On the Surface Common rollout, click Delete. Now the head consists of just the eyes, the ears, and the contour curves.



Connect the contour curves:

1.   Use Zoom and Arc Rotate to move the model so you can easily see the gap between the contour curves of the two halves.

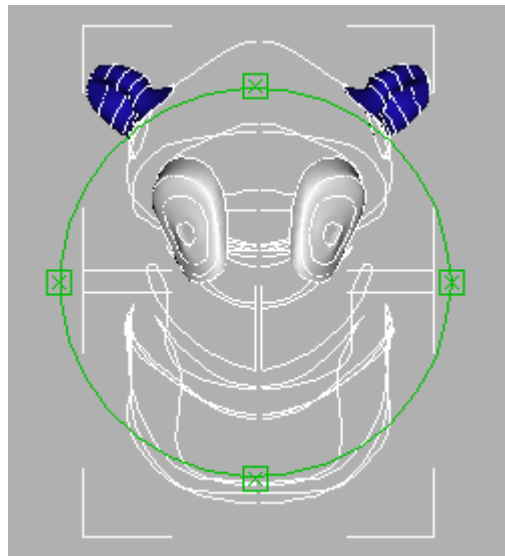

2. Go to the Curve sub-object level.
3. On the Curve Common rollout, turn on Join. Click the end of one curve near the gap. The

curve is highlighted in blue, and a blue square is displayed, showing the end that will be joined. Drag to the corresponding curve. The second curve is also highlighted in blue, with a square to show the end that will be joined. When you have matched the curves you want to join, release the mouse button.

4. In the Join Curves dialog that appears, click OK or press ENTER to use the defaults (the ZIP tab is active by default, and this is the best way to join two curves).

Steps 3 and 4 can be tricky, because it can be difficult to see where the curves are, and which ends should match. Follow these guidelines:

- For consistency's sake, move from top to bottom and left to right.
- Before you join, make sure the joined curve (highlighted in blue) appears symmetrical. Do *not* join mismatched curves.
- Join only the final ends of curves. Do not join if a small green circle appears in the blue highlight box. This indicates the start of a curve. (After joining the final ends, you will close the curves all at once.)



- Zooming in and panning to get a closer view can help you locate the ends to join.
 - Save your work frequently so you don't have to backtrack too far if you make a mistake. (If you run into trouble during this step, you can skip ahead to the next group of steps, "Loft the head," where you can load a prepared file.)
5. When you've joined all the contour curves, use CTRL to select all of the contours.
 6. On the CV Curve rollout, click Close. Close will be unavailable if you didn't connect all of the paired curves.

Now all the contours of the two halves of the head are joined together, and you're ready to complete the head.

7. Save your work as **goco_closecurve.max**.

Loft the head:

1. Either continue to use *goco_closecurve.max*, or open the file *tut_goco_04.max*.

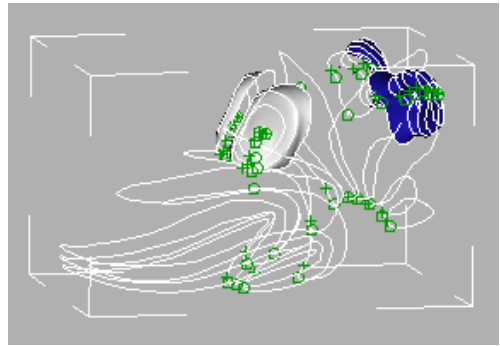

2.  In the NURBS toolbox, turn on Create U Loft Surface.
3. Create the final loft of the head. Begin creating the loft at the base of the neck, and proceed forward to the mouth.

Tip: If you aren't sure you've picked curves in the right order, highlight each curve using the U Curves list on the U Loft Surface rollout. If a curve is out of order, highlight its name in the U Curves list, then change its position by clicking the buttons with up and down arrows just above the U Curves list.

4. Examine the end result in the viewport. Notice that there is a fair amount of creasing and unwanted bulging on the nurbs surface over the upper jaw and around the eyes. This is due to a large number of unnecessary CV points that were automatically inserted when you joined/closed the curves earlier.

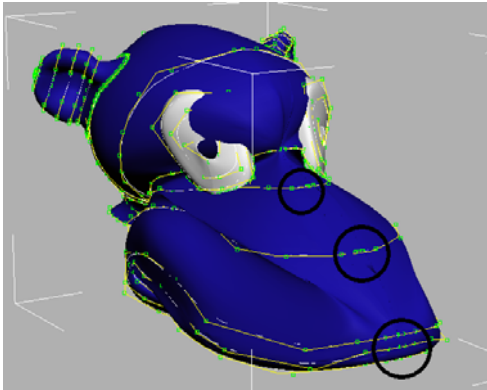

5. On the Modify panel, go to Curve CV sub-object mode. Zoom in and adjust your view so you can have a better look at the center line of the head.
6. Select and delete the CV points along the mirror axis of the head. Try not to have more than one or two CV points on each curve along the mirror plane. When you are done, you should have a much smoother surface for the head of the character.

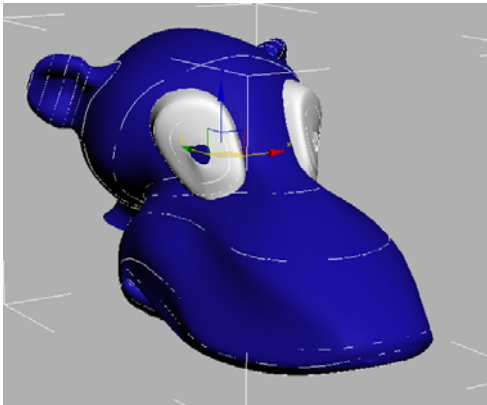

Completing the Head

In this lesson, you complete the head by restoring the connections between the main head surface and the eyes and ears. The eyes and ears are based on curves that reside on the surface of the head,

but when you deleted the temporary U lofts, these curves were converted back to independent CV curves. You need to attach them again, to avoid seeing gaps when you render Goco's head.

Tip: After completion, you can experiment by converting the head to an Editable Patch surface and trying some of the new smoothing improvements.

Attach the left ear again:

1. Open the file *tut_goco_05.max*, and select the head.
2. Go to the Curve sub-object level.
3.  In the NURBS toolbox, turn on Create Normal Projected Curve. Drag from the last curve in the left ear, the one that originally resided on the temporary surface, to the new head surface.

A new normal projected curve is created. It is displayed in green rather than white, because it is a dependent curve. The old curve and the new curve occupy nearly the same location.

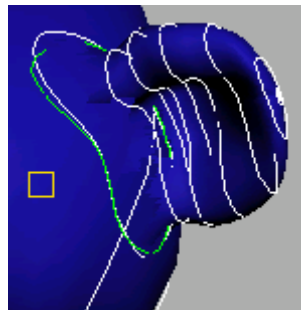

4.  Still at the Curve sub-object level, select the *old* curve, the white one, and press DELETE.

DELETE is a shortcut for clicking Delete on the Curve Common rollout.

The last section of the U loft that forms the ear disappears.

5. Go to the Surface sub-object level.
6. Select the ear.
7. On the U Loft Surface rollout, at the bottom of the Modify panel, highlight the ----- **End** ----- marker in the U Curves list, and then turn on Insert.

When you insert a curve into a U loft, it always appears above the highlighted entry. Highlighting the ----- End ----- marker makes the new curve the last one in the loft.

8. When you move the mouse over the new normal projected curve, it is highlighted in blue to show you can add it to the U loft. Click the new curve while it is highlighted.

Now the ear is connected to the head again.

9. On the U Loft Surface rollout, highlight Normal Projected Curve in the U loft list, and then turn on Use COS Tangents.

As with the temporary surface, this makes the loft of the ear blend smoothly into the head.

You might have to turn on Flip Tangents to get the correct appearance of the ear.

10. Change the Tension to **0.5**.

The Tension spinner is another way to adjust the effect of a curve on a loft. Decreasing tension pulls the surface toward the curve. Increasing tension (use large values) pulls the surface toward the neighboring curves.

Attach the other ear and the eyes:

- Repeat the previous steps, 1 through 9, for the right ear and the two eye surfaces.

Now the eyes and ears are fully and smoothly connected.

Render your work and save it:



1. Render the head. It should look similar to the illustrations.



2. Save your work as **goco_fullhead.bmp**.

This completes the tutorial for creating Goco's head.

Summary

The NURBS modeling tools are ideal for modeling organic objects. When modeling characters, be sure to use a reference picture to help you create the object correctly.

Modeling an Apple

In this tutorial, you create an apple. You will add Taper and Displace modifiers to reshape a sphere

to look like an apple, then use additional tools to improve its shape and add a stem.

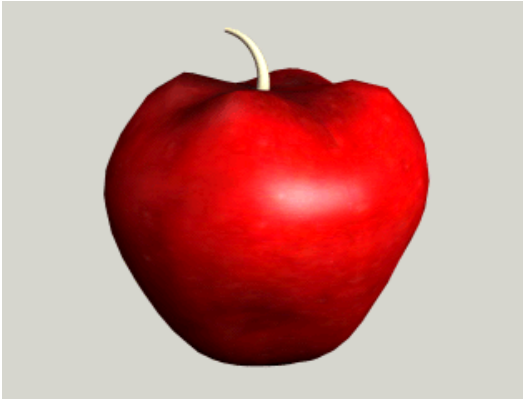

Skill Level: Beginner

Time to complete: 25 minutes

Features Covered in This Tutorial

- Taper modifier
- Creating sub-object selection sets
- Using soft selections to blend changes to a mesh
- Using a Displacement modifier to shape your mesh
- Using a Bend modifier to shape a stem

Tutorial Files

All the necessary files for this tutorial can be found on the Tutorial Files CD in the *tutorials\intro_to_modeling* directory. Before starting the tutorials, copy the *tutorials* folder to your local *3dsmax8* installation.

Creating the Basic Apple Shape

First you will create the basic apple shape from a sphere and modifiers.

Create the apple:

1. Choose File > Open and open the file *tut_apple_start.max* from the *tutorials\intro_to_modeling* folder. Highlight the file and click Open.
There is no geometry in this file; however, it does contain a material you will need.
2. On the Create panel, under Standard Primitives > Object Type, click Sphere.
The button turns yellow, indicating the Sphere command is ready for you to make a sphere.
3. In the Top viewport, drag to create a sphere that has a Radius of 10.
4. In the Name and Color rollout, name the sphere **apple**.
5.  Click Zoom Extents All to zoom all the viewports.

Change the rendering background color:

You'll be able to see the apple better if you render it against a white background.

1. From the Main menu, choose Rendering > Environment to display the Environment and Effects dialog.
2. In the Common Parameters rollout > Background group, click the black Color box to display the Color Selector dialog. Set Value to **255** and click Close to accept the value and close the dialog.
3. Close the Environment and Effects dialog.

Apply an apple material:

1. Press **M** on the keyboard to open the Material Editor.
2. From the Material Editor, drag the material *shiny apple* to the apple sphere in any viewport.
3. Close the Material Editor.



4. Right-click in the Perspective viewport to activate it. On the Render toolbar, click Quick Render. Or press **F9** on the keyboard to render the viewport without clicking a button.



Rendered apple against White background

Taper the apple:

Selecting what you want to work on is the first step in modeling. Until you make a selection, all modifier choices are unavailable. In this case, the apple should be selected; when selected, its wireframe mesh is displayed in white.

Modifiers can be selected from the Modifier List on the Modify Panel, or from the Modifiers Menu. Here you'll use the menu option at the top of the interface.

1. On the 3ds Max menu bar, on the Modifiers menu, choose Parametric Deformers > Taper to apply this modifier to the sphere of the apple.
2. In the Parameters rollout > Taper group, adjust the Amount parameter and watch the effect in the viewports. You only need a small amount of taper. Adjust the parameter to about **0.85**.
3. On the Parameters rollout > Taper Axis group, set Primary to **Z** and Effect to **XY**.

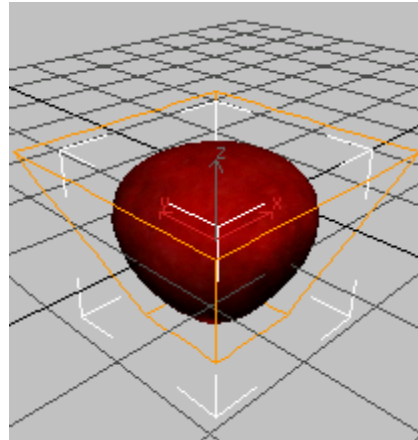

Improving the Shape of the Apple

The Taper modifier produced a rough reshaping of the apple's original sphere. To achieve more realism, you will collapse the sphere into an editable mesh and use Soft Selection to adjust the transition between selected and unselected areas.

Shape the lower half of the apple:

What you see in the viewports is a tapered wireframe of the whole apple. For more detailed modeling, you need to select only part of the apple, such as the lower half. By collapsing the sphere to an editable mesh, you can make a soft sub-object selection.

1. With the apple selected, go to the Modify panel > modifier stack display (below the Modifier List), right-click the object name, and then choose Collapse All. Click Yes in the Warning dialog.

Tip: If you are unsure about collapsing the stack, click Hold/Yes instead. You can revert the scene to the current state by selecting Edit > Fetch from the menu bar.

The tapered sphere becomes an editable mesh.

Tip: You can also convert a selected object to an editable mesh in the active viewport by

right-clicking the object and in the quad menu > Transform quadrant > Convert To > Convert To Editable Mesh.

- In the stack display, click the plus sign (+) next to Editable Mesh to expand its sub-object levels.

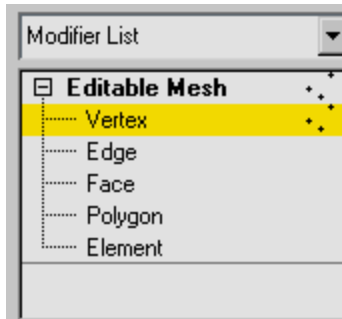

- Choose Vertex from the level list.

In the viewports, the vertices appear, highlighted in blue.

- Activate the Left viewport.
-  Click Zoom Extents All in the viewport navigation controls.

The apple is enlarged in three viewports.

- In the Front or Left viewport, drag from outside the sphere to make a dotted box around the bottom two or three rows of vertices of the apple. As you release to complete the box, the selection is made, and the vertices turn red.

This technique is called region-select. It's the most common method for making sub-object selections.

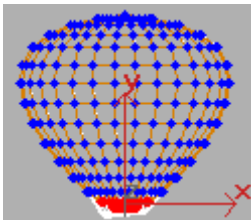

Name the sub-object selection:

With hundreds of vertices or faces, sub-object selections are often hard to recreate exactly. So it's a good idea to give these selections a name you can recognize later. Any selection (object or sub-object) can be named and retrieved in 3ds Max. As your modeling skills develop, you'll begin to recognize the advantages of named selection sets.

- On the Selection Sets toolbar, toward the right side of the interface, you'll find a blank list. This is where you name the current selection. In this case, type in **bottom of apple** and press ENTER.

This selection name is stored with the file.

You might have many named selections on a single object, but you will only see **bottom of apple** in the list when you return to the Vertex level of the editable mesh. At this level, you could make multiple selections and give them each a different name. You could then experiment with which selection works best for the modeling effect you want.

Use Soft Selection to blend changes to your mesh:

The Soft Selection setting helps the selected region blend with the rest of the object.

- In the Modify panel, scroll to and open the Soft Selection rollout.
- Turn on Use Soft Selection.

The vertices are now displayed in a graduated color ramp.

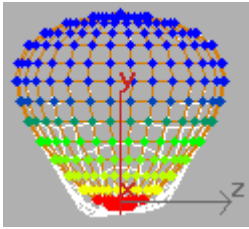

3. Adjust the Soft Selection Falloff setting watching the viewport shading change until the lower half of the apple is affected.

Completing the Apple

This lesson continues from the previous one. You are working at Vertex level with Soft Selection active. The bottom half of the apple is selected.

Apply a displacement modifier to your apple:

Here you apply a Displace modifier to move only the currently selected vertices on the bottom of the apple. You use a bitmap to control this movement, or displacement.

1. Make sure the Vertex sub-object selection is active (yellow) in the modifier stack and the vertices are visible in the viewport. Then, click the Modifier List drop-down arrow. From the Object-Space category in the drop-down list, choose Displace.

This applies the Displace modifier. You won't see much change until you adjust its parameters.

2. Adjust the Strength spinner in the Displacement group. You should see the effect happening only on the lower half of the apple.
3. On the Parameters rollout > Image group, click the Bitmap button labeled None.
4. In the Select Displacement Image dialog, choose *appledis.jpg*.

The preview window at the bottom of the dialog shows the bitmap you're applying.

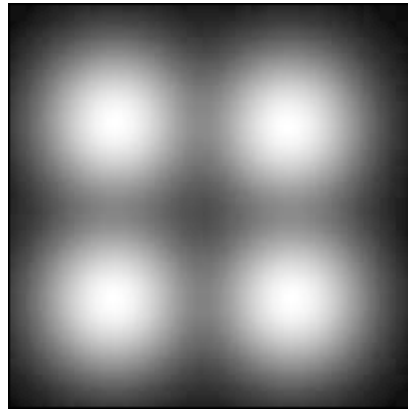

The bitmap is a black square with four fuzzy white blobs. The white areas will displace more than the black, producing the characteristic four bumps on the bottom of the apple. The fuzziness of the bitmap image creates a smooth transition.

5. Click Open to apply the bitmap.
6. In the Parameters rollout > Displacement group, drag the Strength spinners (the small arrows next to parameter fields) to increase and decrease the Strength parameter a little. Again watch the effect in the viewport.

Negative values push the bitmap image into the mesh. Positive values draw the image out, producing bumps. Try a value of **-5.0**. You can change this later if you need to.

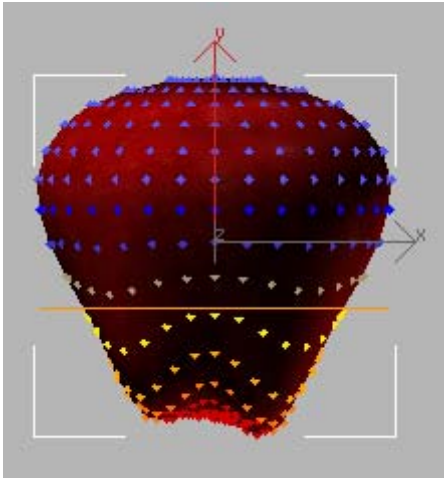

Complete the top of the apple:

To complete the apple shape, you'll add an Edit Mesh modifier to create a second soft selection, and then copy the Displace modifier to the top half of the apple.

1. On the Modify panel, choose Modifier List > Object-Space Modifiers > Edit Mesh.
2.  In the Selection rollout, choose Vertex.

Warning: You want the Vertex sub-object level of the new (top) Edit Mesh modifier. Not the Vertex level of the (bottom) Editable Mesh.

You are now working at the Vertex sub-object level.

3. Region-select the vertices on the top two or three rows of the sphere. Name the selection **top of apple**.

Tip: You might notice that the original Soft Selection vertices are still displayed. Once you have selected the vertices at the top of the apple and turn on Soft Selection, the newly selected vertices should display correctly.

4. Open the Soft Selection rollout. Turn on Use Soft Selection, and adjust Falloff to about **8.0**.

The modifier stack display shows you all the changes you've made to your object. The sphere is now shown at the bottom as an editable mesh. The successive modifiers that you applied to this sphere are above it.

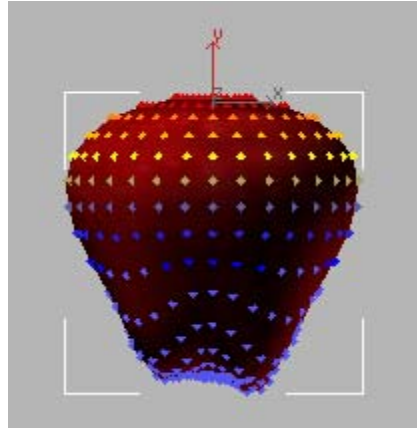

5. In the stack display, right-click Displace and choose Copy.
6. At the top of the stack display, right-click over Edit Mesh and choose Paste to add the duplicate Displace modifier to the stack.

Warning: Do not highlight the Edit Mesh in the stack display. This will turn off the sub-object selection. Instead, just right-click over the Edit Mesh entry.

A copy of the Displace modifier appears above the Edit Mesh modifier in the stack, and its effect has been applied to the top of the apple selection.

7. In the Parameters rollout > Displacement group, set Strength to **2.0**.
8. Right-click in a viewport and choose Sub-Objects > Gizmo from the Tools1 quadrant of the quad menu.

In the stack display, the Displace entry turns yellow to show that you're working at its sub-object level.

The gizmo is a control for the modifier and defines where and how the effect will take place. By placing the gizmo just above the apple, you can get the effect you want.

9. Move the gizmo so that it's floating above the top of the apple.

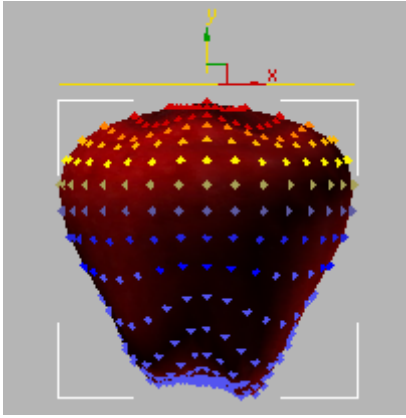

10. On the Parameters rollout for Displace, set the Decay parameter **1.5** to model the top surface into a characteristic apple shape. Again adjust the Strength parameter to fine-tune your effect.
11. In the stack display, click the Displace entry to exit the sub-object level and turn off the yellow highlighting.

Adding a Stem to the Apple

In this lesson, you add some more visual interest to the apple. To create the stem of the apple, you make a cylinder using the AutoGrid feature to build the stem on the surface of the apple. You then add a Bend modifier to finish the stem.

Create the stem:

When you build an object in a viewport, the object is constructed on a grid. Up until now, you have been using the home grid to build the apple. Now you'll try using the AutoGrid feature. This uses

a roving grid that is automatically created off a surface using face normals.

1. On the Create Menu, choose Standard Primitives > Cylinder.

The Cylinder button highlights on the Create panel.

2. On the Create panel > Object Type rollout, turn on AutoGrid. This is a small check box directly under the Object Type rollout.
3. In the Top viewport, move the cursor over the apple.

A tripod follows the cursor showing where the cylinder will be created. Try to locate the center of the top of the apple.

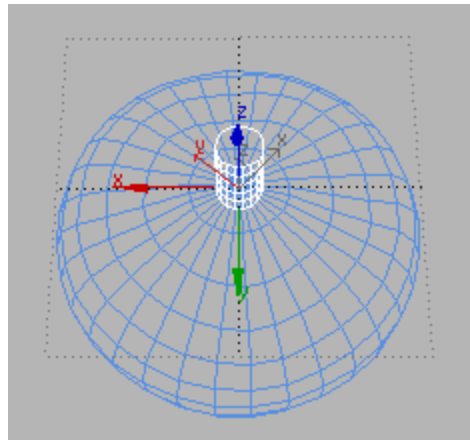

AutoGrid lets you create the stem on top of the apple.

4. Add a cylinder on top of the apple. First drag and release to draw the base of the cylinder, and then move the mouse to set its height. Click to finish.

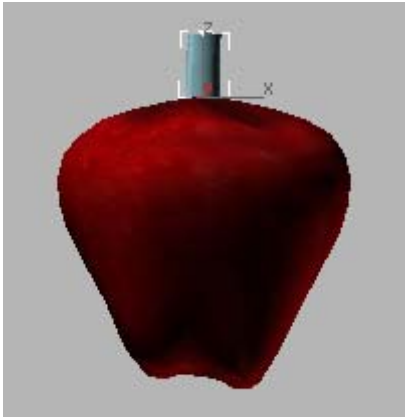

5. In the Name And Color rollout, change the color of the cylinder to green and name it **stem**.
6. On the Parameters rollout for the stem, set the following:
 - Radius=0.5
 - Height=4.0
 - Height Segments=12
7. On the Object Type rollout, turn off AutoGrid.
8. On the Modifiers list, choose Object-Space Modifiers > Bend.

This applies a zero-degree Bend to the cylinder.

9. On the Parameters rollout for the Bend modifier, adjust the Angle setting to bend the stem. Plus or minus **60** is about right. Experiment with the Direction parameter, although you can leave it at 0 if you want.



10. Right click in the Perspective viewport to active it, and press **F9** to render last.



Rendered apple

If you want your stem to be similar to the one in the bottom illustration, apply a very slight Taper modifier below the Bend.

11. Highlight the Cylinder in the stack display.
12. Add the Taper modifier at this point, it will then taper the cylinder before it is bent.

Warning: Applying the Taper modifier after the Bend will produce entirely different results.

After Adjusting the Taper modifier, highlight Bend to reactivate it.

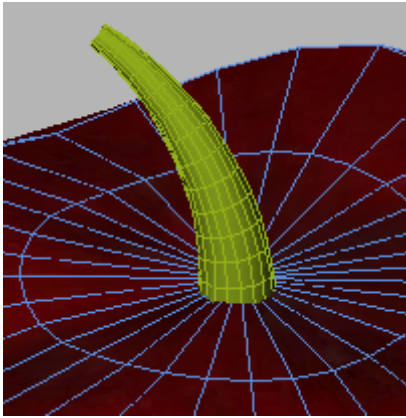

The cylinder is first tapered, then bent.

Save your work:

- Choose File > Save As. Save your work as *my_apple01.max* in your appropriate local folder.

Note: A completed file, *tut_apple_complete.max* is also available in the *tutorials\intro_to_modeling* directory.

Summary

In this tutorial, you learned how to start with a primitive and shape the object using the Editable Mesh tools. You also learned how you can use displacement mapping to make an object appear more organic.

Materials & Mapping

Introduction to Materials & Mapping



Materials are like paint. With materials, you make apples red and oranges orange. You put the shine in chrome and the polish on glass. By applying maps, you can add images, patterns, and even surface texture to objects. Materials are what make your scenes look real.

Mapping is a method of projecting pictorial information (materials) onto surfaces. It is a lot like wrapping a present with wrapping paper, except the pattern is projected mathematically, with modifiers, rather than being taped to the surface.

This tutorial introduces the Material Editor, the master design studio for materials and maps. In the following lessons, you will learn how to assign materials to objects, how to create basic materials, and how to create several kinds of advanced materials.

Skill level: Basic to intermediate

Time to complete: 90 minutes

Features Covered in This Tutorial

In these lessons you will learn:

- Accessing materials from material libraries, scene objects, and other MAX files.
- Assigning materials to scene objects.
- Creating basic materials, including wireframe, 2-sided and self-illuminated.
- Using ambient color and light with materials.
- Creating additive and subtractive transparency.
- Using shaders.
- Using texture, opacity and bump mapping.
- Creating and adjusting mapping coordinates.
- Creating multi/sub-object materials using drag and drop.
- Creating a raytrace material.
- Using displacement mapping.
- Creating stars using noise.
- Using Shellac material to create realistic human skin.

Tutorial Files

Files for this tutorial are in the `tutorials\intro_to_materials` folder.

Note: All the necessary files to do the tutorials can be found on the Tutorial Files CD that ships with 3ds Max . Before doing the tutorials, copy the `tutorials` directory from the CD to your `13dsmax8` local installation.

Accessing Materials



Examples of different materials

When you work with 3ds Max, you access materials from three different places: from the Material Editor, from scenes, or from an external collection of predefined materials called a *material library*. The next exercise shows you how to load materials from a material library into the Material Editor.

The files for this lesson can be found in the `tutorials\intro_to_materials` folder.

Load a material library:

1. Start or reset 3ds Max.

If you receive the dialog asking if you really want to reset the program, answer Yes.

2. Open `intro_materials.max`.

Note: If you see the [File Load: Units Mismatch dialog](#), choose the option Rescale The File Objects To The System Unit Scale.

3. Press the **M** key on your keyboard to open the Material Editor.

The sample slot in the upper-left corner has a white border around it, indicating that it is active.

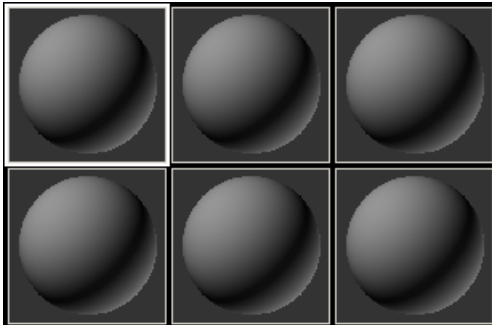

- Right-click the active sample slot. From the right-click menu, choose 5 x 3 Sample Windows. The sample palette redraws to display 15 slots.

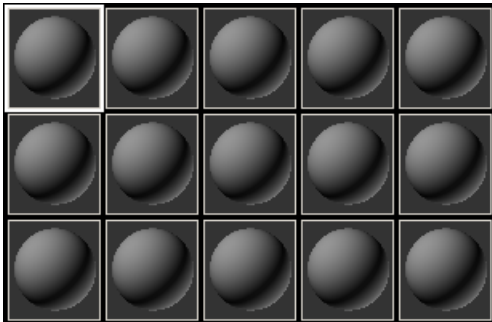
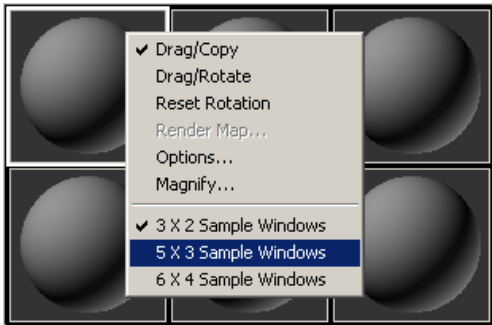

- On the Material Editor toolbar, click Get Material.

The Material/Map Browser appears.

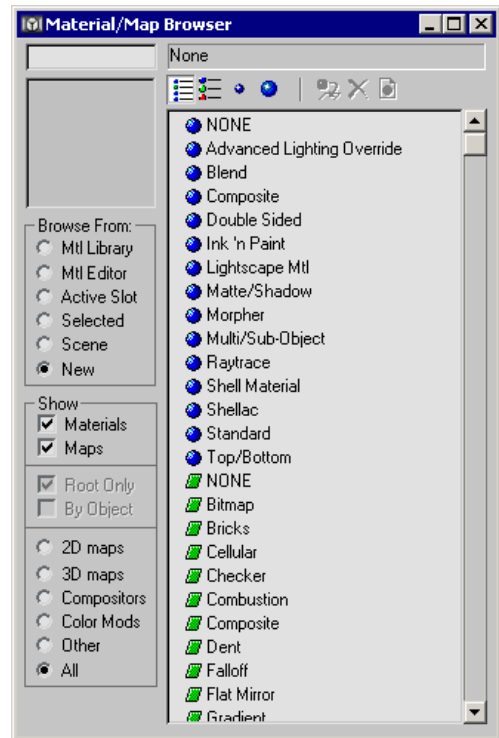

- In the Material/Map Browser > Browse From group, choose Mtl Library (Mtl stand for “Material.”)
- In the File group, click Open.

The default Material Library, *3dsmax.mat*, is displayed. A number of others might be listed as well.

- In the Open Material Library dialog, navigate to the *tutorials\intro_to_materials* directory and choose *stillife.mat*.

The names of the materials appear in a list.

- On the Material/Map Browser toolbar, click View List+Icons.

A thumbnail of each material appears next to its name.

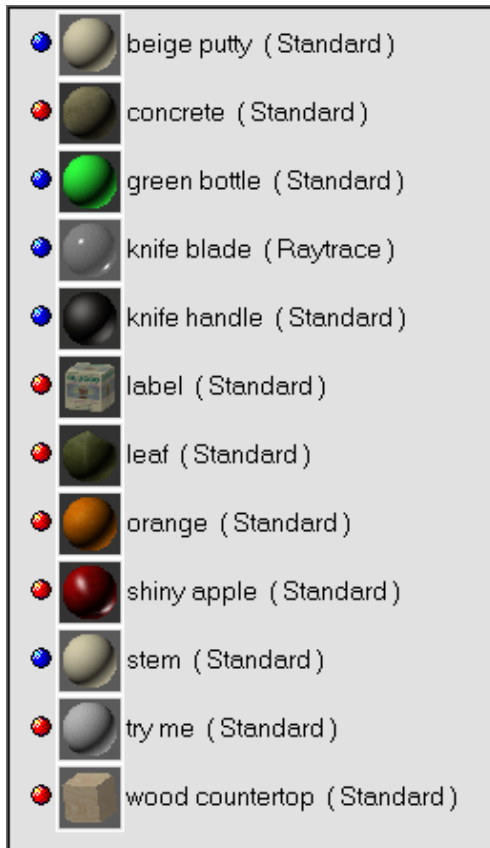

Transfer materials to the Material Editor:

1. On the Material/Map Browser, click the material named *orange*.
A larger thumbnail of the Orange material appears in the preview window.
2. Drag the thumbnail from the Browser to the active sample slot in the Material Editor. You can drag it from either the preview window or the list of materials.
The material appears in the sample slot. The name *orange* appears in the drop-down list just below the palette.

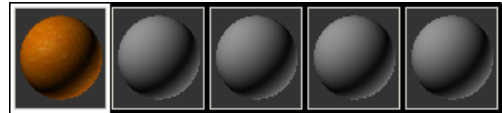

3. Click the next sample slot to the right. The slot becomes active.
4. On the Material/Map Browser, double-click *shiny apple*. The *shiny apple* material appears in the second sample slot.

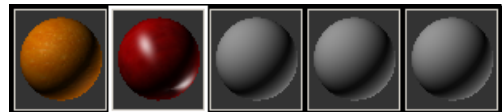

5. Scroll the Material/Map Browser to the bottom of the list, if necessary.
6. Drag the *wood countertop* material from the list to the third sample slot.

The third sample slot activates, displaying the *wood countertop* material.

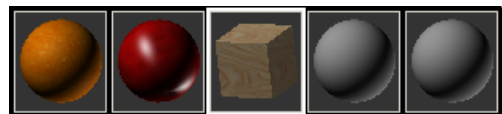

Get materials from a MAX file:

You can just as easily get materials from MAX scene files as from material libraries. The procedure is nearly the same.

1. Activate the sample slot to the right of the *wood countertop* material.
2. On the Material/Map Browser, check that Browse From is still set to Material Library.
3. Choose Open from the File group.
4. Pull down the Files Of Type list and choose *3ds Max (.max, chr)* instead of *.mat*.
5. Navigate to the `|tutorials|still_life` folder, and then open *Still_life_animated.max*.
6. Double-click the material named *leaf*.

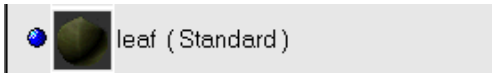

The leaf material is transferred from the MAX file to the Material Editor.

Get materials from objects in the scene:

There is a material already at work in this scene, but it is not in the Material Editor. It is applied to all the objects in the scene, so that they look like they are all made of the same substance. You can transfer the material from the scene to the Material Editor using the eyedropper cursor to sample the material.

1. Activate the fifth sample slot in the top row of materials.
2.  In the Material Editor, click Pick Material From Object. The button is located next to the material name, below the top row of icons (under the sample slots).
3. Use the eyedropper to click any object in the viewport.

The material, *beige putty*, appears in the sample slot. Because the material is currently assigned to objects in the scene and in the Material Editor, the corners of the sample slot display triangles. In 3ds Max parlance, this is called a "hot" material.

Note: If the triangular corners are hollow, this indicates the material is assigned to the scene. If the corners are solid, it means an object that has been assigned the material is currently selected.

For practice:

1. Transfer the rest of the materials from the material library into the Material Editor. Arrange them in a way that makes sense to you.
2. To copy and move a material, drag the sample to a new slot.

3.  To remove a material from a sample, press Reset Map/Mtl to Default Settings.
4. To view more sample slots, use the scroll bars at the right and bottom of the sample palette, or change the right-click settings to 6 X 4 Sample Windows.

Note: While the sample palette can show you 24 samples at any one time, there is no limit to the number of materials you can assign to a scene. Once a material is assigned to an object, that sample in the palette can be reset and a new material created.

5.  Pan the sample palette by dragging in between the slots.
6. To examine a material up close, double-click the sample slot, or right-click the slot and choose Magnify.
7. Save your file as **mymaterials1.max**.

Assigning Materials to Objects

In this lesson, you will learn two ways to assign materials to objects.

- The files for this lesson can be found in the *tutorials/intro_to_materials* folder.

Set up the lesson:

- Open *intro_materials2.max*.

Note: If you see the [File Load: Units Mismatch dialog](#), choose the option Rescale The File Objects To The System Unit Scale.

Assign a material to a selected object:

Making your selection before assigning a material to it ensures that the material goes exactly where you want it to go. Use this approach for mapping complex scenes, or when you want to assign materials to sub-object selections.

1. On the keyboard, press **H** to display the Select Objects dialog. Highlight *Orange* and click Select.
2. Press **M** to open the Material Editor.
3. Click the sample slot that contains the *orange* material.
4.  Click Assign Material to Selection. The object turns orange in the Camera01 viewport.

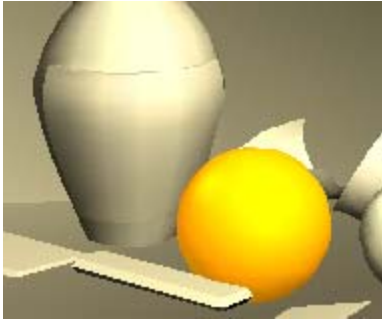

Assign a material using drag and drop:

Drag and drop is the most direct way to assign materials to objects. Use this approach when the objects you want to map are clearly visible in the scene.

1. In the Material Editor, find the sample slot that contains the *shiny apple* material.
2. Drag the sample onto the apple; a tooltip lets you know when the cursor is over the right object. The apple turns red.

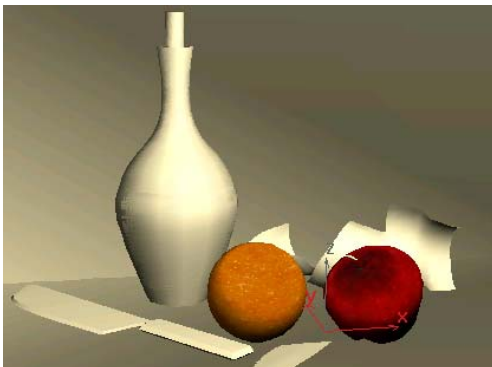

See the results:

1. Activate the Camera01 viewport by right-clicking in it.
2.  From the toolbar, click Quick Render. The view from the camera renders line by line in a separate window.

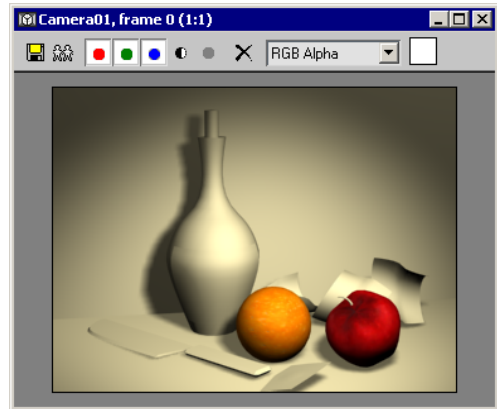

For practice:

- Assign materials to the rest of the objects in the scene. Use the tooltips to see the name of each object, or choose objects by name from the Select Object dialog. When you are done, render the scene to see how it looks.

Creating Basic Materials

In this lesson, you create variations on the Standard material type by changing basic parameters such as color, glossiness, transparency, and shader type.

- The files for this lesson can be found in the *tutorials/intro_to_materials* folder.

Set the diffuse and specular color:

The Blinn shader has basic settings for color, glossiness, self-illumination and transparency.

1. Open *intro_materials2.max*.

Note: If you see the [File Units: Mismatch dialog](#), choose the option Rescale The File Objects To The System Unit Scale.

- Press **M** to open the Material Editor. If necessary, set the display to 5 x 3 Sample Windows.
- Select the fifth sample sphere in the third row; the material is named *try me*.
- Rename this material using the editable name field above the rollouts. Call it **myorange material**.
- From the Material Editor, drag *myorange material* onto the Orange object in the viewport. The orange in the viewport turns gray.

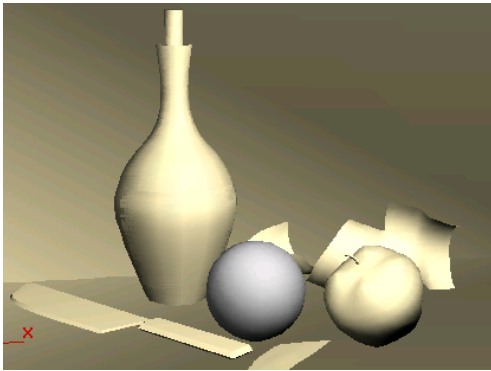

- On the Blinn Basic Parameters rollout, click the Diffuse color swatch to display the Color Selector. Change the Diffuse color to dark orange. Then close the Color Selector.

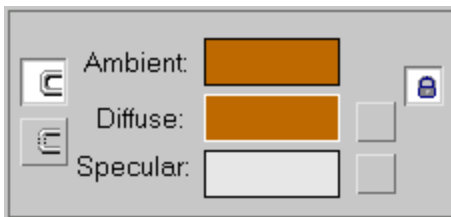

Both the Diffuse color and Ambient color change to dark orange, because the colors are

locked together. In the viewport, the Orange object's color changes to dark orange.

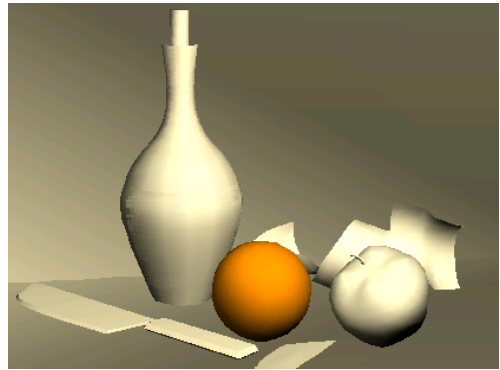

- In the Specular Highlight group, experiment with the Specular Level parameter by dragging the spinner up and down while observing the sample sphere. Then set the Specular Level to **100**.

A highlight appears on the orange. The highlight gets stronger as you increase the Specular Level.

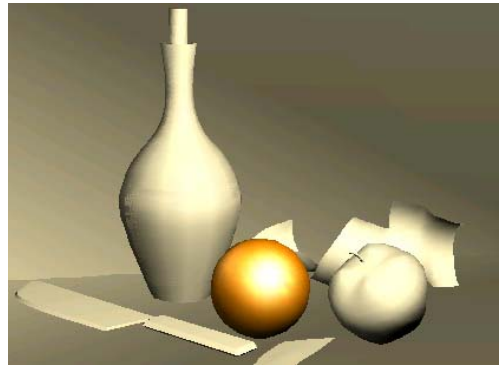

- Experiment with the Glossiness parameter by dragging its spinner up and down while observing the sample sphere. Then set the Glossiness to **40**.

As Glossiness increases, the highlight gets smaller and more focused. This is how you control the shininess of an object.

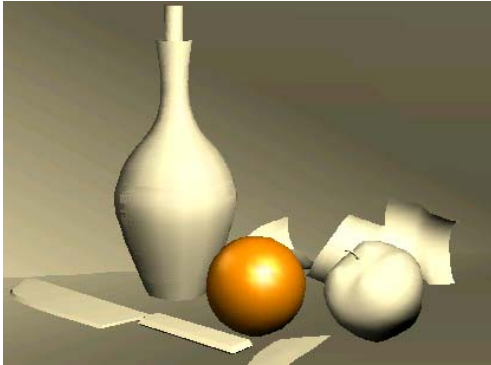

- Click the Specular color swatch and change the Specular color to a bright lemon yellow.

The highlight takes on a yellow tinge.

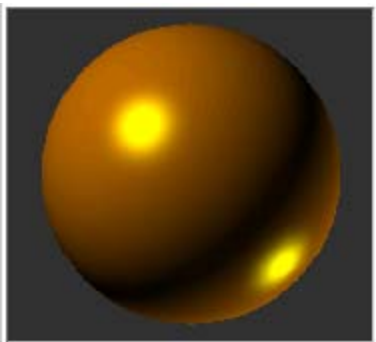

Use wire and 2-sided:

You can use the Wire material option to make an object render in wireframe.

- On the Shader Basic Parameters rollout, turn on Wire.

The surface of the orange displays in wireframe, rather than as shaded faces.

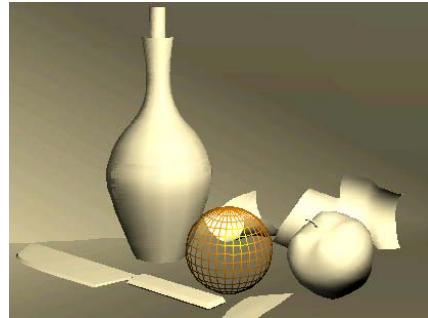

- Open the Extended Parameters rollout. In the Wire group, change the Size to 2.5.

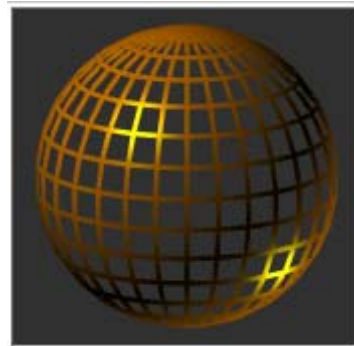

-  Render the scene. The orange renders with a thicker wire.

Tip: To depict an object turning to wireframe, animate the wire thickness.

- In the Shader Basic Parameters rollout, turn on 2-Sided. Now you can see the object's back side through the front wires.

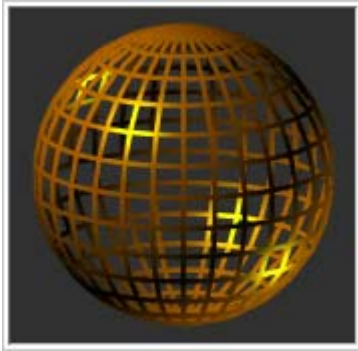

5. Turn off 2-Sided and Wire. The object turns solid again.

Add self-illumination:

Self-illumination makes an object look as though it's lit from within. Use Self-Illumination to save rendering overhead when you want to create lights that do not need to illuminate surfaces, such as running lights along the perimeter of a spaceship.

1. On the Blinn Basic Parameters rollout, set Self-Illumination of *myorange material* to **100** percent.

The dark areas of the orange brighten, making the orange look incandescent.

Note: If you see a black color swatch instead of the spinner, turn off Color.

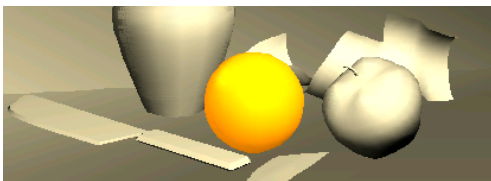

2. Right-click the Self-Illumination spinner to reset the value to **0**.
3. Save your file as **myorange.max**.

Understanding Ambient Color and Light

Ambient light is used to simulate indirect light, such as the atmospheric light that permeates outdoor scenes. It may also be used to simulate radiosity, which is the color that bounces off brightly colored objects.

Ambient color controls the color of objects in areas of shadow, whenever ambient light is present. Generally, you do not see any effect when you change the ambient color of a material, because ambient lighting is turned off by default.

To see the effect of ambient color in a scene, you must create an ambient light source. You can either create lights that are set to Ambient Only in order to create a localized effect, or use the Environment dialog to affect an entire scene.

Set up the lesson:

- Continue from the previous lesson.

Adjust the ambient light and color:

1. In the Material Editor, choose the *beige putty* material in the upper-right material sample.
2. Change the Ambient color of the *beige putty* material to a bright shade of purple.

The color of the scene does not change.

3. Choose Rendering > Environment. The Environment dialog appears.
4. Click the Ambient color swatch. In the Color Selector, change the Ambient color to a medium shade of gray. Then close the Color Selector and the Environment dialog.

The materials brighten in direct proportion to the brightness of the Ambient color. The *beige putty* objects in the scene turn purple.

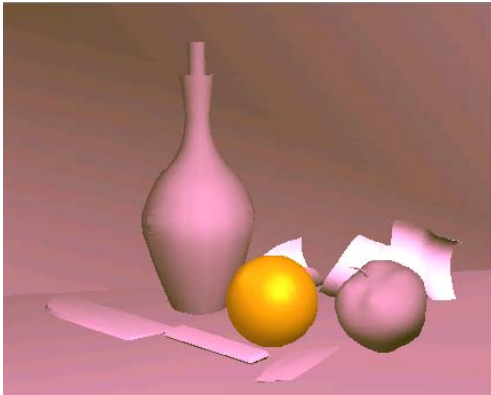

5. Activate the slot containing *myorange* material.
6. Click the lock button to the left of the Ambient and Diffuse colors to unlock them. Then change the Ambient color from orange to a bright green.

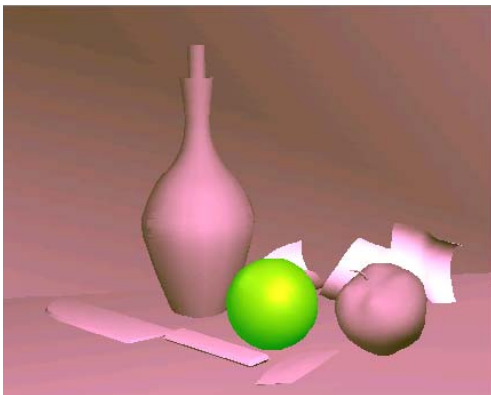
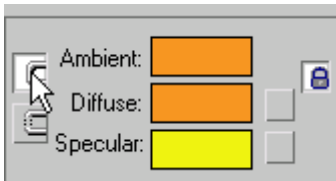

Watch the viewport and notice the orange turns bright green.

Creating Transparency

The Opacity parameter controls the transparency of a material. The default setting is 100 percent opaque. An Opacity value of 0 creates total transparency.

Set transparency:

1. Choose File > Reset.

Do not save your changes.

2. Press **M** to open the Material Editor.

3.  Click the Background button to the right of the sample spheres. A multicolored checker pattern appears in the active sample slot behind the sample sphere.

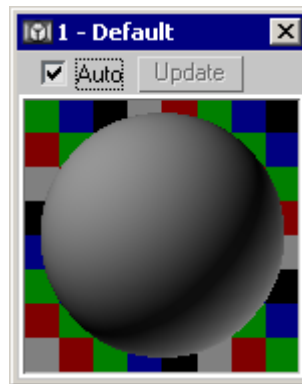

4. Double-click the sample material to open it in a separate window. Resize the window if you like.
5. In the Blinn Basic Parameters rollout change the Diffuse color to green. The Ambient color changes as well.

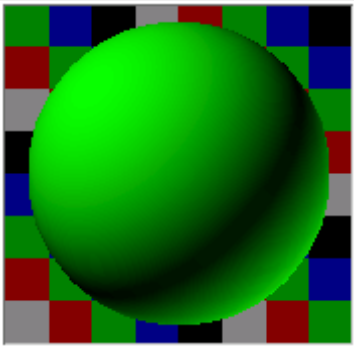

6. Set the Opacity value of the material to **50**.
The sample sphere becomes semi-transparent.

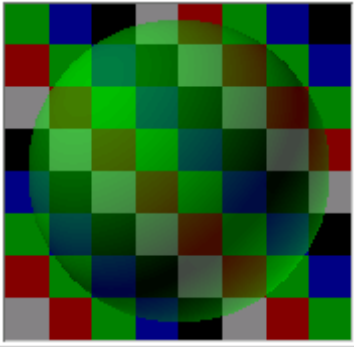

Opacity controls transparency.

7. Set the Specular Level to **100** and the Glossiness to **80**. Two small highlights appear on opposite sides of the sample sphere.

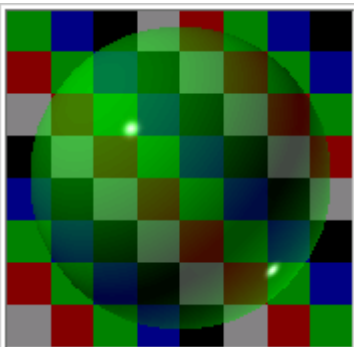

8. On the Shader Basic Parameters rollout, turn on **2-Sided**. Two more highlights appear on the sample sphere. These represent highlights inside the sphere.

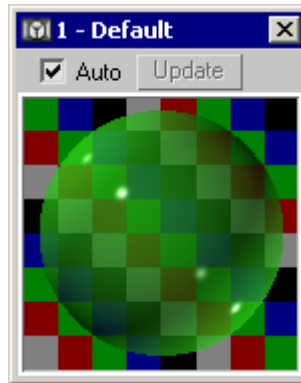

9. Open the Extended Parameters rollout.
10. Change the Falloff setting from **In** to **Out**.
11. In the Advanced Transparency group, set the Falloff Amt to **100**.

The sphere becomes more transparent towards the edges.

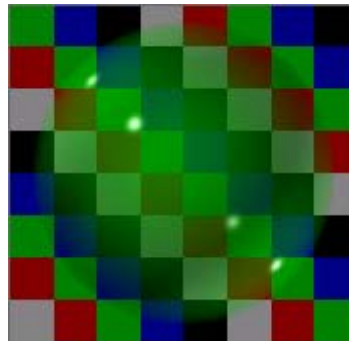

12. Change the Falloff setting from **Out** to **In**.

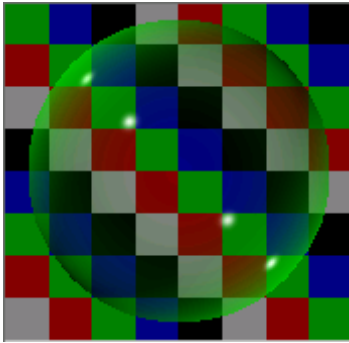

The opacity falls off towards the center of the sphere, revealing a nearly transparent center.

13. Change the Filter color to bright yellow.

The sample sphere takes on a ghostly look.

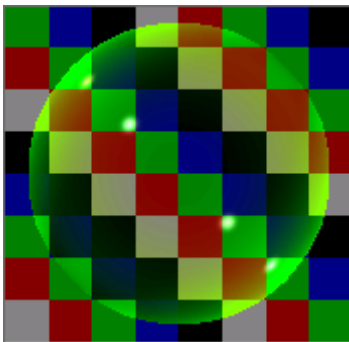

14. Change the Type to **Subtractive**, then **Additive**.

The areas of opacity turn dark like smoke, then light like clouds.

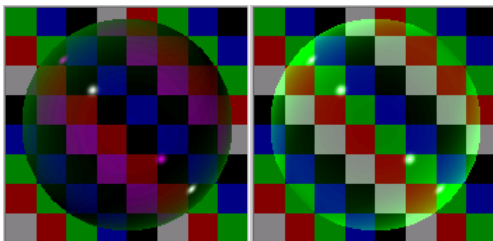

Understanding Shaders

For standard materials, a shader is an algorithm that tells 3ds Max how to calculate surface rendering. Each shader has a unique set of characteristics in order to serve a particular purpose. Some are named for what they do well, such as the Metal shader. Others are named for the person who developed them, such as the Blinn and Strauss shaders. The default shader in 3ds Max is the Blinn Shader.

Note: In addition to the shaders listed below, 3ds Max supports plug-in shader types.

The following list describes the shaders supplied with the software:

- **Anisotropic:** Used for brushed metal or hair. Creates a highlight that is stretched and angled, rather than the standard circular highlight.



- **Blinn:** Has the same features as the Phong shader, but its mathematics are more accurate. This is the default shader for Standard materials.



- **Metal:** Used for making metals.



- **Phong:** A classic shading method that was the first to enable specular highlights. Suitable for plastic surfaces.



- **MultiLayer:** Two anisotropic shaders in one. Used to make two different highlights with independent controls. Simulates materials such as a metal that is covered with a shiny coat of wax.

- **Strauss:** Suitable for metals. Allows you to control the degree of metallic characteristics of the material.



- **Oren-Nayar-Blinn:** An adaptation of the Blinn shader. It gives objects a porous, non-plastic appearance, and is suitable for surfaces like skin.

- **Translucent Shader:** Translucent shading is similar to Blinn shading, but it also lets you specify translucency. A translucent object allows light to pass through, and also scatters light within the object. You can use

translucency to simulate frosted and etched glass.

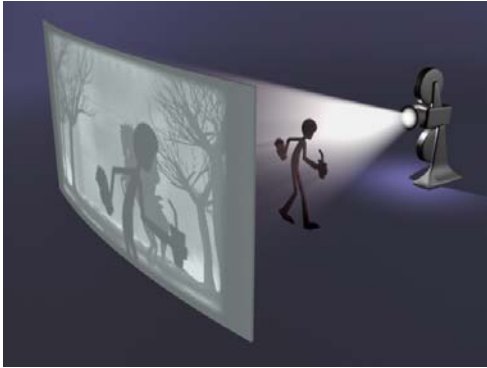

Comparing Shader Parameters

A shader is an algorithm that tells the program how to calculate surface rendering. Each shader has a unique set of characteristics in order to serve a particular purpose.

Compare the parameters of different shader types:

1. Open the Material Editor and click an available sample slot.
2. In the list on the Shader Basic Parameters rollout, change Blinn to Anisotropic.

The Blinn Basic Parameters rollout changes to the Anisotropic Basic Parameters rollout. Observe the differences in the available basic parameters.



3. Select each shader type from the list and compare its parameters with the others. Some parameters are shared in common, but each shader has its own unique combination of settings.

For more information on shader types, see the *User Reference*, including this topic: [Shader Basic Parameters Rollout](#).

Mapping and Mapping Coordinates

Adding images and textures to a material is one of the most important techniques for creating realistic effects. In this lesson, you learn how to add texture maps and bump maps to a material. You also learn how to position a map on the surface of an object by adjusting the mapping coordinates of the material.

- The files for this lesson can be found in the *tutorials/intro_to_materials* folder.

Make a texture map:

Suppose you want to make a realistic orange in your scene. The most direct way is to use a realistic image as the texture map in the diffuse component of a material. In other words, you replace the overall color with an overall texture. Here are the basic steps:

1. Buy an orange and photograph it.
2. Crop a portion of the photograph.
3. Digitize the cropped portion with a scanner or digital camera.
4. Load this image into your computer.
5. Apply the image as a diffuse map.



A cropped photograph of a real orange peel

Add a texture map to a material:

The digitized bitmap you are going to use is already being used by the orange material in the first sample slot. You can therefore browse for the bitmap from the Material Editor.

1. Open *intro_materials3.max*.

Note: If you see the [File Load: Units Mismatch dialog](#), choose the option Rescale The File Objects To The System Unit Scale.

2. Press **M** to open the Material Editor. Set the display to 5 x 3 Sample Windows, if it isn't already.
3. Click *myorangematerial*. It's the material in the lower-right corner of the Material Editor.
4. On the Blinn Basic Parameters rollout, click the map selector button to the right of the Diffuse color swatch to display the Material/Map Browser.
5. In the Browse From group, choose Material (Mtl) Editor.
6.  Click View Small Icons.

All the images that are currently loaded appear as small thumbnails.



7.  Click View Large Icons.

The thumbnails appear larger.

8. Click the image labeled *Diffuse Color: Orange (orangetex.jpg)* and click OK. On the Instance Or Copy dialog, choose Copy and click OK again.

The Material/Map Browser closes and the orange texture map appears in the material sample, but not in the viewport.

9.  To display the texture map in the viewport, click the Show Map In Viewport on the Material Editor toolbar.

The orange texture map appears in the viewport.

Note on Mapping Coordinates and Viewport Visibility

The orange map shows in the viewport because the orange object has mapping coordinates applied to it. Like other parametric objects in 3ds Max, the sphere of the orange generated its own mapping coordinates when created. This is not necessarily the case with editable meshes and many other types of geometry.

If the object in the scene didn't have mapping coordinates, the map wouldn't appear in the viewport, even if Show Map In Viewport is on. In that case, you can add a [UVW Map modifier](#) to the object to make the texture display.

If the texture map still doesn't display, you can move the gizmo of the UVW Map modifier, and experiment with the Offset, Tiling, and Angle parameters in the Coordinates rollout. This will be covered later in the tutorial.

Add a bump map:

The texture on the orange looks all right, but a real orange peel has a pitted surface. You can simulate this and add realism by using bump mapping. This won't show up in the viewport, but is visible when you render.

1. Select the orange in the viewport.
2. Click *myorangematerial* in the lower-right corner of the Material Editor.

3.  Click Go To Parent to access the material level.
4. Scroll down and open the Maps rollout.
5. Drag the *orangetex.jpg* map from Diffuse Color to Bump. Choose Copy and click OK.
6. Set the Bump Amount to **-100**.

There is no change in the viewport.

To really see the effect, you'll need to render the scene. It would also be a good idea to zoom in and see what's happening to the orange.

7. Activate the Front viewport. Select the orange, if it isn't already selected.
8. In the viewport navigation controls, use Arc Rotate Selected to rotate around the orange and get a good view (the viewport will switch to User type). Zoom so the orange fills up most of the viewport.
9. Render the Front viewport.

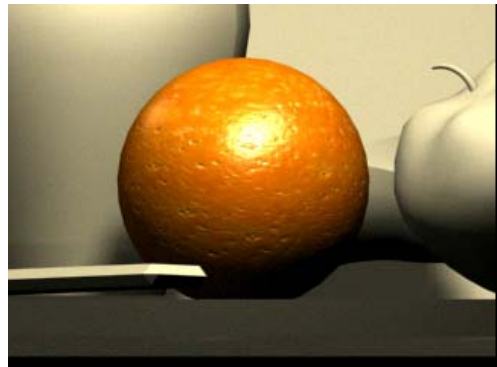

10. Drag the *orange* material in the first sample slot from the Material Editor to the Orange object in the viewport.

Nothing will change in the viewport, but this will let you use the experimental material for other purposes later in this exercise.

11. Press F so the viewport returns to Front view.

Use mapping coordinates and tiling:

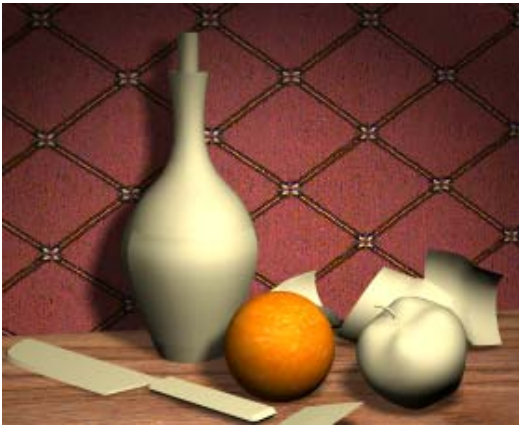

In this procedure, you use the concrete wall behind the objects to learn about mapping and tiling.

1. From the Material Editor, drag the *concrete* material (second row, fourth sphere) onto the wall object (named *L-Ext01*).

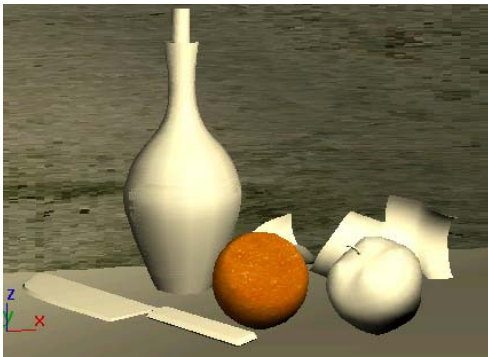

The concrete shows up in the camera viewport because the parametric object has generated its own mapping coordinates. But the concrete doesn't look quite right on the wall.

2. Select the wall object (*L-Ext01*), and then from the Modifiers menu > UV Coordinates submenu choose UVW Map.

The concrete changes appearance in the viewport.

3. Right-click in the Camera01 viewport to activate it.

4. In the Modify panel, scroll down to the Alignment group.

5. Change the Alignment from Z to Y to X.

Choose the one that looks correct; probably Y.

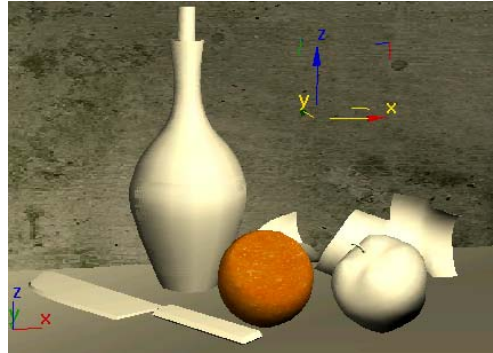

6. In the Modifier Stack, expand the UVW Mapping entry to see the Gizmo. Click the Gizmo entry to highlight it.



7. On the Main toolbar, turn on Select And Move. In the viewport, and drag the gizmo for the mapping modifier to move the map.

The concrete bitmap shifts behind the objects.

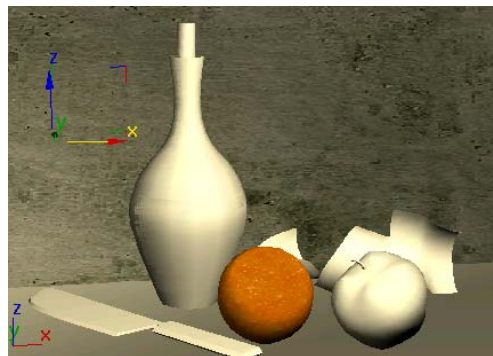

To control placement of texture maps:

- Move the UVW Mapping gizmo.

- Change the map's Offset values.

To control tiling of texture maps:

- Change the map's Tiling values.
- Change the UVW Mapping modifier's Tile values.

Create wallpaper with a tile pattern:

1. On the Modify panel, click Gizmo again to turn off sub-object selection.
2. In the Material Editor, choose the *concrete* material.
3. Change the name of the material to **background**.
4. On the Maps rollout, click the *concgren.jpg* map.

The rollouts change to the level of this map.

5. On the Bitmap Parameters rollout, select the Bitmap button, which contains the path to the *concgren.jpg* map. You'll replace this map with a tile pattern to create some wallpaper.
6. On the Select Bitmap Image File dialog, change the Files of Type to Targa Image File and choose *pat0039.tga*.

7.  Turn on Show Map in Viewport.

A diamond pattern appears on the wall.

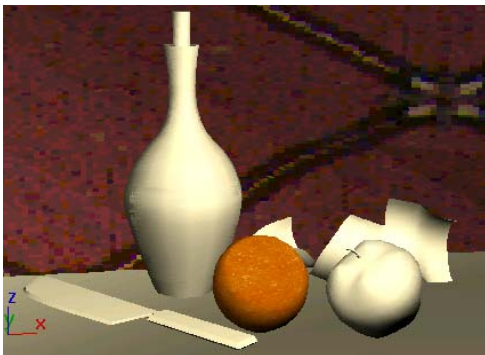

8. On the Coordinates rollout, set U Tiling and V Tiling to 4.

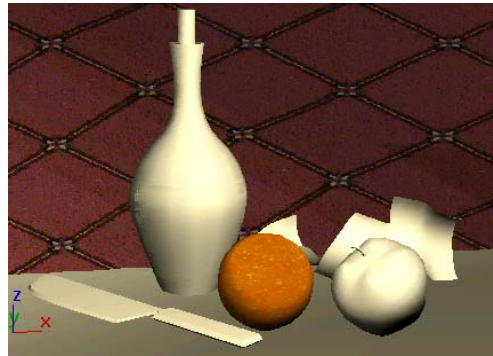

9. Change the U tiling by clicking the spinner until the tiling value is approximately 5.7.

This makes the pattern proportions more even.

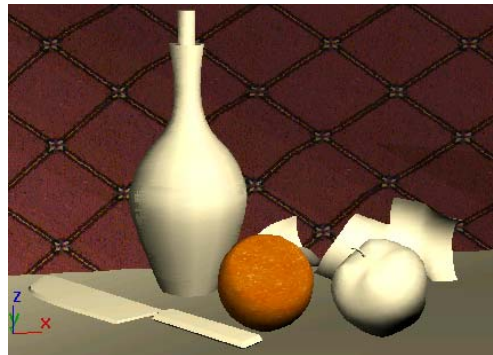

On some systems, the diamond pattern might be skewed in the Camera viewport. To correct this, right-click the Camera01 viewport label and choose Texture Correction.

10. See what happens when you add blurring and then render. Also try working with Blur Offset. Try setting the Coordinate rollout Blur parameter to 1.5 and Blur Offset to 0.1. When you're finished experimenting with Blur, return the Blur setting to 1.0.

Use opacity mapping to make a leaf:

You can use the leaf objects in the scene to experience a unique type of mapping. The leaf is created with a simple box mapped with a texture map and an opacity map.

The texture is a photo of a leaf.



The opacity map is a mask of white and black. The black becomes transparent when rendered.



1. On the toolbar, open the Named Selection Sets list and choose the set named *leavesandbase*.
2. Right-click in the active viewport and choose Hide Unselected.
The leaves and the base are now the only objects visible.
3. Hold down CTRL and select the base.
This deselects the plank base.
The objects are really just thin boxes that have Bend and Twist modifiers applied to them. They don't look anything like leaves right now.



4. Drag the leaf material from the Material Editor onto the leaves in the scene.
5. When the Assign Material dialog appears, choose Assign to Selection and click OK.

The *leaf* material is applied to all four leaves.

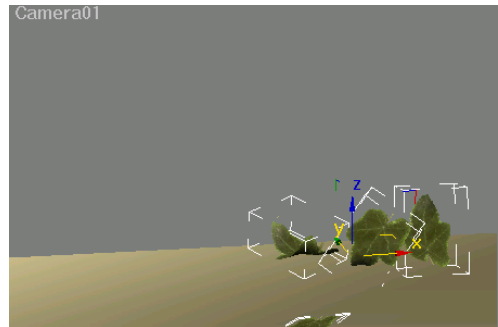

View the rendered leaves:

In this procedure, you zoom in without affecting your existing camera view.

- Render the Camera01 viewport.

The boxes seem to have been replaced by realistic leaves, and the opacity map and the shadow-casting spotlights combine to cast reasonable-looking shadows.

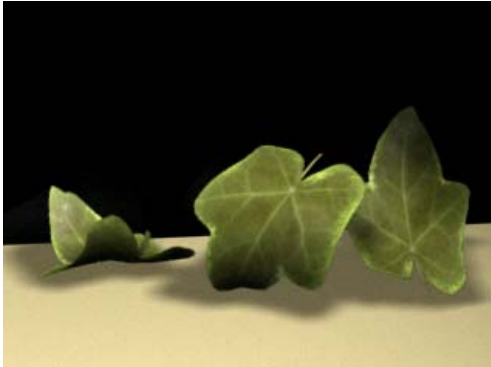



Use mapping coordinates:



Besides letting you see maps in the viewport, mapping coordinates give you control of how a texture is applied to the object. In this procedure, you'll add a UVW Map modifier to the bottle label. In the next procedure, you crop the texture.

Simple mapping is often solved by adding planar mapping coordinates and then working with the gizmo for adjustment. Let's see how this works on the label of the bottle.

1. Right-click in the active viewport, and choose Unhide All. All the objects in the scene reappear.

2. Select the orange, right-click, and choose Hide Selection in the Display quadrant.
3. Press **H** and select *label01*.
4. Right-click in the Front viewport to activate it, without affecting the selection of the label. Then press **G** to turn off the grid.
5.  Open the Modify panel and add a UVW Map modifier to the label.
6.  Region Zoom into the Front viewport so you have a better view of *label01*.
7. Change the Front viewport display to Smooth + Highlights.
8. In the Parameters rollout > Alignment group, turn on Region Fit and draw a box slightly smaller than the label.

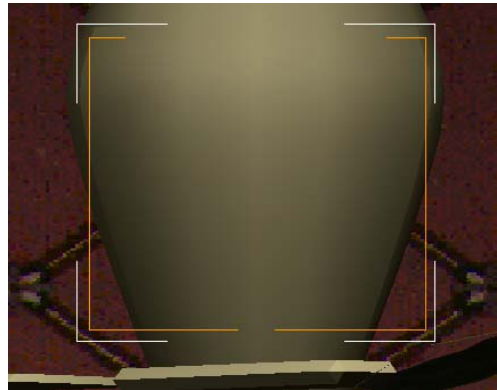

Region Fit lets you draw the gizmo to the size you want.

9. In the Material Editor, click the *label* material.
10.  Use Assign Material To Selection to apply the material onto the label.



11. Save the scene as **mymaterials3.max**.

Crop the texture:

The Gluggo texture map doesn't really fit the label properly, so you'll fix it by using the cropping features of the Material Editor.

1. In the Material Editor > Maps rollout, click the Diffuse map button labeled *gluggo.jpg*.
2. In the Bitmap Parameters > Cropping/Placement group, be sure Crop is chosen. Click View Image.

A Specify Cropping/Placement window is displayed showing the label bitmap.

3. Crop the Gluggo label by dragging the handles on the corners and sides of the selection region. Crop so the dark edge at the top is outside the selection region. Close the window.

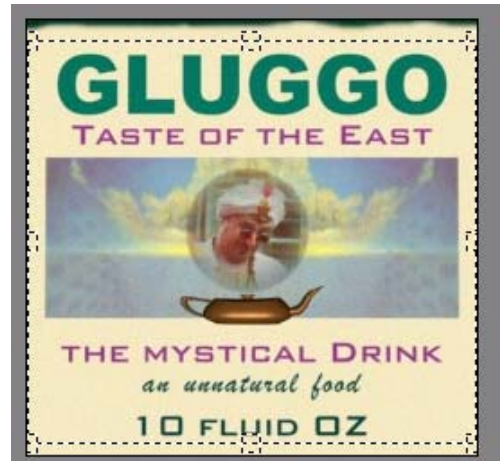

4. Turn on Apply, if it isn't on already.

The dark edge no longer appears on the label in the viewport. Adjust the length and width of the modifier so that the map fits the label better.



Add a sticker on the label:

- Assume a scenario in which the Gluggo brand has been purchased by GulpcO. It's your job to redo the image with the new Gluggo-GulpcO label. In the following procedures, you'll put a GulpcO sticker onto the label to add the new company name. As you do this, you'll learn about multiple channels and UVW coordinates.

GULPCO

Set up the mapping modifier:

1. Press **H** and select *label01*, if it's not already selected.
2. Right-click in the active viewport and choose Hide Unselected.
Everything disappears except for the label.
3. In the Front viewport, zoom in on the label.
4. Go to the Modify Panel and check the modifier stack.
The label already has a UVW Mapping modifier applied to it.
5. Right-click the UVW Mapping modifier and choose Rename.
6. Rename the UVW Mapping modifier to **Gluggo label**.
7. Scroll down to the Channel group and change the map channel to **3**.
The label changes orientation in the viewport.

Set up the label material:

1. In the Material Editor, click the *label* material if it's not already active.
2. Click the map button next to the Diffuse color swatch to open the Bitmap map rollouts, if necessary.
3. In the Coordinates rollout, change the Map Channel for the label map to **3**.
Now the label map will use the mapping from the *Gluggo label* modifier, because they both use the same map channel.

Select faces:

Here, you'll select the faces where the Gulpco sticker will go.

1. In the Front viewport, change the display to Edged Faces (press **F4**).
2. In the modifier stack, click Editable Mesh.

3.  Turn on Polygon selection.
4. Select the three rows of faces in the middle of the label.

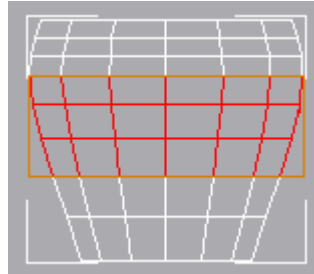

The label middle faces selected

5. Scroll down to the Surface Properties rollout > Material group and change Set ID to **2** for these faces.
6. Exit the Polygon sub-object level.
This is an important step. If you don't turn off Polygon selection, what follows will not work as expected.
7. With the Editable Mesh still selected, add a second UVW Map modifier.

The new UVW Mapping modifier is inserted in the stack between the *Gluggo label* modifier and the Editable Mesh. It will supply the mapping coordinates for the Gulpco sticker.



8. Right-click the new UVW Mapping modifier and rename it **Sticker**.
9. Scroll down to the Channel group and set Map Channel to **2**.

Convert to a multi/sub-object material:

You'll use the original label as a base for the new label.

1.  On the Material Editor toolbar, click Go To Parent.
2. Choose the material *label* and click the Standard button.
3. In the Material/Map browser, make sure the Browse From group is set to New.
4. Double-click the Multi/Sub-Object entry. In the Replace Material dialog, make sure Keep Old Material As Sub-material is chosen, and then click OK.
5. In the Multi/Sub-Object Basic Parameters rollout, click Set Number. Change Number Of Materials to 2 and click OK.
6. In the Name field next to the label material, type **Gluggo**.
7. In the Name field next to the second material, type **GulpcO**.

Add a map to the second sub-material:

1. Click the second material.
2. Click the map button to the right of the Diffuse color swatch.
3. On the Material/Map Browser dialog, make sure Browse From is set to New, and then double-click the Bitmap list entry. The Select Bitmap Image File dialog opens.
4. Navigate to the *tutorials\intro_to_materials* directory and choose *gulpcO.jpg*.
5. On the Coordinates rollout, set the Map Channel to 2.
6.  Click Show Map In Viewport. The second map appears in the viewport, layered on top of the first.



7. Adjust the Offset and Tiling settings for the *GulpcO* map until it's centered on the bottle.



8. Repeat the process for the *Gluggo* material so that the map is centered behind the GulpcO label.
9. Save your work again as **mymaterials3.max**.

Creating Multi/Sub-Object Materials

When you want to apply two or more materials to an object, you use a Multi/Sub-object material. This is a material type that can contain up to 1,000 different materials, each identified by a unique

number called a material ID. By assigning different material IDs to discrete selections of faces, you control where each material will appear when the parent Multi/Sub-Object material is applied to the object.

- The files for this lesson can be found in the *tutorials/intro_to_materials* folder.

In this exercise, you'll create the material automatically by dragging and dropping onto sub-object selections.

Create Multi/Sub-object materials using drag and drop:

1. Open *intro_materials4.max*.

Note: If you see the [File Load: Units Mismatch dialog](#), choose the option Rescale The File Objects To The System Unit Scale.

2. Right-click the Camera viewport label and change the viewport display mode to Wireframe.

The viewport now displays all the geometry in wireframe.

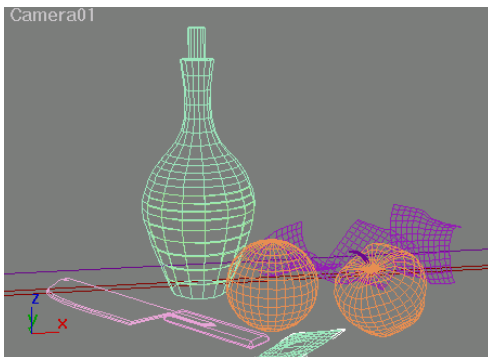

3. On the menu bar, choose Views > Shade Selected.
4. Select the bottle in the viewport.

The bottle alone is shaded. At the top of the Modify panel, the object name *bottle with label*

is displayed in boldface to indicate that this is a group.

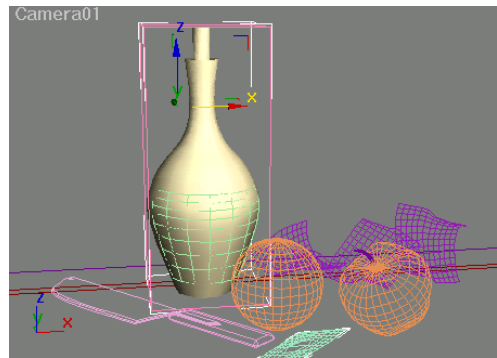

5. On the menu bar, choose Group > Open.

The grouping is temporarily suspended so you can manipulate the members of the group individually.

6. Press **H** and select the *label01* by name from the selection list.

The label becomes shaded.

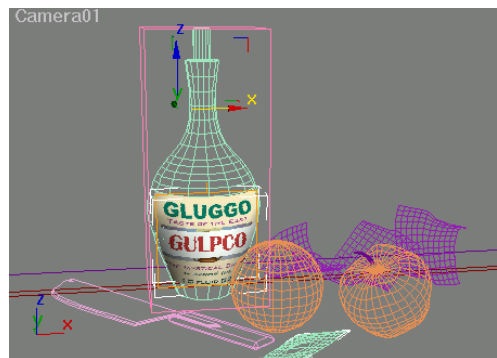

7. Right-click in the viewport and choose Hide Selection.

The label is hidden from view. Now you can work just with the bottle.

8. Select the bottle again.

The name of the object is *bottlewithcork*.

Assign material IDs:

In order to assign material ID numbers to different parts of an object you must first make a sub-object selection of faces or polygons. Since the bottle is already an Editable Poly object, sub-object selection tools are available in the Modify panel.

1.  On the Modify panel, access the Polygon sub-object level by clicking the Polygon selection icon.
2. Right-click the Camera viewport label, and turn on Edged Faces (or press **F4**).
3. In the Camera viewport, select the polygons used for the cork by dragging a region around the top of the cork and down to (but not including) the top of the glass.

The selected polygons turn red in the viewport.

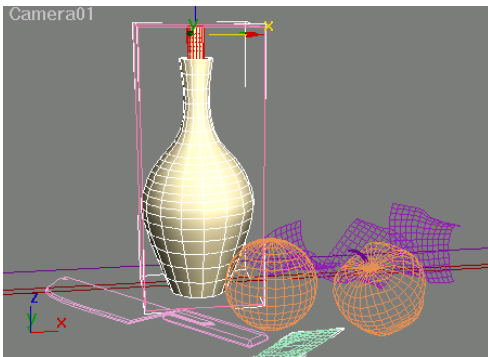

If the selected polygons don't turn red, right-click the Camera viewport label and choose Configure. In the Viewport Configuration dialog > Rendering Method tab > Rendering Options group, turn on Shade Selected Faces.

4. In the Material Editor, click an unused material and name it **cork**.
5. From the Material Editor, drag *cork* to the cork on the bottle.
6. On the menu bar, choose Edit > Select Invert.

Everything except the cork is now selected for the glass.

7. Drag the *green bottle* material from the Material editor to the selection set of faces.

The bottle turns bright green.

8.  Turn off Polygon selection.

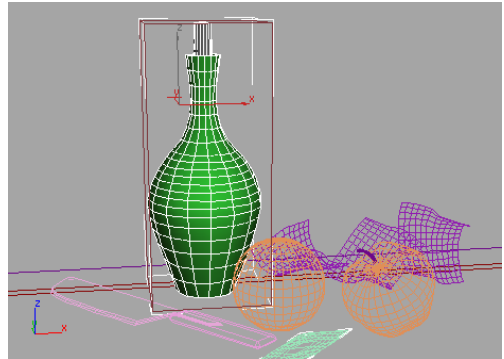

Add the new material to the Material Editor:

3ds Max has automatically created a new Multi/Sub-Object material in the scene. However, if you want to work on the material, you will need to load it into the Material Editor.

1. In the Material Editor, click an unused sample slot.
2.  Click Pick Material From Object.
3. Click the cork with the eyedropper cursor.

The multi/sub-object material is transferred to the Material Editor. Both materials are displayed on the same sphere.

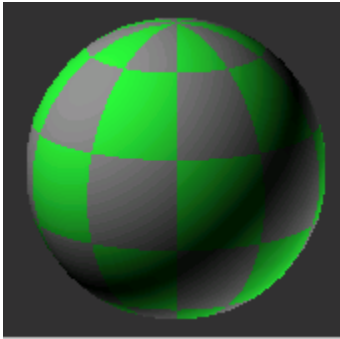

4. Name this material **mybottle**.
5. On the Multi/Sub-Object Material Parameter rollout, click the material *cork*.
The Material Editor moves to the level of that material and displays its parameters. The sample sphere displays only the single material now.
6. Expand the Maps rollout and click the None label next to the Bump map component.
7. Change Browse From to New, if it isn't already set.
8. On the Materials/Map Browser, pick Dent.



9. Name the bump component of this material **bumpy dents**.
10. On the Dent Parameters rollout, set Size to 22 and Strength to 5.
11. Set Color #1 to a pale brown and Color #2 to a medium brown.

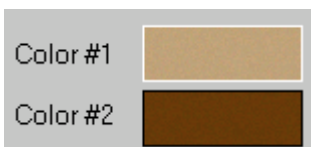

12.  Click the Go To Parent button.

13. Drag the *bumpy dents* map from the Bump component to the Diffuse Color component and choose Copy.
14. Click the new Dent map to go to the Dent Parameters level of the Diffuse Color and name this map **cork dents**.
15. Set one of the viewports to Front and zoom in on the cork.
16. Render to see what the dents look like on the cork.



17. If you like, change the colors in the *cork dents* map in the Diffuse component and render again.
18. Save your file as **mybottlematerials.max**.

Using Raytrace Materials and Maps

Raytrace materials are perfect for reflective materials like shiny metal and glass.

- The files for this lesson can be found in the *tutorials/intro_to_materials* folder.

Set up the lesson:

1. Continue from the previous exercise or load *bottlematerials.max*.

2. Change the Camera viewport back to Smooth + Highlights.
3. Turn off Views > Shade Selected, if it's currently turned on.

Make green glass using a raytrace material:

1. Open the Material Editor and access the *green bottle* material within the multi/sub-object material.
2. Change the material type from Standard to Raytrace.

The bottle changes to a gray color in the viewport.

3. In the Material Editor, make the Diffuse color a rich forest green.

The bottle changes to a green color in the viewport.

4. Click the Transparency color swatch. Change the color to light gray by setting Value to **119**.
5. Set the Reflect color swatch to a darker gray: Value=**100**. Close the Color Selector dialog.

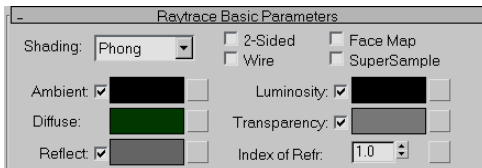

6. Drag the *wood countertop* material to the counter (*base*) object.
7. Render the Camera01 viewport.

The bottle shows the reflections of adjacent objects.



Raytrace reflections in the scene:



There are several ways to make objects appear reflective. You choose a method of creating reflection based on the main source of an object's color and the quality you want to achieve. For objects that derive their color primarily by reflection, such as polished metal or glass, you will probably want to use a raytrace material. If an object has a strong local color or texture as part of

its material, you might add a reflection map to the Reflection map component instead.

1. Press **H** and choose *[knife]*. The knife and its handle are grouped together.
2. Choose Group > Open.
3. Select the knife blade in the viewport.
4. From the Material Editor, drag the *knife blade* material to the knife blade (*Line02*).
This is another Raytrace material. It's a lot like the Raytrace green glass material except that it's not transparent.
5. Drag the *knife handle* material to the knife handle.
6. Click the *wood countertop* material. On the Maps rollout, click the None button of the Reflection map component.
7. In the Material\Map Browser, double-click the Raytrace map type. In this case you're adding a raytrace only to the Reflection component.
8. Name the Reflection component **counter reflection**.
9.  Click Go to Parent. On the Maps rollout, set the Reflection amount to **44** and the Diffuse Color amount to **90**. This will keep the reflection from overpowering the wood texture.
10. Render the Camera01 viewport, and examine the reflections in the knife blade and countertop.



11. Save your file as **mymaterials4.max**.

Texturing the Chessboard

In *Modeling a Chess Set* (page 1–21), you learned how to create the pieces for a chess set. Chess pieces want to live on a chessboard. In this tutorial, you'll construct a chessboard that has a wood-grained, checkerboard pattern. You'll also add shininess and reflection to the chessboard.

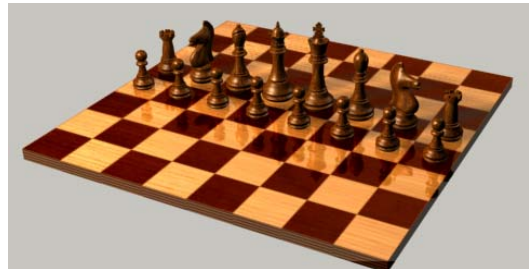



- The files for this lesson can be found in the *tutorials/intro_to_materials* folder.

Set up the lesson:

- Load the file *tut_knight.max*.

Create the chessboard:

1.   On the Create panel, click the Geometry button. Make sure Standard Primitives is chosen in the drop-down list.

- Click the Box button.





- If 2D Snap is on, turn it off.
 - In the Top viewport, drag to set the initial length and width of the box, then release the mouse and drag downward to set an initial height. Click to finish.
- Don't worry about the initial dimensions: you will change them soon.
- Rename the box **chessboard**.
 - In the box's Parameters rollout, set the Length and Width to both equal **32cm**, and set Height equal to **-1cm**.

Tip: Because the board is bigger than the chess pieces, you might need to zoom viewports and move either object before you can comfortably see both of them together.

- Use the Move tool to position the box at the world origin: **0,0,0**.

Create the squares:



- Activate the Perspective viewport and click the Zoom Extents button.
-  Click the Field Of View button and zoom in so the chessboard fills the viewport.
-  On the toolbar, open the Material Editor by clicking the Material Editor button or use the **M** keyboard shortcut.



- Click the first sample sphere and click the map button just to the right of the Diffuse color swatch.

The Material/Map Browser appears.

- In the Material/Map Browser, double-click Checker.

3ds Max has a built-in checker pattern, which makes your work easier. The active sample slot now shows a sphere with the checker pattern.



-   In the Material Editor, click Assign Material To Selection, and then click Show Map In Viewport.

This lets you see the map in shaded viewports. (The viewport display of maps is only an approximate.)

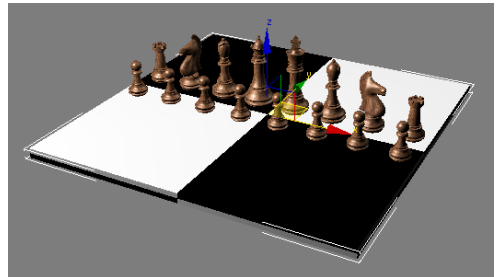

The default checker pattern is two by two, but a chessboard needs eight squares in each direction.

Note: If the checker pattern looks slightly skewed, right-click the Perspective viewport label and turn on Texture Correction.

- On the Coordinates rollout, set both the U and V Tiling values to **4.0**.

Now the board has the right number of squares.

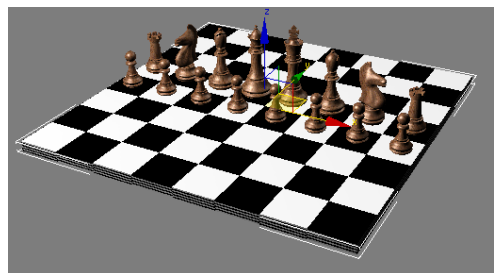

If you render the Perspective viewport, you see that the checker pattern is more refined than the shaded viewport shows.

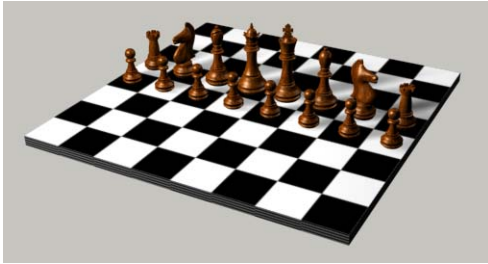

Note: Because the chessboard is made out of a box, the checker pattern is also applied to the sides. Since the chessboard is so thin, the pattern on the sides isn't obvious.

Give the checker pattern a wood texture:

1.  Open the Utilities panel and click Asset Browser.

The Asset Browser appears. Click OK to the copyright advisory it displays.

2. The Asset Browser is a large dialog. Move and resize it so you can see both it and the Material Editor.
3. Use the navigation tree at the left of the Asset Browser window to locate the *tutorials/intro_to_materials* folder.
4. In the Material Editor, make sure the Checker map's Checker Parameters rollout is visible.
5. In the Asset Browser, locate the file *Oak1.tga*. Drag the *Oak1.tga* thumbnail to the Color #1 map button on the Checker Parameters rollout. Then drag the *Walnut3.tga* thumbnail to the Color #2 map button.
6. Close the Asset Browser.

Now if you render the chessboard, it has a contrasting wood pattern.

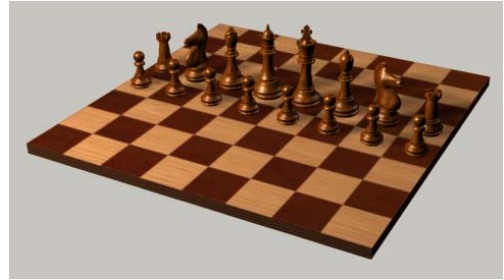

7. Save the scene as **mychessboard.max**.

Add polish to the chessboard:

1.  In the Material Editor, click the Go To Parent button.
2. Open the Maps rollout.
3. Click the map button for the Reflection map component.

The Material/Map Browser opens.

4. Double-click the Flat Mirror map.
5. Render the scene.

The pieces are reflected in the chessboard, but the wood grain is washed out.

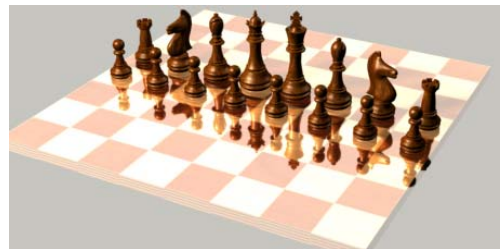

6.  Click the Go To Parent button and, on the Maps rollout, change the Reflection Amount to **30**.

The wood grain is not as washed out as before but still looks faded.



7. On the Maps rollout, click the Checker map in the Diffuse Color component.
8. In the Checker Parameters rollout, click the Color #1 map and open the Output rollout.
9. Set the Output Amount to 1.5.
10.  Click the Go Forward To Sibling button and make the same change to the Output Amount of the Color #2 map.
11. Render the scene.

The wood grain looks much warmer and more realistic.

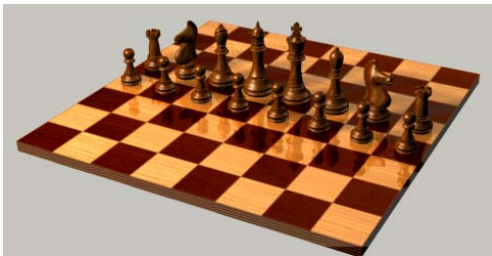

12. Save the scene as **mychessboard01.max**.

Using Displacement Mapping with Surface Properties

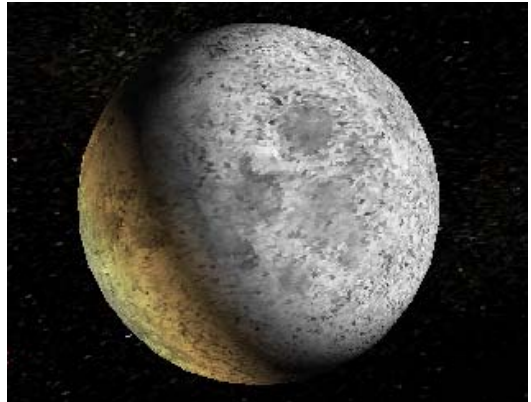

In this lesson, you make a moon with a detailed surface using displacement mapping combined with Surface properties.

- Bitmaps for this lesson can be found in the *tutorials/intro_to_materials* folder.

Create a moon:

1. Reset 3ds Max.
2. In the Perspective viewport, create a sphere that fills the viewport.
3. On the Create panel, set the Radius to 100. Name the sphere **Earth's Moon**.
4.  Click Zoom Extents All to zoom out in all four viewports.

Set up lights and cameras:

1.  On the Create panel, open the Camera sub-panel and click Target.
2. In the Perspective viewport, create a target camera by dragging anywhere in the scene.
3. Press **CTRL+C** to match the camera to the Perspective viewport. Then press **C** to change the viewport to the camera view.

4.  Click Zoom Extents All. In the Top viewport, you see the camera is facing the moon at about a 45 degree angle.

Note: Your sphere might be a different color than the one shown here.

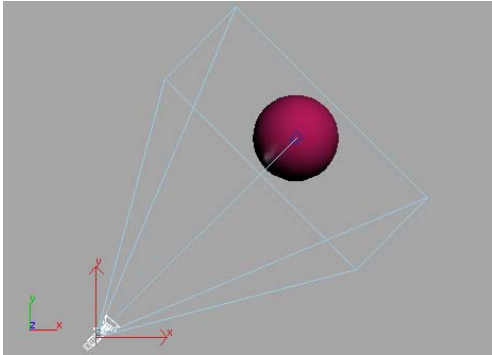

5.  On the Create panel, open the Lights sub-panel and click Omni.
6. In the Top viewport, create an omni light by clicking at the bottom of the viewport. Name this light **main light**.

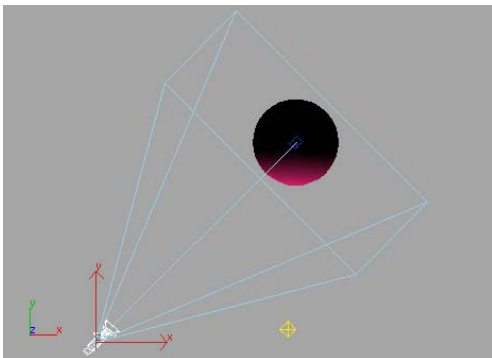

7. On the Modify panel, turn on Shadows and set Multiplier to 1.2.
8. In the Top viewport, create another omni light by clicking near the top left of the viewport. Name this light **fill light**.

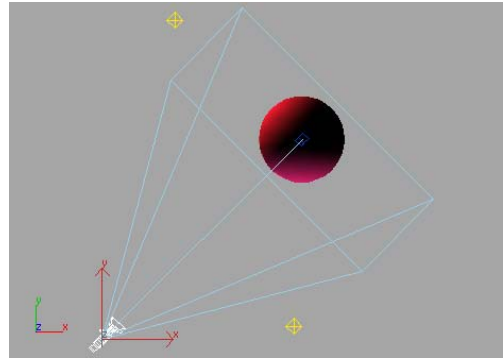

9. On the Modify panel, turn on Shadows and set Multiplier to 1.5. Then change the color of the fill light to orange. This adds some warmth to the image.
10. Right-click in the Camera viewport to activate it. Then press **F9** to render the scene.



In the rendered image, the highlights on the moon appear very bright, and the edges of the moon need more detail. You will fix both problems using mapping.

Map the moon:

1. Press **M** to open the Material Editor.
2. Click a material sample slot. Name the material **Earth's Moon**.
3. Choose the Oren-Nayar-Blinn shader from the drop-down list on the Shader Basic Parameters

rollout. The highlights of the material darken, giving the sample sphere a softer look.

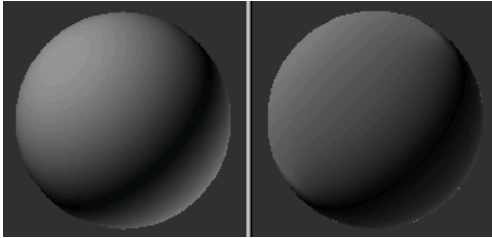

Comparing the Blinn (l) and Oren-Nayar-Blinn (r) shaders

4. Click the Diffuse map button; it's the blank gray button to the right of the Diffuse color swatch. In the Material/Map Browser, choose Bitmap and click OK.
5. Use the Select Bitmap Image File dialog to open *moon.jpg*. The moon map appears on the sample sphere.
6.  Click Show Map In Viewport, and then drag the material onto the sphere.
7. Press **F9** to do a test render.



8.  In the Material Editor, click Go To Parent.
9. Drag from the Diffuse map button to the Diffuse Level map button, in the Advanced Diffuse group. Choose Instance and click OK.
10. Press **F9** to see the result.



The dark areas of the map look even darker.

Displace the surface with a map:

Displacement mapping uses an image or algorithm to alter the geometry of an object. Unlike bump mapping, it actually changes the mesh, so you can see the texture on the edges of an object. Ordinarily this isn't visible until you render, although you can see it in the viewports with the Disp Approx modifier. This modifier is not covered in this tutorial.

1. Open the Maps rollout. Pull down the bottom edge of the Material Editor so that you can see the entire rollout, if necessary.
2. Drag the *moon.jpg* map from the Diffuse Level map component to the Displacement map component. Choose Copy and click OK.

The button next to Displacement is now labeled "Map#2 (Moon.jpg)."

3. Set Displacement amount to **-20**.
4. Select the sphere. Right-click the sphere and choose Convert To Editable Poly.
5. On the Modify panel, scroll down to the Subdivision Displacement rollout and open it.
6. In the Subdivision Displacement rollout, turn on Subdivision Displacement and click Low. This prevents the surface mesh from becoming too complex.

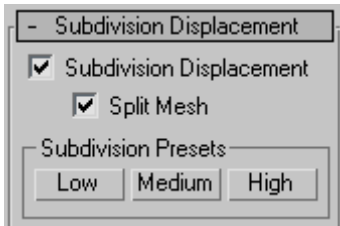

7. Press **F9** to render. The surface of the moon appears bumpy.



8. On Material Editor > Maps rollout, increase the Displacement amount to **-50**.
9. Press **F9** to render. The surface of the moon appears even bumpier.

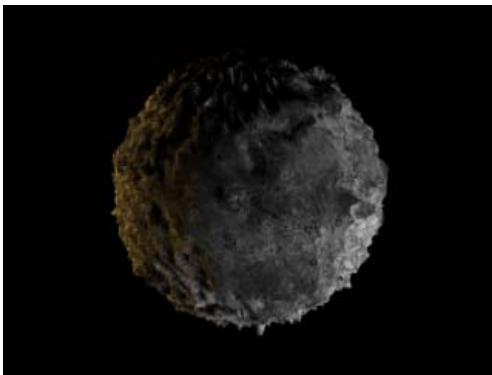



Displacing the surface of the moon

Control the areas of displacement:

This procedure shows you how to control the surface displacement so that it accentuates the areas of moderate displacement.

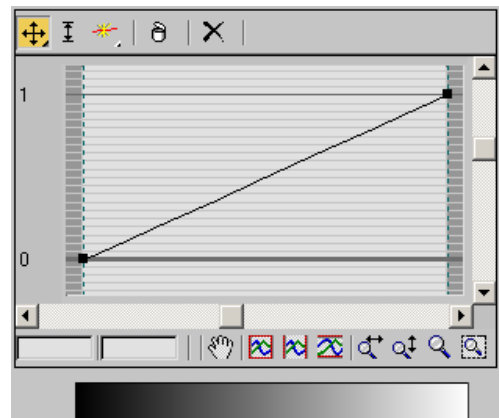
1. On the Maps rollout of the Material Editor, click the Displacement map button labeled "Map#2 (moon.jpg)."
2. On the Bitmap Parameters rollout, click View Image. The close grayscale values that you see in the map limit the amount of surface variation.
3. Close the viewer window and scroll down to the Output rollout.
4. Open the Output rollout and turn on Enable Color Map. Scroll to the bottom so you can see both the graph and the gradient bar.



5. Drag the point on the right downward so the line is horizontal.
The gradient bar and the sample slot turn black.
6.  Click Add Point. Then click to add two points to the curve at about one-third intervals along its length.
7.  Click Move. Select the two points that you just created and move them upward to form a trapezoidal graph.

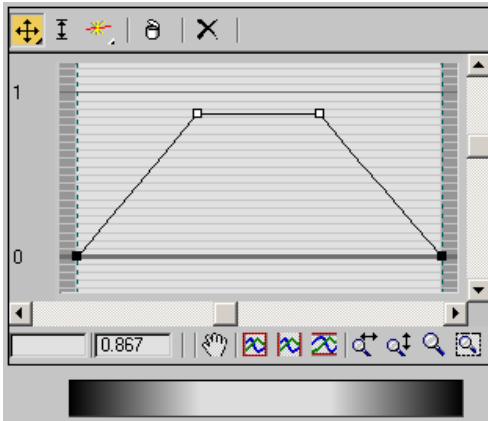

8. Press **F9**. The bumpiness increases across the middle values of the map.

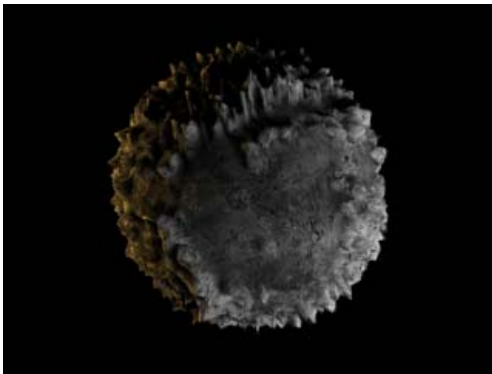

The moon with mountains

9.  Click Go to Parent. Change the Displacement to **20** and press **F9**. You now have a moon with craters.



Craters on the moon

10. Save your file as **mymoon.max**.

Adding Stars to the Sky

Vincent van Gogh is not the only one who gets to have fun painting the night sky. In this lesson you'll create your own starry night using a Noise map in the environment background.

- The files for this lesson can be found in the *tutorials/intro_to_materials* folder.

Apply a Noise material:

1. Open *moon.max*.
2. Press **8** on the keyboard to open the Environment dialog.
3. Click the Environment Map button.
4. In the Material/Map Browser, choose Noise and then OK. The Noise map appears in the Environment map component.
5. Open the Material Editor.
6. Drag the Noise map from the Environment dialog to an unused sample sphere. Choose Instance and click OK.

The sample sphere disappears and is replaced with the Noise map. The map is displayed as a square, since this is a map, not a material.

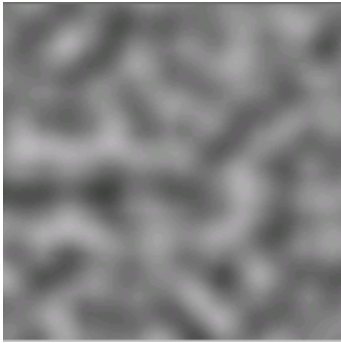

7. Scroll down to the Noise Parameters rollout and set the Noise Size to **0.2**.
8. In the Noise Threshold settings, set the low threshold to **0.6** and the high threshold to **0.7**. This narrows the range between white and black so the noise will display as dots or pinpoints.
9. Activate the Camera viewport and press **F9** render the scene. Hundreds of stars appear in the sky.

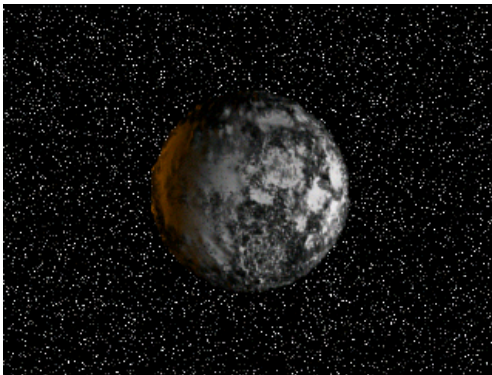

Stars created with Noise material

10. Reduce the number of stars by increasing the low threshold to **0.65**. Then tone down the brightness of the stars by changing the white Noise color to pale gray.
11. Render the scene again. The stars fade into the background.

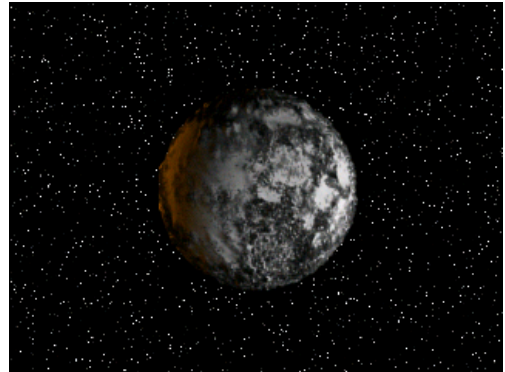

After adjusting the Noise material

Create a nebula field:

To add drama, create a nebula field by mapping the black areas of the Noise material with a Gradient Ramp.

1. On the Noise Parameters rollout, click the Color #1 map button.
2. Choose Gradient Ramp from the Material Map Browser and then OK.
3. The Material Editor moves down a level in the material tree. The sample sphere is replaced by a grayscale gradient. Scroll to the Gradient Ramp Parameters rollout. The Gradient ramp has three flags: one on the right, one in the middle, and one on the left.

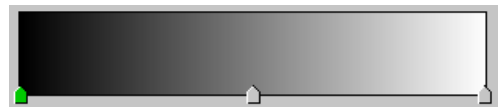

4. Double-click the flag on the right to display the color selector. Change the color to black.
5. Without closing the color selector, click the middle flag and change it to blue. Then close the color selector.
6. In the Noise group, set Amount to **1.0**. Choose the **Fractal** option and set Size to **9.0**.

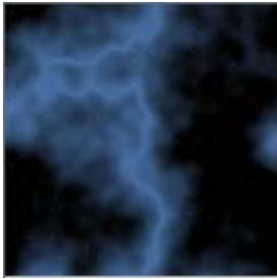

7. Render the scene. A diffuse blue nebula appears in the sky.

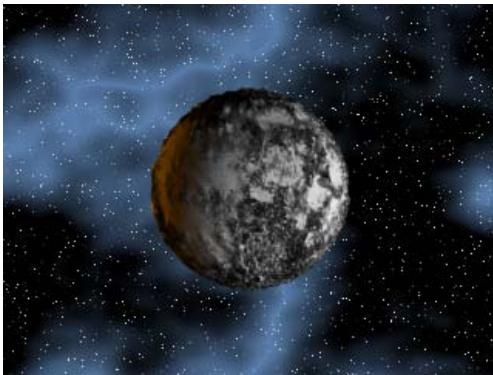

Add a streak to the nebula field:

1. Click twice near the center of the gradient, on either side of the middle flag. Two more flags appear. (If you make too many flags, right-click a flag and choose Delete.)
2. Double-click the middle flag and change its color to a lighter blue.



3. Set the Noise Levels parameter to **6** to add more details to the streak.
4. Render the scene.





Nebula background with a streak

5. Experiment with the gradient color, type and noise parameters until you master the effect.
6. Save your work as **mymoonandstars.max**.

Create a starry sky with a large sphere:

Another way to make stars is to create a large sphere, invert its normals, and then apply a starfield bitmap to it.

1. Using the keyboard entry method, create a very large sphere with a radius of about **1200**. (If you're not familiar with this method, open the Create panel and click Sphere. Open the Keyboard Entry rollout and set Radius to **1200**. Then click Create.)
2. Name the sphere **skydome**.
3. Open the Modifier panel. From the Modifier drop-down list, choose Object Space Modifiers > Normal.
4. In the Parameters rollout, turn on Flip Normals, if it is not already on.
5. Open the Material Editor and click an unused sample slot. Name the material **starry sky**.

6. Click the Diffuse map button. In the Material/Map Browser, choose Bitmap and click OK.
7. In the Select Bitmap Image File dialog, choose *stars10.jpg* and click OK. This is a large and detailed map, so it may take a moment to load.
Note: You'll find this bitmap in the *tutorials/space* folder.
8.  Turn on Show Map In Viewport.
9.  Click Go to Parent. On the Blinn Basic Parameters rollout, set Self-Illumination to **100**.
10. Drag the material onto the *skydome* object and press **F9** to render the scene. The stars from the map appear in the sky, replacing the environment background map.

Brighten the stars:

1. Open the Maps rollout and click the Diffuse Color map.
2. Open the Output rollout and set RGB Level to **2.0**. To filter out the dimmer stars, set the Output Amount to **1.2**.
3. Press **F9** to render the scene.

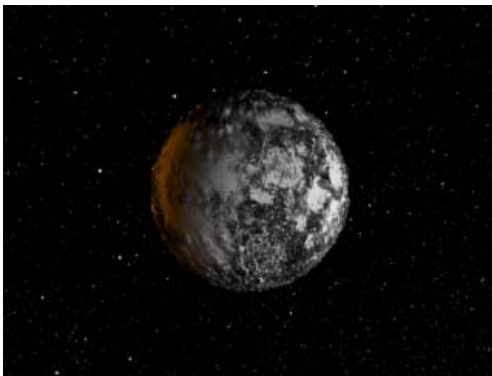

Save your work:

- Save your work as **mymoonandstars2.max**.

Creating a Skin Material

Human skin is difficult to simulate in computer graphics because it reflects light from a short distance beneath the surface, rather than directly at the surface. In this lesson, you'll learn how to use the Shellac material to create a material that closely resembles skin.

The files for this lesson can be found in the *tutorials/intro_to_materials* folder.

Set up the lesson:

- Open the scene file *skin_material_start.max*.

Create the skin material:

1.  Open the Material Editor, and then click the third sample slot on the top row.

This material is already applied to the head.

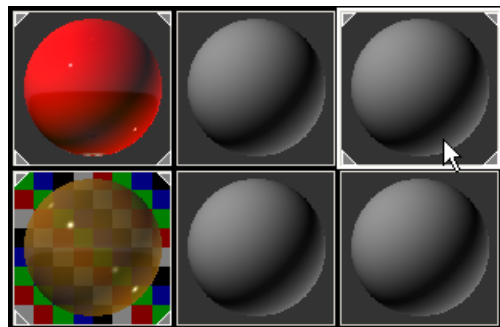

2. Click the Standard button, just above the rollouts, and then in the Material/Map Browser, double-click Shellac.

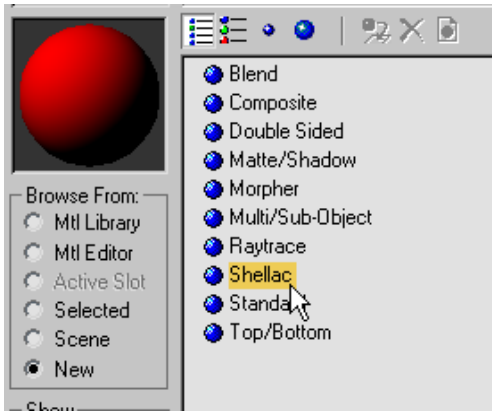

Shellac is a special material that superimposes one material over another so that you can see through the upper material to the lower one. This capability is well suited to simulating human skin.

3. On the Replace Material dialog that displays, click OK to keep the old material as a sub-material.

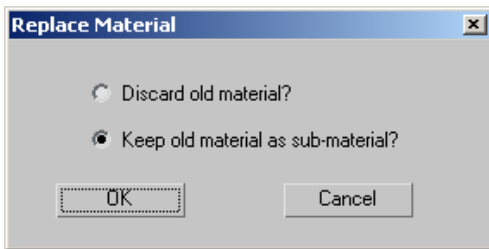

4. Name the material **Skin**.

Choose a map for the base skin material:

1. On the Shellac Basic Parameters rollout, click the Base Material button.
2.  Click the Show Map In Viewport button to turn it on.
3. On the Blinn Basic Parameters rollout, click the map button to the right of the Diffuse color swatch.

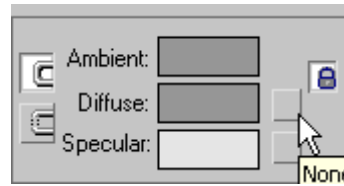

4. In the Material/Map Browser, double-click Bitmap.

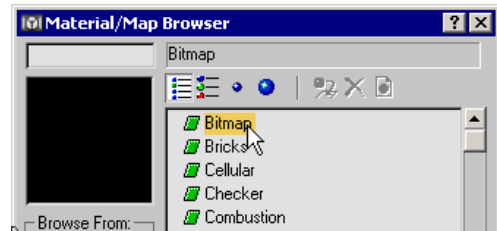

5. In the file selector dialog, choose the file *skin_tile.jpg*.
6. Click Open.

Adjust the shading for the base skin material:

1.  Click Go To Parent, and change the Material's shading type to Oren-Nayar-Blinn.

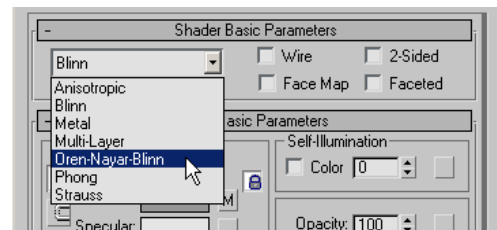

2. In the Oren-Nayar-Blinn Basic Parameters rollout > Specular Highlights group, set Specular Level to **27** and the Glossiness to **11**.

Apply bump mapping for the skin texture:

1. Expand the Maps rollout, and then drag the Diffuse Color map button (labeled with the map number and the file name *skin_tile.jpg*) to the Bump map button.

On the Copy (Instance) Map dialog, choose Copy (if necessary), and then click OK.

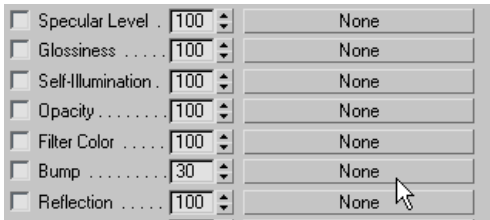

2. Click the Bump map button to open the parameters for the copied bitmap.

Set the tiling for bump mapping:

At the default tiling setting, the bump map is a bit coarse; increasing the Tiling values gives the bumpiness a finer grain.

- In the Coordinates rollout, enter **4.0** for both U and V Tiling values.

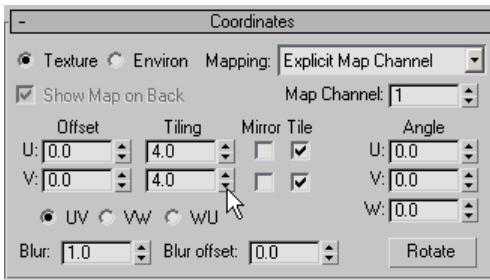

Adjust the amount of bump mapping:

1. Expand the Output rollout, and set the Bump Amount to **1.86**.

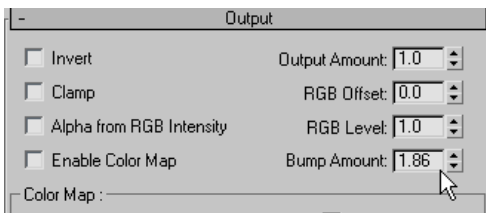

2.  Click Go to Parent.

3. In the Maps rollout, change the Bump Amount setting to **70**.



Set up the Shellac material:

1.  Click Go To Parent again, and in the Shellac Basic Parameters rollout, click the Shellac Material button.
2. Change the shading type to Anisotropic.

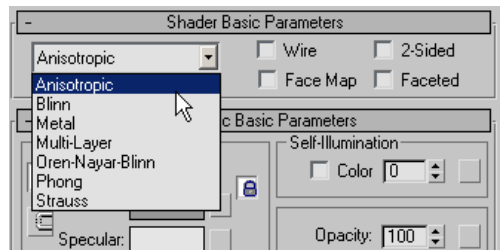

3. Click the map button to the right of the Diffuse color switch.

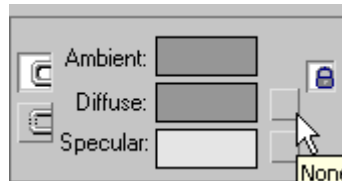

4. In the Material/Map Browser, double-click Bitmap.
5. Use the Select Bitmap Image File dialog to open the file *skin_tile.jpg*.

Set the tiling for the Shellac material map:

- On the Coordinates rollout, enter **4.0** for both U and V Tiling values.

Adjust the specular highlights for the Shellac material:

1.  Click Go To Parent, and then click the Specular color switch.

- In the Color Selector, change the color to a light skin tone: Red: **250**, Green: **224**, Blue: **195**, and click Close.

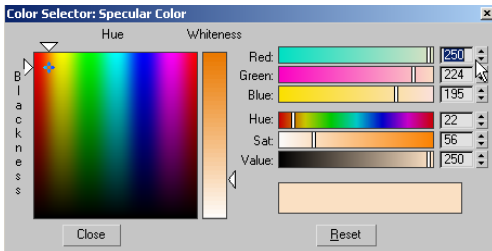

- In the Specular Highlight group, set Specular Level to **131**, Glossiness to **34**, and Anisotropy to **40**.

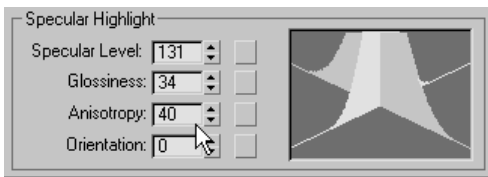

-  Click Go To Parent, and set Shellac Color Blend to **24**.

This gives the Shellac Material component a small but significant role in the look of the composite material.

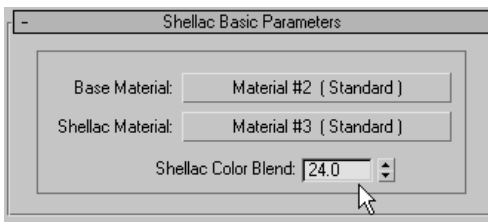

- Save the scene as **skin_material.max**
- Render the Camera01 viewport to see the result.

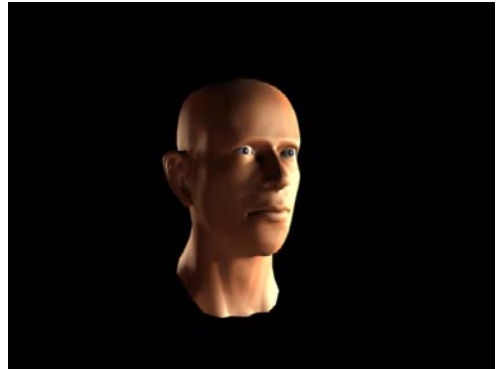

You've created a realistic-looking skin material. Try changing the parameters and components and re-rendering to see how they affect the material. In particular, try changing the Shellac Color Blend setting to blend different amounts of the Shellac Material component into the overall material.

Summary

3ds Max offers a wealth of options for applying textures to objects. You use the Material Editor for creating and modifying materials, applying maps, and even adjusting mapping. Once a material is ready, you can apply it to an object by dragging and dropping it from the Material Editor to the object in the viewport. The Material Editor provides a number of different shaders for achieving such effects as metal and translucency. The UVW Map modifier lets you determine how materials and maps wrap around an object. One of the most useful material types is Multi/Sub-Object, which lets you easily combine different materials on a single object. Another way is to use a map such as Checker, which gives you the option to apply two different maps in place of the black and white checks. You can add modeling detail to your objects with displacement mapping. The Shellac material is useful for simulating human skin, as well as other materials.

This tutorial provided a starting point for learning about materials, but the ultimate possibilities

with 3ds Max materials are limited only by your imagination. The time you spend practicing and experimenting with the procedures you learned here will be rewarded by a greater proficiency with the available tools, and the ability to get the effects you seek with ease and speed.

Materials for Interior Scenes

One of the most useful 3ds Max features for architectural models is its ability to fashion complex and subtle materials. The 3ds Max Material Editor provides you with ultimate control over the materials you create.



This tutorial focuses on material techniques that lend themselves to interior scenes. Outdoor scenes can use similar materials.

Skill Level: Beginner to Intermediate

Time to complete: 45 minutes

Features Covered in This Tutorial

After completing this tutorial, you should be able to:

- Use the Material Editor to create and assign materials.
- Create a simple “one-color” material.

- Use a map in a material.
- Create a multi/sub-object material for assigning multiple materials to a single object.
- Create a Blend material that includes a procedural map.
- Create and apply an Architectural material.
- Use the Asset Browser to find textures.
- Use the UVW Map modifier.

Files for This Tutorial

All the necessary files to do the tutorials can be found on the Tutorial Files CD that ships with 3ds Max 8. Before doing the tutorials, copy the *tutorials* directory from the CD to your *13dsmax8* local installation.

Materials of One Color: Applying Standard Materials

In this lesson, you create simple, “one-color” materials and apply them to objects in the scene. Specifically, you create the materials for a pair of chairs and an end table.

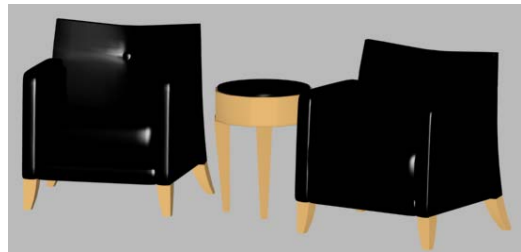

Material Components: Colors and Other Controls

In general, we think of simple standard materials (with no maps) as being of “one color”. In fact, an 3ds Max material consists of a number of component controls, and among these are a number of color components. The default Blinn shader, for example, uses three color components:

ambient, diffuse, and specular. Ambient is the color of the material in shadow, and specular is the color of highlights if the material is shiny. Diffuse, the color of the material under diffuse light, is what we usually think of as “the” color of a material. In the lessons of this tutorial, you work with the diffuse color component exclusively.

Materials have other non-color components, such as highlight and opacity controls. In these lessons, you adjust some highlights and map amounts, but don’t otherwise work with numeric material components.

Set up the scene:

- On the menu bar, choose File > Open. Locate *chairs.max* in the `|tutorials|designviz` folder, and click Open.

If you see the [File Load: Units Mismatch dialog](#), choose the option Adopt The File’s Unit Scale. This will change your system unit, so be sure to [reset your system unit after completing this tutorial](#).

To reset your system unit, go to the Customize menu and choose Units Setup > System Unit Setup > System Unit Scale > Inches.



If the geometry is not visible in the viewport, click the Zoom Extents All button twice to correct the display.

This scene contains only the chairs and the end table. At present, they are simply a dull gray.

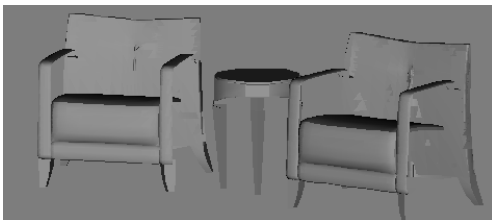

You will make the seats and the table top a glossy black leather, and the wood a flat brown.

Create a black leather material:



1. On the toolbar, click Material Editor.

The Material Editor is displayed. This is a large dialog for designing and applying materials. At the top of the dialog are sample slots that display material previews.

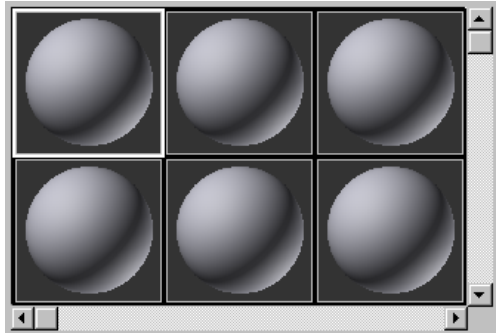

Sample slots show previews of materials on small sample objects such as spheres.

Below and to the right of the sample slots are various buttons and other controls. Below these tools are rollouts that are specific to a particular material type.

2. Make sure the first sample slot is active. If active, it has a heavy white border.
3. In the Material Editor, go to the Blinn Basic Parameters rollout.

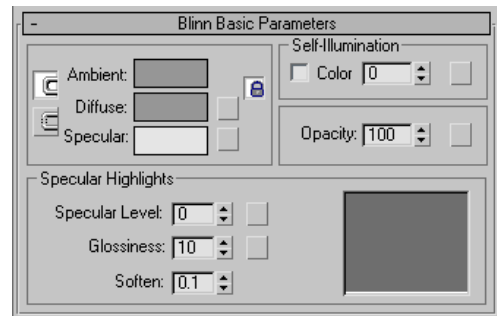

4. Click the gray color swatch labeled Diffuse. A Color Selector appears.

- In the Color Selector, change the diffuse color to black. The easiest way to do this is to drag the Whiteness slider all the way to the top. The RGB and HSV fields should both show 0,0,0.

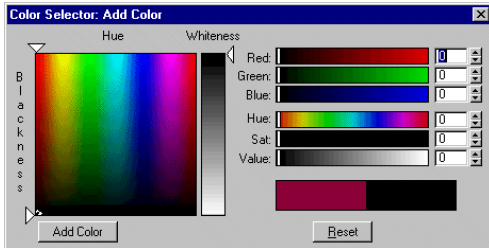

- In the Color Selector, click Close.

By default, the diffuse component is locked to the ambient component, so both the Diffuse and Ambient color swatches now appear black.

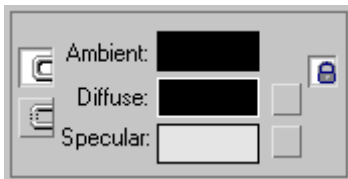

The material is very dark, as you can see in its sample slot. To look like leather, it needs to be shiny, too. To do this, you increase the intensity and size of the highlight.

- In the Blinn Basic Parameters rollout > Specular Highlights group, set the Specular Level to **79**.

As the highlight graph shows, there is now a large highlight. Increasing the value of Specular Level increases the height of the highlight curve.

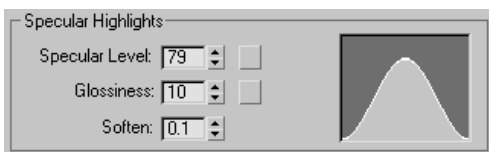

The effect is also apparent in the sample slot.

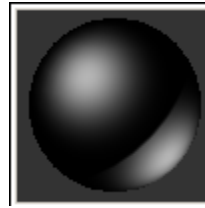

- In the Specular Highlights group, set the Glossiness to **54**.

The highlight graph shows that the highlight curve has become much narrower.

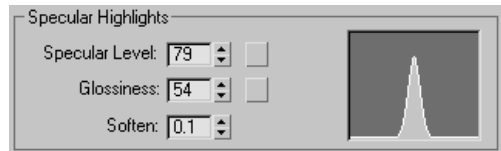

Increasing the value of Glossiness narrows the highlight curve. In general, small but intense highlights give the effect of shiny materials, as you can see in the sample slot.

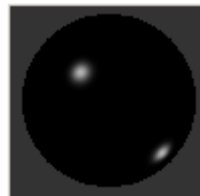

This is the effect intended for the leather upholstery, so give this material a name.

- In the material name field, below the sample slots, highlight the default name of 1 – Default (the number can vary), and enter **Black Leather**.

Apply the black leather material to the upholstered parts of the chairs:



- In a viewport, click to select the upholstered parts of the chairs and table.

In the wireframe viewports, these parts are blue.



The name Leather Parts should appear in the Name And Color rollout on the Create panel. If you go to the Modify panel, it should also appear in the object name field at the top of the panel.

2.  In the Material Editor, make sure the Black Leather material's sample slot is still active, and then click Assign Material To Selection.

In viewports, the upholstered areas now appear dark and the Black Leather sample slot has solid, white triangles at each corner indicating that the material is applied to the selected object(s) in the scene.

Create a simple wood material:

For this model, which is a small part of a much larger scene, the wood can be a simple brown color. Future exercises will show how to create more realistic wood textures.

1. In the Material Editor, click the second sample slot to make it active.
2. In the Blinn Basic Parameters rollout, click the Diffuse color swatch.
3. In the Color Selector, assign the hue, saturation, value (HSV) fields these values, respectively: **25, 129, 146**.

The red, green, blue (RGB) spinners update to show 146, 116, 72.

4. Close the Color Selector.

The Diffuse and Ambient color swatches now show a medium brown.

5. In the Specular Highlights group, set the Specular Level to **15**. Leave the Glossiness at the default value of 10.

Broad, shallow highlights give a material a matte appearance, as intended for the wood parts.

6. In the material name field, enter **Wood 1**.

Apply the wood material to the wooden parts of the chairs, and the table:

1.  In a viewport, click to select the leg of a chair or table.

In the wireframe viewports, this is the orange part of the model.



If you go to the Modify panel, the name Wood Parts should appear in the object name field at the top of the panel.

2.  In the Material Editor, make sure the Wood 1 material's sample slot is still active, and then click Assign Material To Selection.

In viewports, the wooden areas now appear brown.

Render the scene to see more of the effect:

1. Right-click the Perspective viewport to make sure it's active.



2. On the toolbar, click Quick Render.

The materials appear in the rendering. They are simple, but adequate as details of an architectural scene.

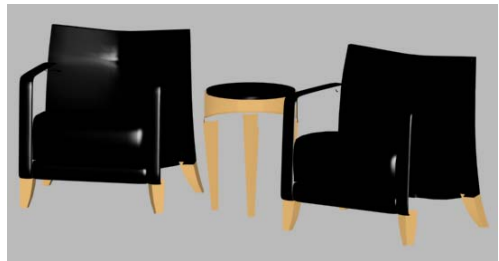

One problem with this rendering is that certain faces don't appear; specifically, the front of the end table and one side of the chair on the right. One way to fix this would be to go into the scene and flip the face normals of the nonrendering geometry, but there is a fix available in the Material Editor itself.

- For the Wood 1 material, go to the Shader Basic Parameter rollout and turn on 2-Sided. Then click the Black Leather sample slot to activate it, and turn on 2-Sided for the leather material as well.

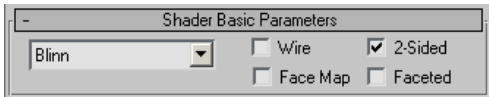

Turning on 2-sided is one way to make sure all of an object's geometry renders in a scene. Be aware that this can increase rendering time, especially in complex scenes.

-  Click Quick Render again.

This time, all of the furniture geometry renders.

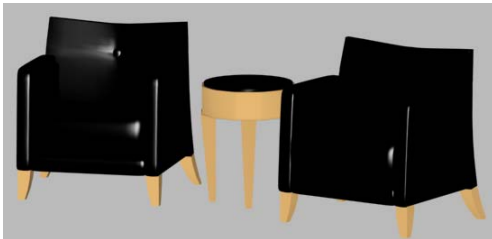

Save your work:

- Save the scene as **chairs_with_materials.max**.

Adding Complexity: Applying Mapped Materials

You can create more complex materials quite easily, by assigning a map to the diffuse color. A map applied to the diffuse color component is

often described as a *texture map*. For example, the bookshelves used in the library model have two textures: wood grain for the shelves, and books for the shelves' contents.



In this lesson, you create the mapped materials and apply them to a bookshelf model.

Set up the scene:

- On the menu bar, choose File > Open. Locate *bookshelf.max* in the *tutorials\designviz* folder, and click Open.

If you see the [File Load: Units Mismatch dialog](#), choose the option Adopt The File's Unit Scale. This will change your system unit, so be sure to [reset your system unit after completing this tutorial](#).

To reset your system unit, go to the Customize menu and choose Units Setup > System Unit Setup > System Unit Scale > Inches.



If the geometry is not visible in the viewport, click the Zoom Extents All button twice to correct the display.

This scene contains the bookshelf model, but with no textures applied.



Setting Texture Coordinates Preferences:

- From the Customize menu, choose Preferences.

- In the General tab, under the Texture Coordinates group, make sure the Use Real-World Texture Coordinates option is turned off.



- Click OK to exit the Preferences dialog.

Create the wood material:



- On the toolbar, click Material Editor.
- In the Material Editor, click the first sample slot to make it active (if it isn't already).
- On the Blinn Basic Parameters rollout, click the blank map button to the right of the Diffuse color swatch.

The Material/Map Browser dialog is displayed.

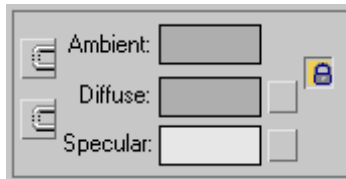

The map button is the gray square to the right of the diffuse color swatch.

If a map has been assigned, it shows the letter 'M.'

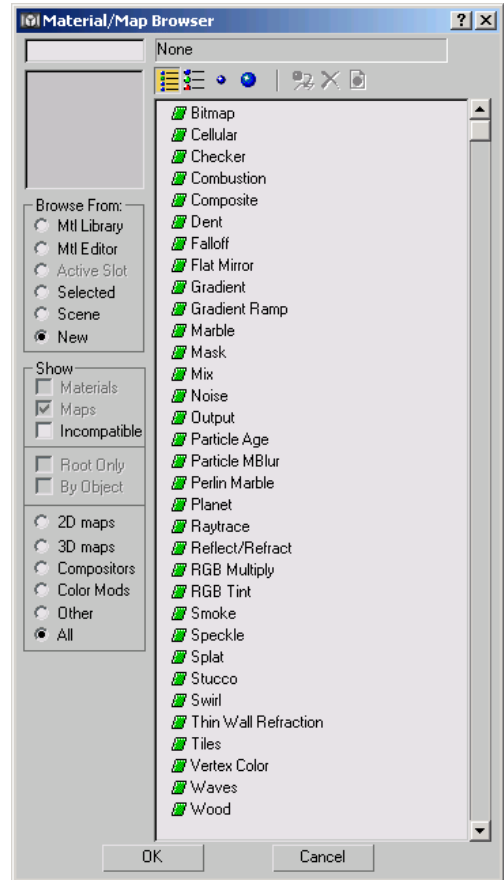

- In the Material/Map Browser, locate Bitmap in the list, and double-click it.

A Select Bitmap Image File dialog appears.

Most of the controls in this dialog are standard Windows file controls.

- In the same directory as the *bookshelf.max* file, choose the bitmap file named *wood02.jpg*, and then click Open.

In the Material Editor, the sample slot updates to show that the diffuse color of the material is now an image of the map file you chose.

Also, the rollouts area of the dialog now shows controls for the map, rather than the parent material.





Mapped wood material in sample slot



Solid corner tabs of a sample slot indicate that the material is used in the scene.

6.  Click the Go To Parent button to get back to the top level of your new material.
7. In the material name field, enter **Wood 2**.
By default, the material name is a generic name, *01 - Default*. Giving your materials more descriptive names will help you manage them more efficiently in the future.

Apply the wood to the bookshelves:

1.  On the toolbar, click Select By Name. In the Select By Name dialog that appears, choose Shelves in the list, and then click Select.
2.  In the Material Editor, make sure the Wood 2 sample slot is still active, and then click Assign Material To Selection.

The material is now applied to the shelves, and would appear in a rendering. However, it doesn't yet appear in shaded viewports.

Incidentally, when you apply the material, the sample slot shows solid, angled tabs at the corners. This is an indication in the Material Editor that the material in the slot is a material used in the scene.

3.  In the Material Editor, click to turn on Show Map In Viewport.

Now the shaded Perspective viewport shows that the shelves have a wood grain.

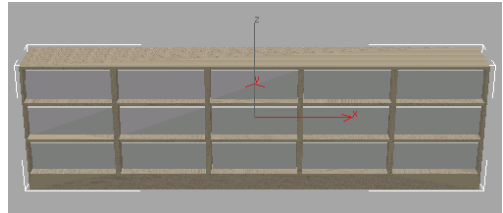

Tip: If you turn on Show Map In Viewport, but nothing changes in shaded viewports, this is probably because objects with the material do not have mapping coordinates. In this case, you need to apply a [UVW Map modifier](#). This modifier is used in later lessons of this tutorial.

Create the book material:

1. In the Material Editor, click the second sample slot to make it active.
2. On the Blinn Basic Parameters rollout, click the blank map button to the right of the Diffuse color swatch.

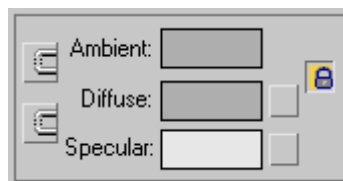

The map button is the gray square to the right of the diffuse color swatch.



3. In the Material/Map Browser, locate Bitmap in the list, and double-click it. The Select Bitmap Image File is displayed. In the same directory as the *bookshelf.max* file, choose the bitmap file named *books1.jpg*, and then click Open.

Although it is somewhat hard to see on the sphere in the sample slot, the texture for this material is a scanned image of books on a bookshelf.



4.  Click the Go To Parent button to get back to the top level of the material.
5. In the material name field, enter **Books**.

Apply the book material to the shelves:

1.  On the toolbar, click Select By Name. In the Select By Name dialog that appears, choose Books in the list, and then click Select.
2.  In the Material Editor, make sure the Books sample slot is still active, and then click Assign Material To Selection.
3.  In the Material Editor, click to turn on Show Map In Viewport.

Now the shaded Perspective viewport shows the shelves with books on them.



With just two image files, you have given the model a convincing amount of detail, especially

if the model is meant, like the bookshelf, to be a detail in a larger scene. Texture-mapped materials are a convenient way to add textures and images to your scene. (You can also use a map as a scene background image.)

Save your work:

- Save the scene as **bookshelf_with_maps.max**.

Applying Multiple Materials to One Object

The result of this lesson may appear to be similar to that in *Materials of One Color: Applying Standard Materials (page 1-155)*. This lesson, however, shows how to combine the leather and wood parts of the chairs into a single mesh, while retaining the material assignments.

Multi/Sub-Object Material

The trick to having multiple materials assigned to a single object is to use a multi/sub-object material. A multi/sub-object material is simply a container for other materials. As its name implies, it works at the sub-object level, assigning different sub-materials to different sub-objects of the model. (A variety of object types have sub-object levels, especially the surface models: editable mesh, editable poly, editable patch, and NURBS.)

Assigning sub-materials is a two-part process:

- Assign Face sub-objects a material ID value.
- Match materials contained in the multi/sub-object material to the ID values on the faces.

You can do these steps in either order.

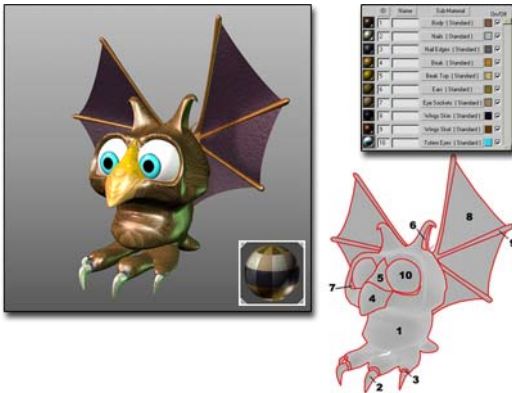

Figure mapped using a multi/sub-object material

Lower right: Different sub-objects have different material IDs.

Upper right: Multi/sub-object rollout maps the IDs to different sub-materials.

Set up the scene:

You can use a prepared file, or the file you worked on before. Do one of the following:

- Choose File > Open. Locate *chairs_assigned.max* in the `|tutorials|designviz` folder, and click Open.

If you see the [File Load: Units Mismatch dialog](#), choose the option Adopt The File's Unit Scale. This will change your system unit, so be sure to [reset your system unit after completing this tutorial](#).

To reset your system unit, go to the Customize menu and choose Units Setup > System Unit Setup > System Unit Scale > Inches.



If the geometry is not visible in the viewport, click the Zoom Extents All button twice to correct the display.

- Choose File > Open. Locate the file you created (*chairs_with_materials.max*), and click Open.

The chairs have materials assigned, but Leather Parts and Wood Parts are still two separate mesh objects.

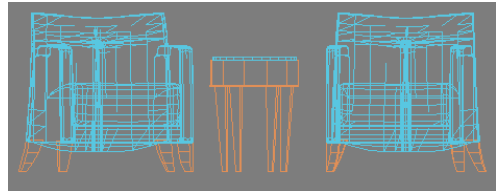



Wireframe views show that the leather and wooden parts of the chairs are two separate meshes.

Plan and assign material ID's:

When you work with sub-object materials, the first thing to do is to plan how to map the material ID numbers. The values on the geometry must match the values in the material, and vice versa. This is not a task for the 3D software, but for a design document, even if it's only a scrap of paper.

For this model, the wood parts will retain the default material ID of 1, and the leather parts will have a new material ID of 2.

1.  Select the Leather Parts mesh.
2.   Go to the Modify panel. The modifier stack display is the window below the object name and the drop-down Modifier List. This is where you choose a sub-object level. Click the plus icon next to the name Editable Mesh to see the mesh's sub-object levels.

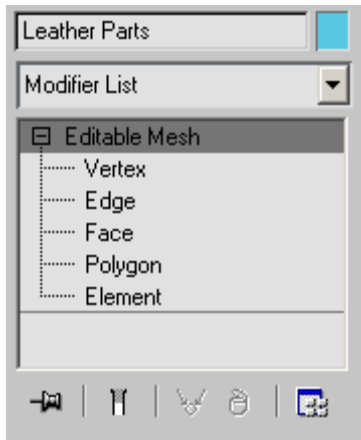
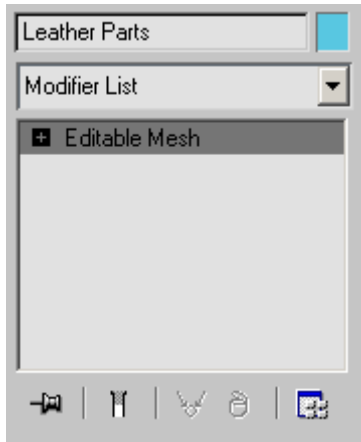

Top: After clicking the plus icon, the stack shows sub-object levels.

Bottom: The sub-object levels in the stack display.

3. Faces are the smallest renderable portions of a mesh. Click Face in the hierarchy.

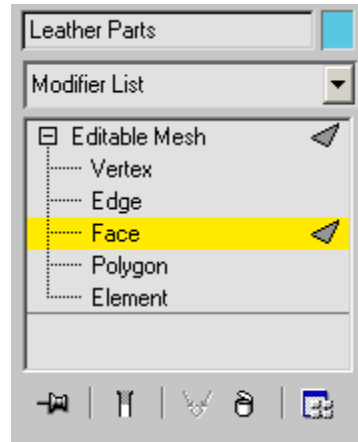

The stack with the Face sub-object level selected.

4. Choose Edit > Select All.

This selects all the faces in the Leather Parts object. By default, sub-object selections display in red.



5. On the Modify panel, go to the Surface Properties rollout. (This is the last rollout on the Modify panel.) In the Material group, increase the Set ID value from 1 to 2.
6. In the modifier stack display, click Editable Mesh again to return to the top, object level.

Combine the two meshes:



1. In a viewport, select the Wood Parts mesh.

The wood parts have material ID 1, so it makes sense to make them the basis of the combined mesh.



2. Go to the Modify panel. On the Edit Geometry rollout, click to turn on Attach. Then, in a viewport, click the Leather Parts mesh to attach it.

An Attach Options dialog is displayed.

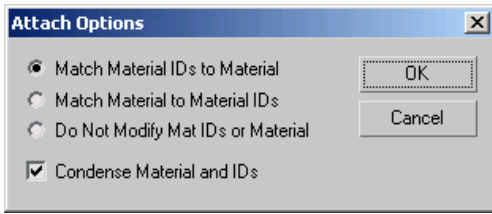

- In the Attach Options dialog, choose Do Not Modify Mat IDs Or Material, and then click OK.

This option leaves the material IDs on faces unchanged.

Tip: After attaching the parts of your model, be sure to turn off the Attach button. If you don't do this and want to make other object selections, you will inadvertently attach objects you don't want attached.

- In the object name field at the top of the Modify panel, type **Chair Group**.

Create the multi/sub-object material:



- On the toolbar, click Material Editor.
- In the Material Editor, click the third, unused sample slot to make it active.
- To the right of the material name field is the Material Type button. At present, its label says "Standard." Click this button.

The Material/Map Browser is displayed.

- In the Material/Map Browser list, double-click Multi/Sub-Object.

A Replace Material dialog is displayed.

- Choose Discard Old Material, and then click OK.

The Multi/Sub-Object Basic Parameters rollout is displayed in the Material Editor.

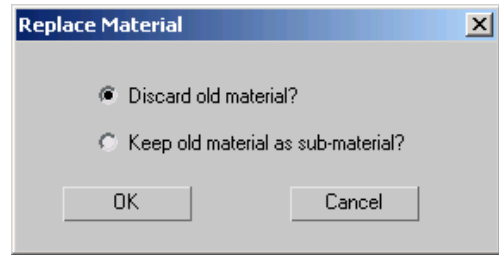

- By default, the multi/sub-object material contains 10 sub-materials. The chair group model needs only two. On the rollout, click Set Number. In the Set Number Of Materials dialog that is displayed, reduce the Number Of Materials value to **2**, and then click OK.
 - Drag the sample slot that contains the Black Leather material to the Multi/Sub-Object Basic Parameters rollout, and release the mouse when you are over the button for the second sub-material. This button is in the column labeled Sub-Material.
 - In the Instance (Copy) Material dialog that is displayed, leave Instance chosen, and click OK.
- The new sub-material corresponds to Material ID 2.

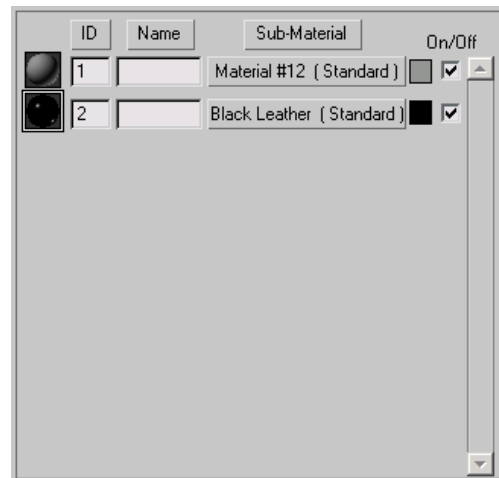

Controls in the Multi/Sub-Object Basic Parameters rollout after dragging the Black Leather material to the second sub-material's button.

- Drag the sample slot that contains the Wood 1 material to the Multi/Sub-Object Basic Parameters rollout, and release the mouse when you are over the button for the first sub-material. As before, accept Instance and click OK.

This sub-material corresponds to Material ID 1.



Tip: You can change material ID assignments in the Material Editor, by editing the values in the ID column of the Multi/Sub-Object Basic Parameters rollout. You can also change them on the geometry side by using the Material group of the Surface Properties rollout.



Sample sphere for the multi/sub-object material

Assign the material to the mesh:

The multi/sub-object material is now complete. The last step is to assign it to the model.

-  In a viewport, click to select the Chair Group model.
-  In the Material Editor, click Assign Material To Selection.

The appearance of the model is unchanged, but it now consists of a single editable mesh, so you can use it with the Substitute modifier.

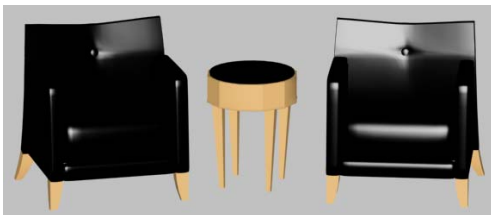

Save your work:

- Save the scene as **chair_group_single_mesh.max**.

Creating 3D Materials: Another Approach to Wood

In an earlier lesson, you created a wood material using a bitmap. In this lesson, you create a wood effect using the built-in Wood material. This is an example of a 3D material. 3D materials, also known as *procedural materials*, are generated by the software. This lets you adjust their settings interactively.

Another advantage of 3D materials is the way they exist in three dimensions. If you slice an object with 3D Wood applied, you see the interior grain, as you would if you sawed into a real piece of wood.

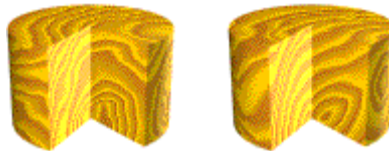

3D materials pervade an object. "Cutting" an object with a 3D wood material (for example, by using a Boolean operation) reveals interior grain.

Set up the scene:

- On the menu bar, choose File > Open. Locate *kitchen.max* in the `|tutorials|designviz` folder, and click Open.

If you see the [File Load: Units Mismatch dialog](#), choose the option Adopt The File's Unit Scale. This will change your system unit, so be sure to [reset your system unit after completing this tutorial](#).

If you do not adopt the file's unit scale, the material you create will be out of proportion and some of the settings you make will show poor results.



This scene is a model of a kitchen. At present, it has a clean, industrial look.

You will add textures to make some surfaces wood, giving the kitchen a warmer look. (In the exercises that follow, you will also create a brick material for the wall and add a tile material to the floor.)

Creating a wood material:



1. On the toolbar, click Material Editor.

Tip: You can also press the **M** keyboard shortcut to open the Material Editor.

2. In the Material Editor, click an unused sample slot to make it active.

Reminder: Unused sample slots have no angle brackets in their corners. Used sample slots have angled corners.

3. In the material name field, enter **Wood 3**.
4. On the Shader Basic Parameters rollout, change the shader type from Blinn to Anisotropic.
5. On the Anisotropic Basic Parameters rollout, click the blank map button to the right of the Diffuse color swatch.

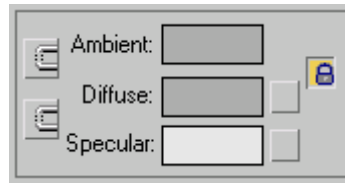

The map button is the gray square to the right of the diffuse color swatch.

The Material/Map Browser dialog is displayed.

Note: Anisotropic is a variant of the default Blinn shader.

6. In the Material/Map Browser, scroll to the bottom of the list, then double-click the Wood entry.

A wood-grain material appears in the sample slot.



Adjusting the colors and settings:

The default colors for this material are darker than you would probably want to use in a kitchen design. You will change them to lighter shades of the same hue.

1. In the Wood Parameters rollout, click the Color #1 swatch.
2. In the Color Selector, assign the hue, saturation, value (HSV) fields these values, respectively: **34, 119, 214**. (Hue does not change.)

The red, green, blue (RGB) spinners update to show 214, 194, 114.

3. In the Wood Parameters rollout, click the Color #2 swatch.

4. In the Color Selector, assign the hue, saturation, value (HSV) fields these values, respectively: **25, 121, 169**. (Hue does not change.)

The red, green, blue (RGB) spinners update to show 169, 136, 89.

5. Close the Color Selector.
6. In the Wood Parameters rollout, change Radial Noise to **2.0**, and Axial Noise to **1.2**.

This gives the grain a “noisier” or “busier” appearance.



Applying the material to the scene:

1. On the toolbar, open the Named Selection Sets drop-down list, and choose *Wood Surfaces*.

This selection set consists of the portions of the kitchen that will have wood.

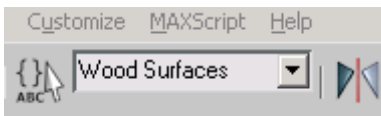
Tip: The Named Selection Sets list is between the Named Selection Sets button and the Mirror Selected Objects button.



2.   In the Material Editor, click Assign Material To Selection, and then click to turn on Show Map In Viewport.

The wood grain appears on objects in the scene.



Rendering to view the wood effect:

Viewport display of 3D materials is usually only a rough approximation. To see the full effect, you need to render the scene.

-  On the toolbar, click Quick Render.



In the rendering, you can see that the wood grain is much too large. This wood has come from a very big tree! To make the material more realistic, you can adjust the material.

Adjusting the size of the wood grain:

1. Minimize the rendered frame window.
2. In the Material Editor > Wood Parameters rollout, change the Grain Thickness to **0.7**.

With the grain a tenth of its former size, the preview in the viewport looks very busy.

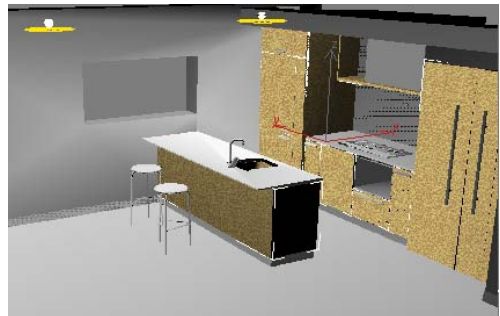

As a rule of thumb for scenes of this scale, if the grain is too “busy” and indistinct in viewports, it is probably about the right size for the renderer.

3.  Click Quick Render.

The rendered scene looks much more convincing. However, the grain appears to be end-on, which isn’t right.

Adjusting the direction of the wood grain:

1. Minimize the rendered frame window.
2. In the Material Editor > Coordinates rollout, change the X Angle and Y Angle to **90** (degrees).

The Angle values for X, Y, and Z are the third column of spinners.

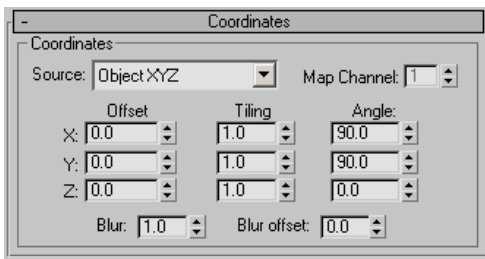

3.  Click Quick Render.

Changing the grain angle doesn’t have much effect on the viewport preview, but it greatly improves the rendered scene.



Saving your work:

- Save the scene as **mykitchen_wood.max**.

Next, you’ll learn about the Architectural material.

Using an Architectural Material on the Wall

The Architectural Material in 3ds Max provides heightened realism when used with photometric lights and radiosity, because its settings are based on physical properties.

The Architectural material lets you choose from a series of templates of preset parameters for the material. These templates approximate the general characteristics of the kind of materials you’re creating, such as masonry, glass, or painted surfaces, for example.

Note: The Architectural material is not meant to be used with standard 3ds Max lights or with the Light Tracer.

In this lesson, you’ll explore the Architectural material and its application to a scene. You’ll be using the material to create a texture for the wall of the kitchen.

Set up the scene:

1. Continue from the previous lesson, or choose File menu > Open and browse to the `|tutorials|designviz` folder. Open `kitchen_with_wood.max`.

Note: If you see the [File Load: Units Mismatch dialog](#), choose the option Adopt The File's Unit Scale. This will change your system unit, so be sure to [reset your system unit after completing this tutorial](#).

2.  If the geometry is not visible in the viewport, click the Zoom Extents All button twice to correct the display.

The next material you'll create for this kitchen is a brick material for the wall.

Setting Texture Coordinates Preferences:

1. From the Customize menu, choose Preferences.
2. In the General tab, under the Texture Coordinates group, make sure the Use Real-World Texture Coordinates option is turned off.

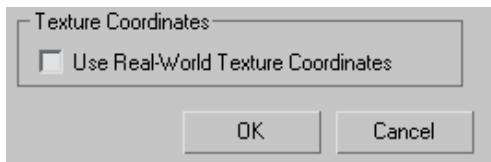

3. Click OK to exit the Preferences dialog.

Creating a brick material for the wall:

1.  On the toolbar, click the Material Editor button.
2. In the Material Editor, click an unused sample slot to make it active.
3. Click the Standard button to open the Material/Map Browser and choose Architectural. Click OK.

4. In the Templates rollout, open the Templates list and choose some of the different material presets and watch the Physical Qualities rollout. You'll see how the material presets fill in the physical characteristics for Shininess, Luminance, and so forth.
5. Choose **Masonry** before you continue.
6. In the Physical Qualities rollout, click the Diffuse Map button. It currently says None.
7. Choose *Tiles* from the list of map types and click OK.

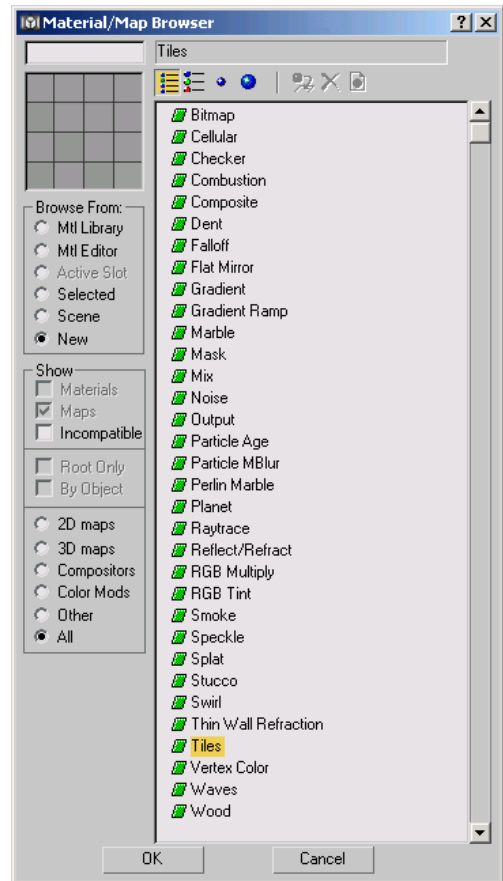

8. From the Standard Controls rollout, open the Preset Type list and choose *Running Bond*.

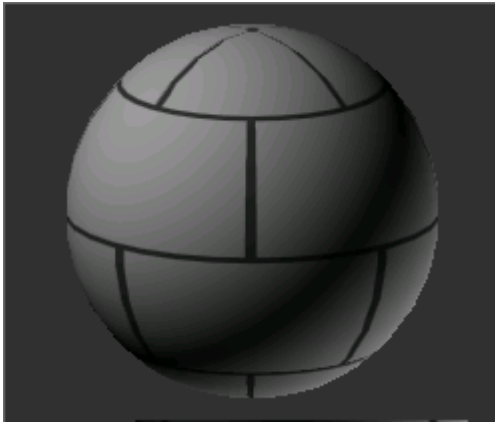

A typical, staggered placement of bricks

9. Open the Advanced Controls rollout and click the Texture map button in the Tiles Setup group.

The Material/Map Browser reopens.

10. Choose Noise and click OK.

The Material Editor shows you the Noise Parameters.

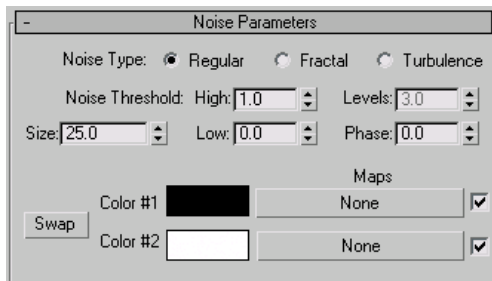

11. In the Noise Parameters rollout, set the Noise Type to Fractal and the Size to 10.
12. Click the Color #1 swatch and set a deep red color in the Color Selector. Some good settings are Red: 112, Green: 5, and Blue: 0.
13. Click the Color #2 swatch and set a lighter red color in the Color Selector: 180, Green: 106, and Blue: 106. Close the Color Selector dialog.
14.  Click the Go To Parent button.

15. In the Tiles Setup group of the Advanced Controls rollout, set the Horiz. Count to 6.0, Vert. Count to 14.0, and Color Variance to 0.63.

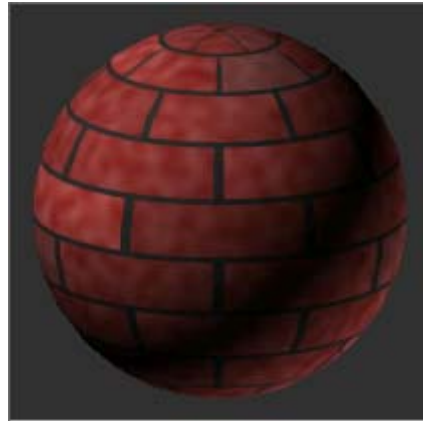

16. In the Grout Setup group, click the Texture switch to re-open the Color Selector.
17. Set the Value setting to 90, then close the dialog.
Tip: If you know a color needs to be black, white or any shade of gray in between, the Red, Green and Blue values must be the same. Adjusting the Value setting automatically assigns the same value to Red, Green and Blue.
18. Set the Rough value to 5.0 to give the mortar joints a little irregularity.
19.  Click the Go To Parent button.

This puts you at the top level of your material.

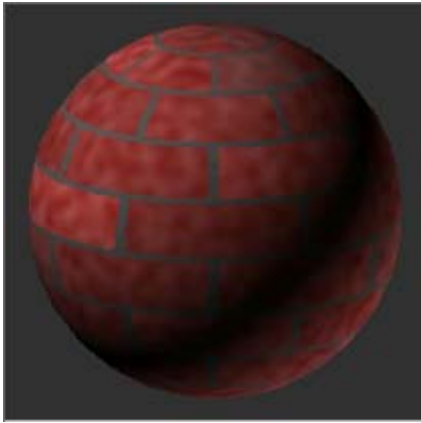

The primary brick mapping is complete.

To make the material more realistic, you're now going to add a bump map.

Adding realism with a bump map:

1. Open the Special Effects rollout and make sure the size of the Materials Editor dialog lets you see both the Physical Qualities and Special Effects rollouts.
2. In the Physical Qualities rollout, click the Diffuse Map button and drag it down onto the Bump map button.
The Instance (Copy) Map dialog is displayed.
3. Choose Copy and click OK.
You're using Copy for this example because you want to make unique settings for the bump map. If you chose Instance, any change you make to the bump map would propagate to the diffuse map.
4. Click the Bump map button to begin working on the bump map for the bricks.
5. Click the Noise map on the Tiles Setup group in the Advanced Controls rollout.
6. In the Noise Parameters rollout, leave the Noise Type set to Fractal and set the Size to **15.0**.

7. Click the Color #1 swatch to open the Color Selector, and drag the Whiteness slider all that way to the bottom to give you a solid white.
8. Click the Color #2 swatch and set the Red value to **126** and Green and Blue values to **0**. Close the Color Selector.

Tip: To quickly set spinner values to zero, right-click the spinner arrows.



9. Click the Go To Parent button.
10. Click the Texture map button in the Grout Setup group.
The Material/Map Browser is displayed.
11. Click the *Tiles* map and click OK.
12. In the Standard Controls rollout, set the Preset Type to *Running Bond*.

You want to duplicate most of the Tiles map settings you used for the Diffuse map. These settings will ensure that the grout lines for the Bump map align properly with the Diffuse map.

13. In the Advanced Controls rollout, in the Tiles Setup group, set the Horiz. Count to **6.0** and Vert. Count to **14.0**.
14. Click the Texture swatch for the Tiles Setup and set it to black.
Dark colors are embossed when used with a Bump map.
15. In the Grout Setup group, click the Texture swatch and set it to white.
Lighter colors, on a Bump map, are recessed. These will form the depressions along the mortar joints.
16. Close the Color Selector and enter a Rough value of **5.0** for the Grout Setup.



17. Click the Go To Parent button twice to get back to the top level of your material.

18. In the Special Effects rollout, set the Bump amount to **50.0**, and then rename the material **MyRedBricks**.

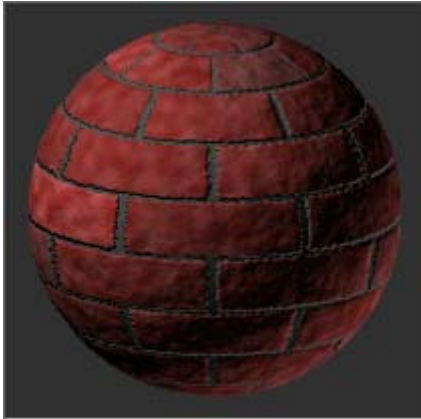

Now your material is done and ready to apply to the wall.

Assigning texture coordinates:

1. Activate the Camera01 viewport and select the wall object named *VC Wall*.



The wall is selected.

Before you can apply the brick material to the wall, the wall needs texture coordinates.

Without texture coordinates, the texture map will not show up and you will receive a Missing

Map Coordinates message when you render the scene.

2.  Open the Modify panel and click the down arrow of the Modifier List.
3. Scroll down the list and choose MapScaler from the Object Space Modifiers grouping.



Texture coordinates (UVWs) are assigned to the object when the modifier is applied.

Applying the bricks to the wall:

1. In the Material Editor, click your brick material and drag it onto the wall.
2.  In the Material Editor, click the Show Map In Viewport button.

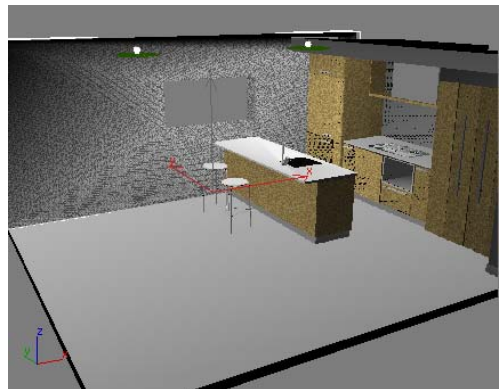

The scale of the texture is way too small. The default scale of the MapScaler modifier is 1”.

3. In the Parameters rollout, set the Scale to 2’6”.

The bricks are more proportional now.



Note: If the bricks appear crooked, right-click the Camera01 viewport label and turn on Texture Correction if 3ds Max is configured to use the Software display driver. Next you deal with the brick size.

4. Save the scene as **mykitchen_brick.max**.



5. Click Quick Render.



The kitchen of your trendy loft.

Material Combinations: Using Blend to Create a Floor Material

The Material Editor provides a number of ways to combine materials. Bitmaps and procedural (3D) materials will probably serve your needs for most models, but this lesson is an example of the versatility of the Material Editor.

In this lesson, you create a complex Blend material for the tile floor in the kitchen.

Set up the scene:

- Continue from the previous lesson, or open the file, *kitchen_with_brick.max* located in the *|tutorials|designviz* folder.

Note: If you see the [File Load: Units Mismatch dialog](#), choose the option Adopt The File’s Unit Scale. This will change your system unit, so be sure to [reset your system unit after completing this tutorial](#).

Setting Texture Coordinates Preferences:

1. From the Customize menu, choose Preferences.
2. In the General tab, under the Texture Coordinates group, make sure the Use Real-World Texture Coordinates option is turned off.

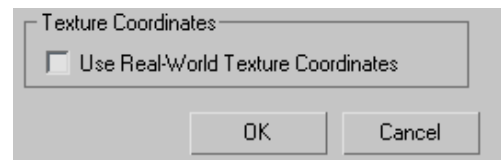

3. Click OK to exit the Preferences dialog.

Create the floor material:



1. In the Material Editor, select an unused sample slot.
2. In the material name field, enter **Floor Tile**.

3. Click the Material Type button to the right of the material name field. (Initially, its label says “Standard.”)
4. In the Material/Map Browser, double-click Blend in the list.
A Replace Material dialog is displayed.
5. Choose Discard Old Material, and then click OK.



Like the Multi/Sub-Object material, a Blend material is a container for other materials. The Multi/Sub-Object material apportions sub-materials among different sub-objects. The Blend material, on the other hand, blends the colors and other attributes of its sub-materials. You can also control the amount and the method of blending.

Configure the sub-materials:

1.  On the Material Editor toolbar, open the Material/Map Navigator.

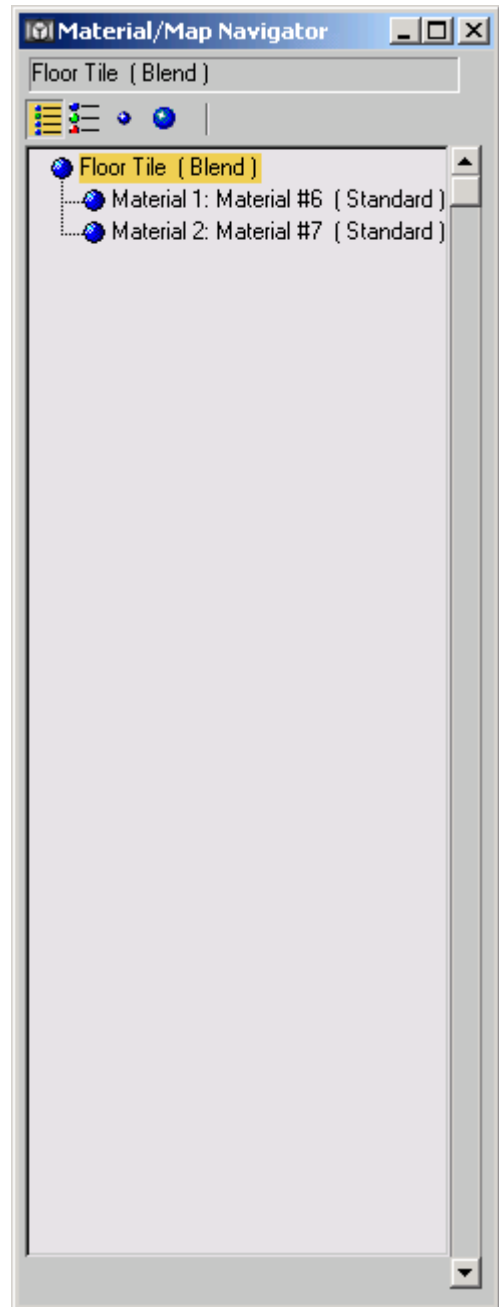
The Material/Map Navigator is a dialog that shows the components of the material in the active sample slot. For complex materials such as Blend, it can help you to visualize and navigate the material hierarchy.



Note:   The Navigator is one way to move about the hierarchy of a complex

material. Another is to use the Go To Parent and Go Forward To Sibling buttons on the Material Editor toolbar.

2. In the Material/Map Navigator, click Material 1.
3. In the material name field of the Material Editor, rename this material **Grout**.
4. In the Material/Map Navigator, click Material 2.
5. In the material name field of the Material Editor, rename this material **Tile Surface**.

Sub-material names are automatically updated in the Material/Map Navigator.

Set the texture and color of the grout:

1. In the Material/Map Navigator, choose the Grout material.
2. In the Material Editor > Blinn Basic Parameters rollout, click the blank map button to the right of the Diffuse color swatch.

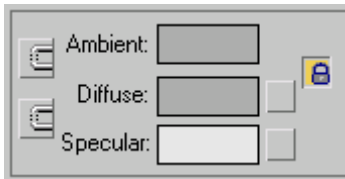

The map button is the gray square to the right of the diffuse color swatch.

3. In the Material/Map Browser, double-click Noise in list.
This applies a Noise map as a texture for the Grout material.
4. In Noise Parameters rollout, change the Size to **3**, and choose Turbulence as the Noise Type.



This gives the Grout material a grainy texture, as you can see in the sample slot if you turn off Show End Result in the Material Editor toolbar.

-  When the Show End Result button is on, the final result of the top-level material is shown on the sample sphere.

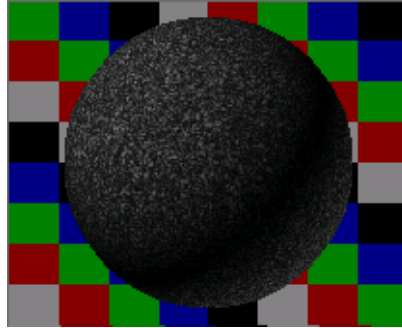

Show End Result turned on - Background turned on for clarity.

-  When Show End Result is off, you are shown only the material level you are working on. That way it is easier to view your adjustments to a specific map.

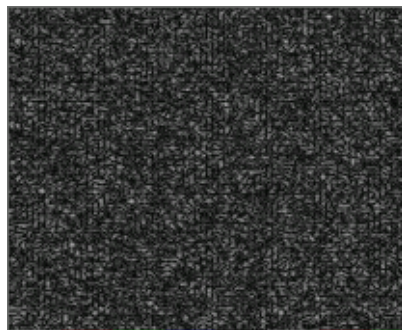

Show End Result turned off.

5. In the Noise Parameters rollout, click the Color #1 color swatch (black by default).
6. In the Color Selector, change Color#1 to R=232, G=219, B=197.
7. In the Noise Parameters rollout, click the Color #2 color swatch (white by default).
8. In the Color Selector, change Color#2 to R=196, G=170, B=159.

- Close the Color Selector.

Add a bump pattern to the grout:

- In the Material/Map Navigator, choose the Grout material.

Previously, the Noise map was active.

Note:  You can also click the Go to Parent button to move up one level to the Grout material.

-  Go to the Utilities panel. Click Asset Browser. Answer OK to the warning dialog, and then resize the Asset Browser window so you can see both the Browser controls and the Material Editor.
- In the Asset Browser, navigate to the `|tutorials|designviz` folder.
- In the Material Editor, open the Maps rollout for the Grout material.
- Drag the file `glasblkb.gif` (the image looks like a tile pattern) from the Asset Browser to the blank (“None”) Bump map button in the Material Editor. Release the mouse.

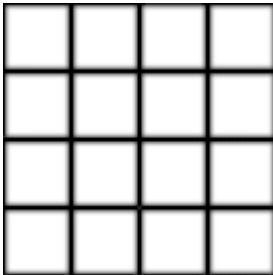

The image in `glasblkb.gif`

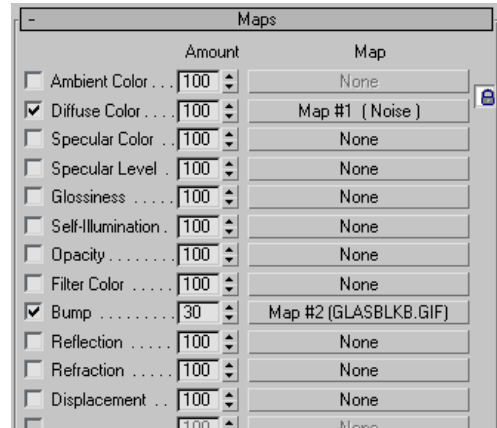

The Maps rollout with `glasblkb.gif` assigned to the Bump map button

Just as you can search for geometry models, you can use the Asset Browser to find bitmap files and use them in the scene. The Asset Browser also gives you the freedom to search for models and bitmaps anywhere on your local hard drives or across the Internet.

- Minimize the Asset Browser.
- In the Material Editor > Maps rollout, change the Bump map’s Amount to **50**.

The Grout material now has a grid-like bumpiness.

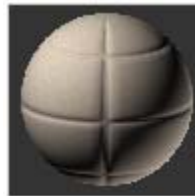

Set the texture and color of the tile surfaces:

- In the Material/Map Navigator, choose the Tile Surface material.
-  On the Material Editor toolbar, click to turn off Show End Result.

- In the Material Editor > Blinn Basic Parameters rollout, click the blank map button to the right of the Diffuse color swatch.

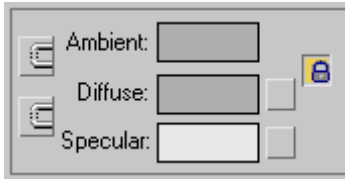

The map button is the gray square to the right of the diffuse color swatch.

- In the Material/Map Browser, double-click Noise in list.
This applies a Noise map as a texture for the Tile Surface material.
- In the Noise Parameters rollout, change the Size to 10.
- In the Noise Parameters rollout, click the Color #1 color swatch. (Black by default.)
- In the Color Selector, change Color#1 to R=220, G=197, B=181.
- In the Noise Parameters rollout, click the Color #2 color swatch. (White by default.)
- In the Color Selector, change Color#2 to R=162, G=132, B=111.
- Close the Color Selector.

The tile surface is also “noisy” or rough, and somewhat darker than the grout.

Change the shininess and bumpiness of the tile surfaces:

- In the Material/Map Navigator, choose the Tile Surface material.
Previously, the Noise map was active.
- In the Blinn Basic Parameters, go to the Specular Highlights group. Change the Specular Level to 15. Leave Glossiness set to 10.
- In the Maps rollout, click the Bump map button.

- In the Material/Map Browser, double-click Noise in the list.
- In the Noise Parameters rollout, change the Size to 1.



- Click Go To Parent.

This takes you to the parent Tile Surface material. The highlight in the Navigator indicates the change.

- In the Maps rollout, change the Amount for the bump map to 15.

Combine the two materials by using a mask:

The Blend material now has two sub-materials, Grout and Tile Surface. You will use a bitmap file as a mask to combine them.

- In the Material/Map Navigator, choose Floor Tile (Blend).

This is the top level of the material. The Blend Basic Parameters rollout shows the two component sub-materials.

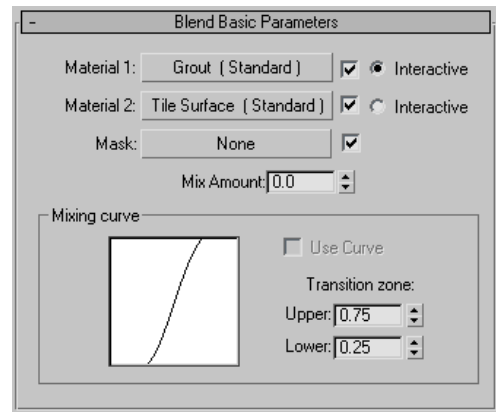

- Restore the Asset Browser.
- Drag the file *glasblkb.gif* from the Asset Browser to the Mask button on the Blend Basic Parameters rollout.
- Minimize the Asset Browser.

Rename the mask:

1. On the Blend Basic Parameters rollout, click the Mask button.
2. In the material name field, rename the mask map **Grout Lines**.

Adjust the blending:

1. In the Material/Map Navigator, select the Floor Tile (Blend) material.

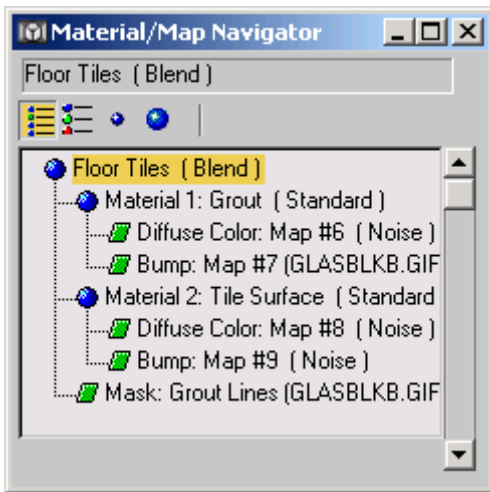



Floor Tile, the blend material, is the top material in the tree.

The Navigator now shows all component materials and maps of the Floor Tile material.

2. In the Blend Basic Parameters rollout > Mixing Curve group, turn on Use Curve.
3. Change the Transition Zone Upper amount to **1.0** and the Lower amount to **0.0**.

This gives a crisp appearance to the grooves.

Apply the material to the floor:

1.  In the viewport, select the Floor object.
2.  In the Material Editor, click Assign Material To Selection.

Assign coordinates to the floor:

1.  With the Floor still selected, go to the Modify panel.
2. Open the drop-down Modifier List and choose UVW Map.

This guarantees that the floor has mapping coordinates the Floor Tile material can use, and gives you a means to adjust them. You will need to, as the following steps demonstrate.

Render the scene:

-  On the toolbar, click Quick Render.

The floor has a tiled appearance, but the tiles are far too large.



You will correct the tile size in the following lesson.

Save your work:

- On the menu bar, choose File > Save As. Name your design **mykitchen_with_tile_floor.max**. You can use this file in the following lesson.

Using the UVW Map Modifier to Adjust the Floor Tiles

In the previous lesson, you tiled the floor, but found that with default mapping, the tiles appeared too large. The tiles should be 10" x 10", with roughly 1/4" grout lines between each tile. You can use the UVW Map modifier to set these values.

Set up the scene:

1. Continue from the previous lesson, or open the file, *kitchen_with_tile_floor.max* found in the *|tutorial|designviz* folder.

Note: If you see the [File Load: Units Mismatch dialog](#), choose the option Adopt The File's Unit Scale. This will change your system unit, so be sure to [reset your system unit after completing this tutorial](#).

2. Close the Material Editor and the Asset Browser.

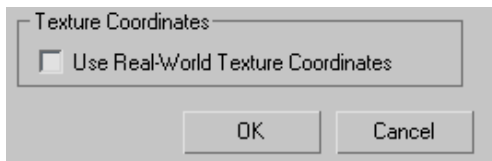

Setting Texture Coordinates Preferences:

1. From the Customize menu, choose Preferences.
2. In the General tab, under the Texture Coordinates group, make sure the Use Real-World Texture Coordinates option is turned off.



3. Click OK to exit the Preferences dialog.

Adjust the floor tile size:

1.  Select the Floor object.
2.  Go to the Modify panel.

3. With UVW Mapping selected in the modifier stack display, go to the Parameters rollout and change the Length and Width values to 3'5". (The Floor Tile material has four tiles in each dimension, with grout lines around them.)



4. Click Quick Render.

The tile dimensions are now correct.



Save your work:

- On the menu bar, choose File menu > Save As and name the finished model **mykitchen_final.max**.

Summary

This completes the material design tutorial. Features it has covered include:

- Using the Material Editor to create and assign materials.
- Creating a simple “one-color” material.
- Using a map in a material.
- Creating a multi/sub-object material for assigning multiple materials to a single object.
- Using the Architectural material to use the material presets.
- Creating a Blend material that includes a procedural map.
- Using the Asset Browser to find textures.

- Using the UVW Map modifier.

Using Map Scaler

Among the more useful tools for design visualization in 3ds Max are the MapScaler modifiers. Available in both object-space and world-space versions, their primary purpose is to allow scaling bitmapped materials applied to objects separately from the objects themselves. Thus, you can instance a modifier to numerous, different-size objects in a scene, and thereafter set one parameter for a uniform map scale throughout the scene. In this tutorial, you'll learn how to accomplish this, and also observe some of the differences between the two MapScaler modifier types.

The MapScaler modifier is useful in situations where geometry has not been mapped. For example, if you import or link a DWG file that doesn't have UV coordinates, the MapScaler modifier is very useful for quickly mapping objects. Also, the MapScaler modifier is particularly useful for objects such as curved walls which don't map well with the UVW Map modifier.

Skill Level: Beginner

Time to complete: 30 minutes

Features Covered in This Tutorial

After completing this tutorial, you should be able to:

- Use the MapScaler modifiers to apply uniform texturing to different-sized objects in a scene.
- Use the MapScaler modifiers to apply uniform texturing to complex geometry in a scene.
- Understand the differences between the two MapScaler versions and use each appropriately.

Tutorial Files

All the necessary files to do the tutorials can be found on the Tutorial And Sample Files CD, in the *|tutorials|new_materials|* folder, unless otherwise specified. Before beginning the tutorials, copy the *|tutorials|* directory from the CD to your *|3dsmax8|* local installation.

Applying Uniform Textures to Different-Sized Objects

By default, in 3ds Max, the size of an object determines the size of a bitmapped texture that you apply to it. However, the MapScaler modifier lets you scale a texture independently of the sizes of objects it's applied to. Moreover, once it's applied to an object, you can change the object's size without affecting the scale of the texture. You'll explore these capabilities in this lesson.

The files for this tutorial are in the *|tutorials|new_materials|* folder.

Set Texture Coordinates preferences:

1. From the Customize menu, choose Preferences.
2. In the General tab, under the Texture Coordinates group, make sure the Use Real-World Texture Coordinates option is turned off.

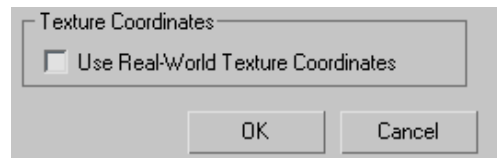

3. Click OK to exit the Preferences dialog.

Open the scene and apply a bricks texture:

1. Open the file *|tutorials|new_materials|plaza.max*.

The scene is of a small building plaza containing objects of various sizes and shapes.

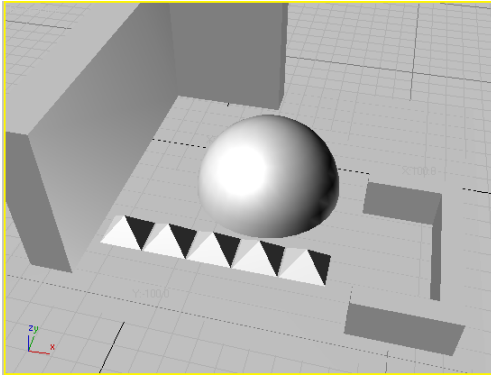

You'll create a brick texture and apply it to all the objects.

2. Press **M** to open the Material Editor.

The first material, represented by the upper-left sample sphere, is active, and has been named Brick and set to use a Standard material. You'll apply Diffuse map containing a brick image.

3. In the Material Editor, to the right of the Diffuse color swatch, click the square button.

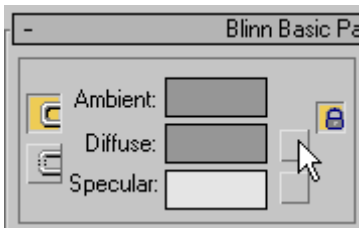

The Material/Map Browser dialog opens.

4. Double-click the Bitmap list entry.
The Select Bitmap Image File dialog opens.
5. If necessary, navigate to the directory from which you opened the scene file, and then open the *brkrun.jpg* file.

The brick image appears on the sample sphere.

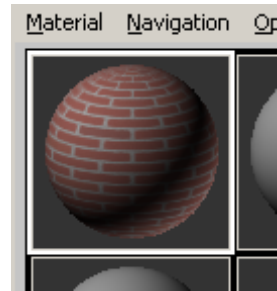

6.  Click the Show Map In Viewport button on the Material Editor dialog.

This lets you see the brick image in shaded viewports on objects to which the material is applied.

7. Press **CTRL+A** to select all objects in the scene.

8.  Click the Assign Material To Selection button on the Material Editor dialog.

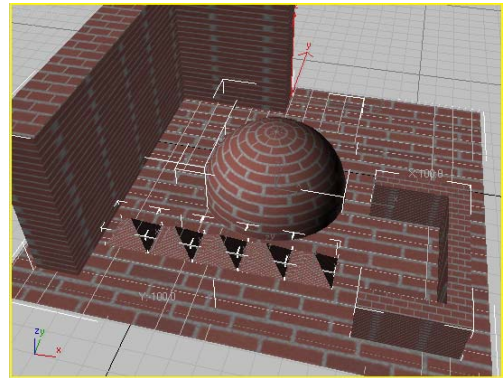

The brick texture appears on all the objects in the viewport, but the brick sizes differ from object to object. On the small pyramid objects the bricks are tiny, while on the bigger objects such as the hemisphere the bricks are too large. Also, the bricks on the sides of the L-Ext and C-Ext objects are stretched out, while they maintain correct proportions on top. Of course, in a real-world structure the bricks are

usually all the same size. You'll accomplish this in the next step.

Use a modifier to make the bricks a uniform size:



1. With all the objects still selected, go to the Modify panel, click the Modifier List, and choose Object-Space Modifiers > MapScaler. On the Modify panel, make sure the Scale value is set to **100.0**, the default setting.

This applies the modifier as an instance to all the objects in the scene. Thus, changing any parameter in one instance of the modifier changes all instances identically.

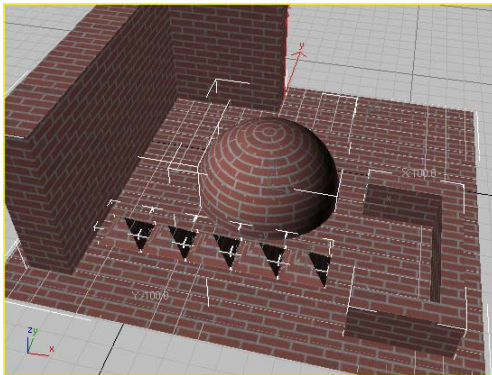

The bricks are all now the same size, but they're a little too big. You'll set them to be half the current size.

2. Select the *C-Ext01* object. This is the wall object near the right side of the Perspective viewport; it resembles a reversed, squared-off letter C.

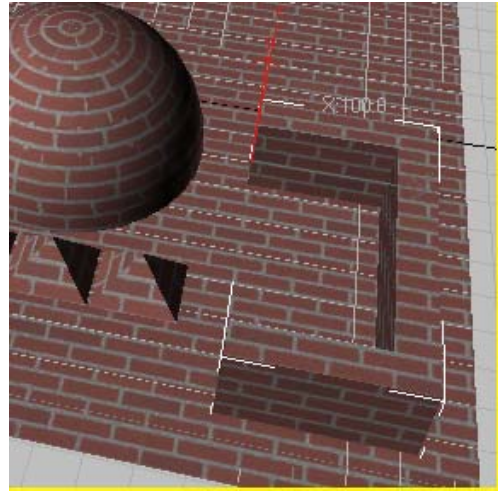

3. On the Modify panel > Parameters rollout, set Scale to **50.0**.

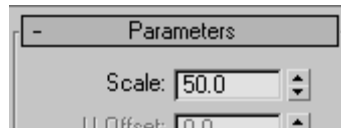

The bricks image shrinks to half its previous size on all objects. This is about right for the scale of the project.

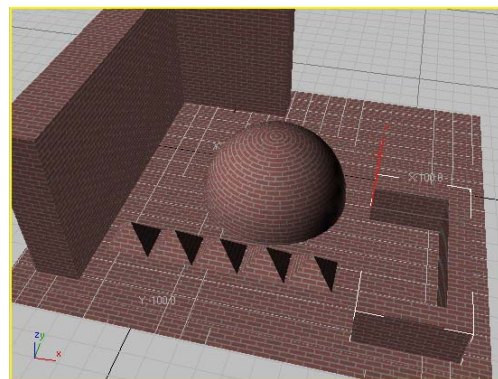

4. On the Modify panel, turn off Wrap Texture.



The brick texture still looks okay on most of the objects, but on the dome it looks irregular. Zoom in for a better look, if you like, and then zoom back out.

Wrap Texture attempts to apply the texture along surface normals, and should generally be left on for best results.

- Turn Wrap Texture back on.

Next you'll see even more dramatically how MapScaler scales the texture uniformly.

- In the modifier stack display, click the light-bulb icon next to *Map Scaler OSM* to turn off the modifier.

All instances of the modifier are turned off, and the texture returns to its original, different scales.

The *C-Ext01* object should still be selected.

- In the modifier stack display, click the C-Ext item to highlight it.

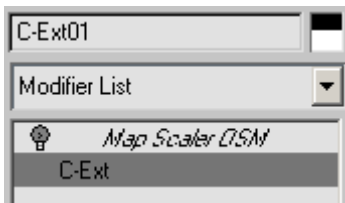

Its parameters appear on the Modify panel.

- Change the Height setting to **60.0**.

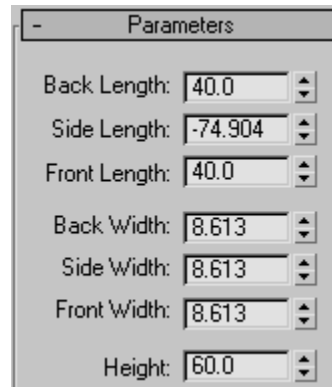

The size of the brick texture on the sides expands along with the wall's height.

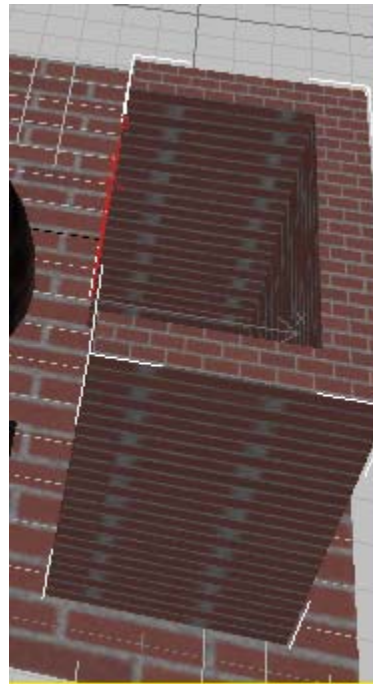

- Turn the modifier back on by clicking the light-bulb icon in the stack display.

The texture returns to its uniform size.

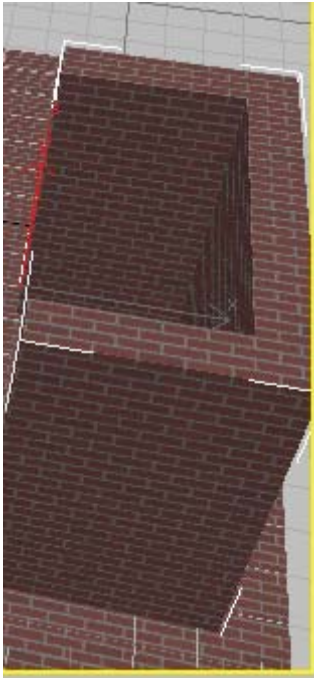

10. Use the Height spinner to increase the *C-Ext01* object's height to **85.0**.

The texture remains the same size as the object expands.

Observe the modifier stack behavior of MapScaler (WSM):

As the final part of this lesson, you'll observe one difference between the object-space and world-space versions of the MapScaler modifier. As you've seen, the instanced object-space version is accessible with any number of objects selected. An instanced world-space version, however, can be accessed only with a single object selected.

1. Press **CTRL+A** to select all objects in the scene.
The modifier stack shows "Multiple Selected," and the only entry in the stack display is the modifier.

2.  Click the Remove Modifier From The Stack button to delete the modifier from all objects.

The texture returns to its original, varied sizes.

3. On the Modify panel, click Modifier List, and from the list choose World-Space Modifiers > MapScaler (WSM).

The software applies the modifier as an instance to all objects, and the map size becomes uniform. However, the modifier doesn't appear in the modifier stack display.

4. Click any object in the scene to select it and deselect all the other objects.

Now the object's name appears in the modifier stack display, along with the modifier as a binding.

The software always includes "Binding" as part of the default name of world-space modifiers in the modifier stack display, because of the way world-space modifiers work.

5. Change the Scale setting to any value.

The size of the brick texture changes throughout the scene, demonstrating that the modifier is instanced on all objects.

6. Click the Remove Modifier From The Stack button to delete the modifier from the selected object.

The texture returns to its original size on the object.

7. Select a different object.

The modifier again appears on the object's modifier stack. As you can see, there's no easy way to remove the modifier from the scene; you'd have to select each object in turn and remove the modifier. In this regard, the world-space version isn't as convenient to use as the object-space modifier. On the plus side, the world-space version allows the texture to

survive changing object size with the Select And Scale tool as well as by changing the object creation parameters, whereas the object-space version functions correctly only in the latter case. We leave it to you to explore this capability as an elective exercise.

Applying Uniform Textures to Complex Objects

In addition to being useful when used on objects of various sizes, the MapScaler modifier is also useful for objects which do not map well with the UVW Map modifier such as curved walls, or roofs with multiple slopes. You will explore the latter in this exercise.

The files for this tutorial are in the *|tutorials|new_materials|* folder.

Open the scene and create the roof:

1. Open the file *|tutorials|new_materials|roof.max*.

The scene shows two splines, one representing the 2D roof layout, the other is a simple line you will need to build the roof in 3D.

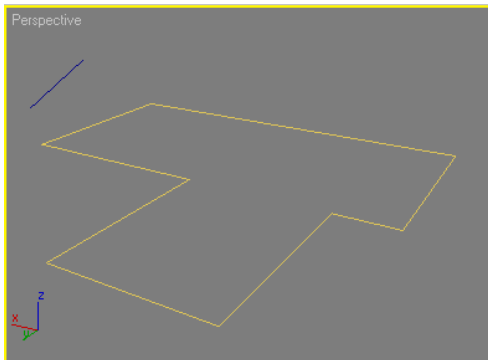

2.  Select the yellow spline named Roof and go to the Modifier panel
3. In the Modifier list, choose Bevel Profile.

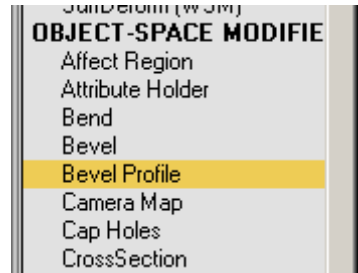

4. In the Parameters rollout, choose the Pick Profile button and then click on the blue line in any viewport.

The 3D roof takes shape but its edges are intersecting in a strange way.

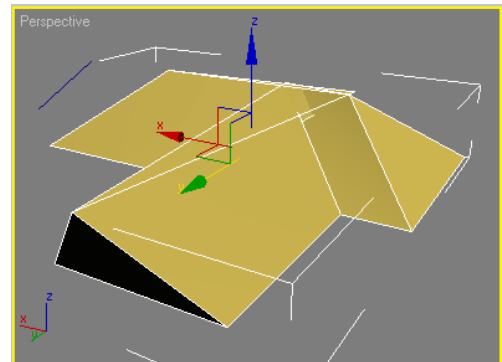

5. With the roof still selected, activate the option: **Keep Lines From Crossing** in the Intersections group.

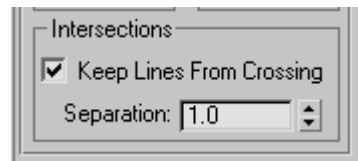

The roof is now displayed correctly.

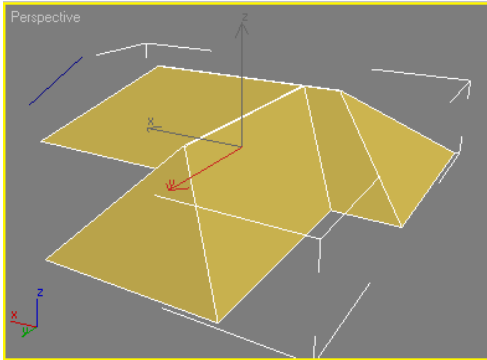

Create and apply a shingles material to the roof:

1. Press **M** to open the Material Editor.
The first material in the upper-left sample sphere is active. You will apply a Diffuse map containing a shingles image.
2. In the Material Editor, to the right of the Diffuse color swatch, click the square button.

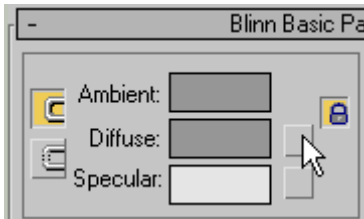

The Material/Map Browser dialog opens.

3. Double-click the Bitmap list entry.
The Select Bitmap Image File dialog opens.
4. navigate to the directory from which you opened the scene file, and then open the shingles.jpg file.

The shingles appear on the sample sphere

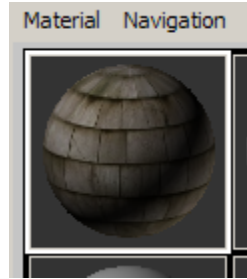

5.  Click the Show Map In Viewport button on the Material Editor dialog.

This lets you see the shingles image in shaded viewports on the roof to which the material is applied.

6. Drag the newly created material from the Material Editor and drop it on the 3D roof in the viewport.

Close the Material Editor when done.

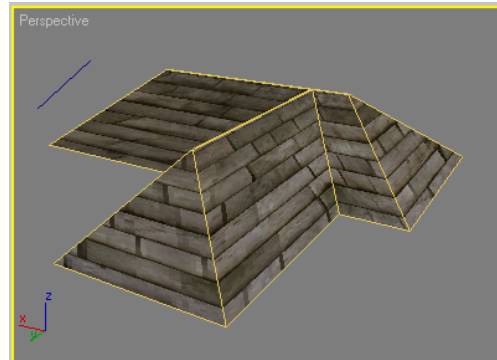

The shingles texture appears on the roof but it is not following any logical pattern.

If you were to apply a UVW Map modifier at this moment, you would notice that none of the map types such as Planar, Cylindrical or Spherical would help in this situation, that is unless you used multiple UVW Map modifiers to account for the different slopes on the roof. It is much easier to achieve the same results using a Map Scaler modifier.

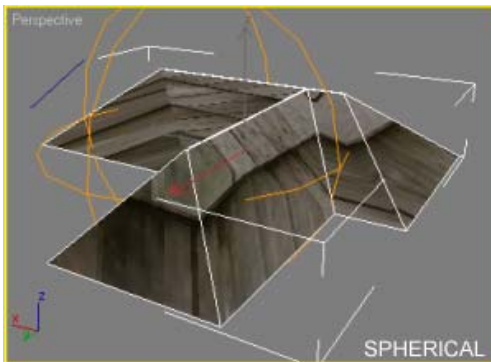
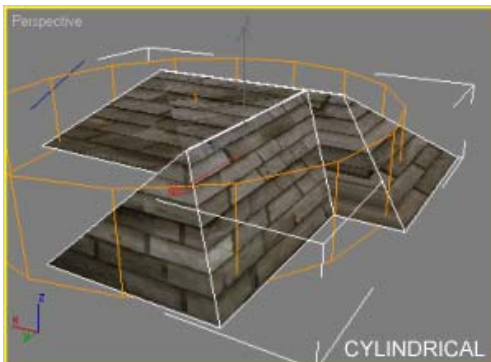
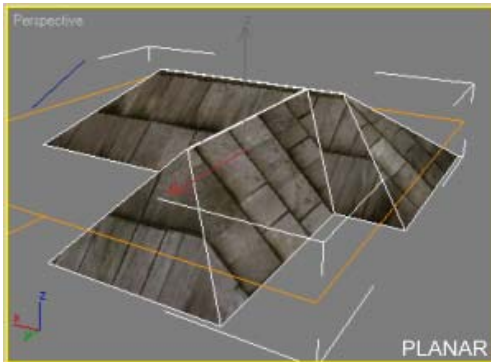

Apply a MapScaler (WSM) modifier to the roof:

1.  With the roof selected, go to the Modify panel.
2. From the Modifier list, choose World Space Modifiers > MapScaler (WSM).

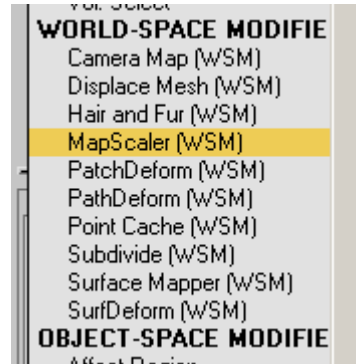

Note: A World-Space Modifier (WSM) modifier is always evaluated last. This means that if you decide to edit the geometry of the roof at a later time, the mapping will remain unaltered

3. Try changing the scale value.

Notice how the orientation of the shingles flows nicely on each slope of the roof.

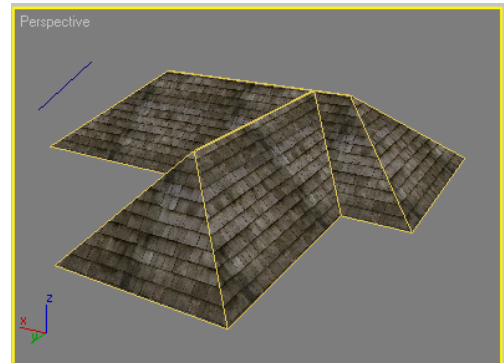

Modify the geometry without altering the texture:

1.  With the roof selected, go to the Modify panel.
2. From the Modifier list, choose Edit Mesh.
Notice that even though you applied the modifier to the top of the stack, it is still listed below the MapScaler modifier and will therefore be evaluated before the WSM modifier.

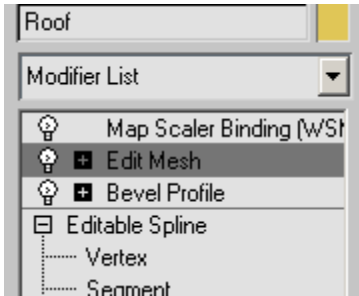

3.  Activate the Show End Results toggle to display the proper mapping in the viewport.
4. Expand the Edit Mesh modifier and choose Vertex.

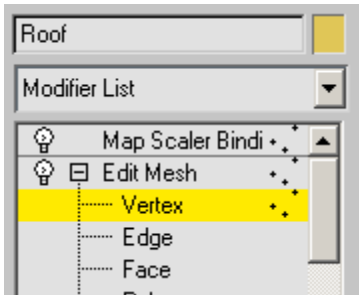

5. In the top view, select the vertices that protrude in the Y-direction and move them back to shorten the roof length.

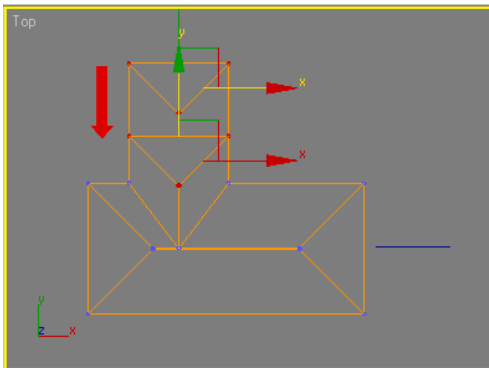

Notice the end result in the perspective view. The shingles scale remains the same as you edit the mesh structure.

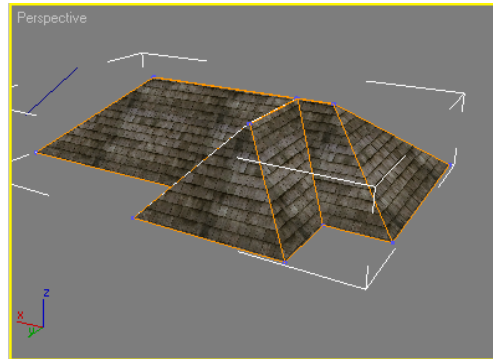
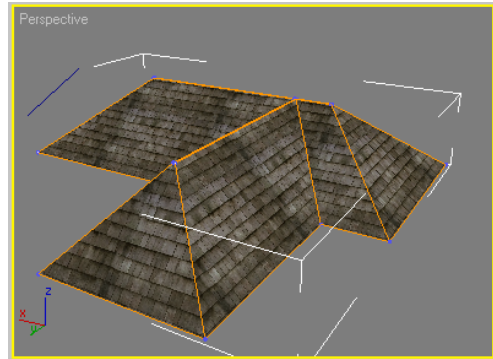

Using the Object-Space MapScaler Modifier

One of the main differences between object-space and world-space modifiers is that the latter always reside at the top of the modifier stack, while object-space modifiers can live anywhere in the stack. Because the stack order is usually important, this gives MapScaler OSM (object-space modifier) version a distinct advantage in situations where some modifiers must be applied after the map-scaling operation. You'll explore this capability in this lesson.

The files for this tutorial are in the `|tutorials|new_materials|` folder.

Open the scene and apply modifiers:

1. Open the file `|tutorials|new_materials|doors.max`.

The scene is of two door objects, to each of which is applied a Multi/Sub-Object material containing a wood bitmap texture on the inner panel.



The texture is too large, so you'll use MapScaler modifiers to reduce its size.

2. Select the left-hand door, *WSM Door*, and, from the World-Space Modifiers category, apply a MapScaler (WSM) modifier. Set Scale to **50.0**.
3. Select the right-hand door, *OSM Door*, and apply an object-space MapScaler modifier. Set Scale to **50.0**, if necessary.



The textures on both doors are scaled to half their original size, and look the same. Note that the selection bounding box of *WSM Door* is aligned with the world, while that of the *OSM Door* object is aligned with the object.

Rotate the textures on the first door:

Say, for some reason, you want the wood texture to be oriented horizontally instead of vertically. To do this, you'll select the polygons that contain the texture, apply a UVW Xform modifier, and then use the latter to rotate the texture.

1. Select the left-hand door, *WSM Door*, and apply a Mesh Select modifier from the Selection Modifiers category.

The Mesh Select modifier appears in the modifier stack below the Map Scaler Binding entry. World-space modifiers always stay at the top of the stack.

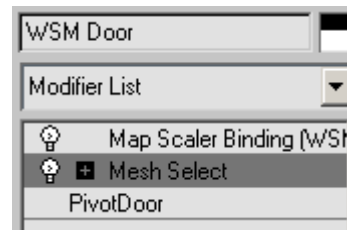

2.  On the Modify panel > Mesh Select Parameters rollout, click the Polygon button.
3. In the Select By Material ID group, set ID to **3** and then click the Select button.

This selects the panel polygons on the front and back sides of the door. If it's not evident that they're selected, press **F2** to turn on Shade Selected Faces.

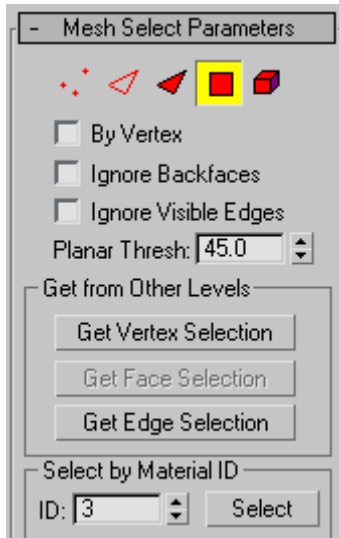

4. Apply a UVW Xform modifier to the door.

This modifier lets you change the texture orientation. Again, the MapScaler remains at the top of the stack.

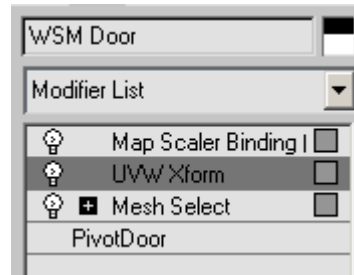

5. On the Parameters rollout, turn on Rotate About Center, and then set Rotation to **90.0**.

Nothing happens to the texture image on the door. This is because the world-space MapScaler modifier is applying its own texture coordinates at the top of the stack, overriding the texture coordinates applied by the UVW Xform modifier. You can confirm this by turning off the Map Scaler Binding item in the stack (click its light-bulb icon). If you do, note that the texture is now rotated but is back to the too-large size, and then turn the Map Scaler Binding back on.

Rotate the textures on the second door:

1. From the modifier stack display, drag the Mesh Select modifier from the modifier stack onto the *OSM Door* object in the Perspective viewport.

The second door is now selected, along with its textured polygons, and the Mesh Select modifier appears at the top of its stack, above the Map Scaler OSM entry.



- In the modifier stack display, click the Mesh Select modifier entry, currently highlighted in yellow, to exit the sub-object level.

This is necessary in order to be able to select a different object.

- Select the *WSM Door* object again, and then drag its UVW Xform modifier onto the *OSM Door* object in the viewport.

The UVW Xform modifier appears at the top of the *OSM Door* object's stack. Because it takes effect after the MapScaler modifier, you can see its rotation of the texture.

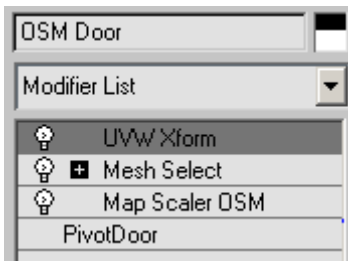

The texture, still the correct size, is now rotated 90 degrees, according to the Rotation adjustment you made previously in the UVW Xform modifier.



- Try changing the UVW Xform modifier's Rotation setting using the spinner; the texture orientation changes in real time. Also click the Map Scaler OSM stack entry and use the

spinner to change the Scale value. Again, you'll see it change in real time.

Summary

In this tutorial, you learned about the useful ability of both MapScaler modifiers to unify texture scale throughout your scene with a single setting. You also learned some of the differences between the two versions, including the accessibility in the stack of an instanced OSM version with multiple objects selected, and its ability to live anywhere in the stack.

Managing Texture Coordinates



This tutorial looks at some of the 3ds Max features related to materials, texturing, and rendering. The first lesson, in three parts, covers functionality in the Unwrap UVW modifier. Following this are lessons on Render To Texture, the Ink 'n Paint material, and the Translucent shader.

Skill level: Intermediate

Time to complete each lesson: 30–60 minutes

Features Covered in This Tutorial

In these lessons you will learn:

- Using the Unwrap UVW modifier.
- Using Render To Texture to “bake” lighting, shadows, and other scene features into a bitmap texture for use in games and other real-time applications.
- Using Ink ’n Paint to render comic-style images.
- Using the Translucent shader to simulate translucent materials

Tutorial Files

All the necessary files to do the tutorials can be found on the Tutorial Files CD, in the *|tutorials|materials_and_rendering* folder. Before doing the tutorials, copy the *|tutorials* directory from the CD to your *|3dsmax8* local installation.

Using Unwrap UVW, Part 1

In this three-part lesson, you’ll get an introduction to the Unwrap UVW modifier, and use several of its features.

Note: All the necessary files to do the tutorials can be found on the Tutorial Files CD that ships with 3ds Max 8. Before doing the tutorials, copy the *|tutorials* directory from the CD to your *|3dsmax8* local installation.

Examine the final mapping:

You’ll start by looking at the final version of a fairly detailed object mapped with the Unwrap UVW modifier.

1. Open the file *tut_unwrap_start.max*.

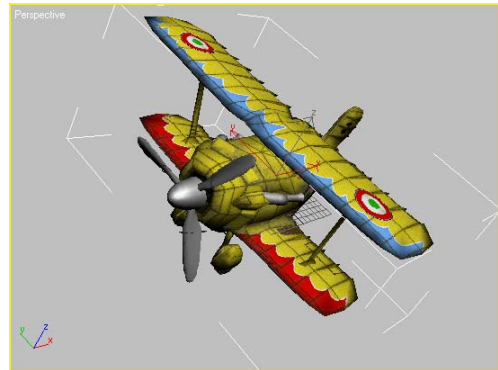

2. Go to the Modify panel and select the Fuselage object; just click a wing. You can now see the object’s modifier stack, with the Unwrap UVW modifier applied to the Editable Poly object.
3. In the modifier stack display, click Face to access this sub-object level. Also, in the Selection Parameters rollout, turn on Select By Element.

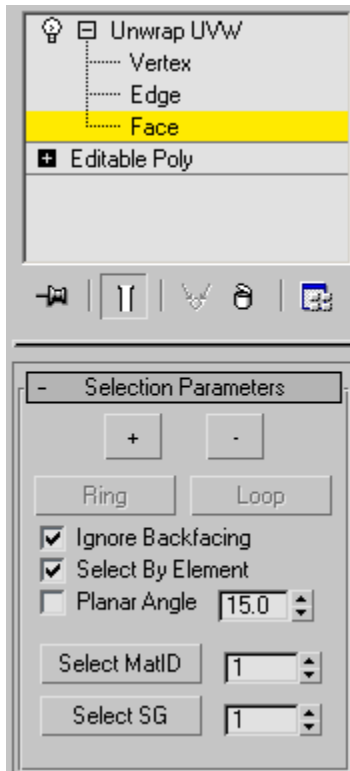

This will let you select large sections of the Fuselage, rather than single faces.

4. On the Parameters rollout, click Edit.

This opens the Edit UVWs dialog, also known as the UVW editor.

5. In the drop-down menu at the top right of the window, choose *biplane_texture.jpg*.

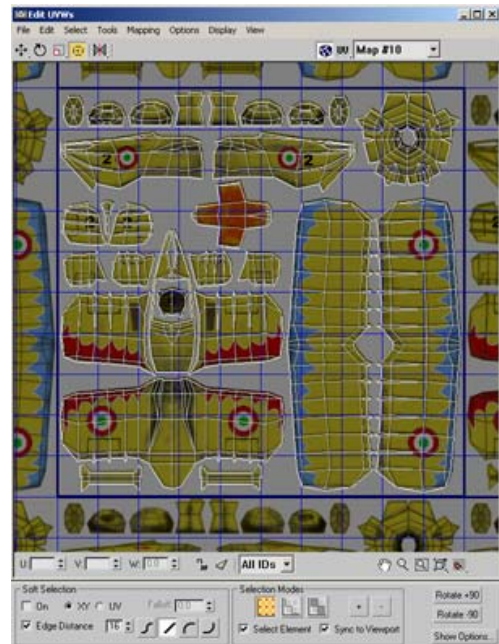
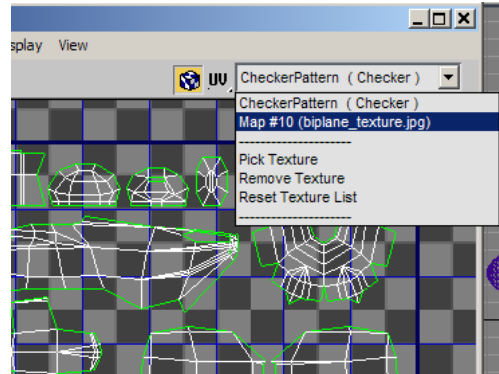

You can now see the UVW clusters laid out against the texture map in the background. Each cluster represents a section of the Fuselage geometry that is planar-mapped with the underlying area of the bitmap texture.

6. In the Perspective viewport, click the upper wing.

The entire wing is selected, and in the editor window, the UVW clusters assigned to it become highlighted.

7. Still in the viewport, click different parts of the Fuselage to see which UVW clusters correspond to them.

Highlighting a cluster makes it easier to see how well its outline matches the shape of the underlying section of the texture map. You can also use the Options button to change the wireframe color used by the clusters. Also, it often helps to lower the bitmap brightness as well.

Most of the Fuselage parts are combined into a single element, which uses the clusters on the left side of the editor window.

8. In the viewport, select the nose cone (it's right behind the propeller), and note the cluster that highlights in the editor.

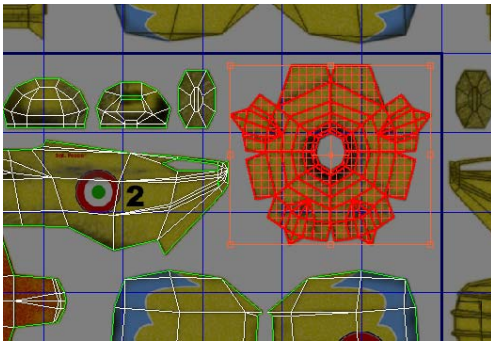

The nose cone is mapped as a single piece, which is convenient to texture with a single area of the bitmap. It's not really flat, but the planar mapping works with it because of the UVW editor's ability to closely match the geometry with the bitmap on a per-vertex basis.

9. Next, click one of the landing gear housings, and note how it's mapped with four different clusters.



10. Click an empty area of the editor window to deselect the UVW clusters.
11. In the editor, turn on Selection Modes group > Select Element, if necessary, and click each of the previously highlighted clusters in turn to see which part of the housing it maps. You might need to rotate the viewport to see the highlighted polygons. If you still can't see the selection, press F2 and/or F4 to enable Shade Selected and Edged Faces, respectively. Also, the outermost cluster corresponds to the inside of the wheel housing, so it might be a bit difficult to spot at first.

Because the housing structure is more complex than that of the nose cone, it makes sense to map it with four clusters instead of one.

Ultimately, it's up to you how you map your geometry; the UVW editor gives you the power and flexibility to use the method that works best for you.

Using Unwrap UVW, Part 2

In this section, you'll examine Unwrap UVW's Flatten Mapping command for automatic mapping.

Use Flatten Mapping:

1. Click an empty area of the editor window to deselect any selected UVW clusters.
2. In the Edit UVWs dialog, open the Mapping menu and choose Flatten Mapping.

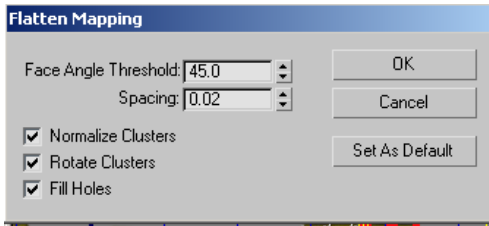

The Flatten Mapping dialog opens.

3. Click OK to accept the default settings and remap the Fuselage using this automatic mapping function.



The software applies planar mapping to each section of the mesh based on the Flatten Mapping dialog settings. The editor now displays a very different set of UVW clusters. Each cluster consists of a set of contiguous faces in which the angle between neighboring faces is less than or equal to the Face Angle Threshold setting in the Flatten Mapping dialog.

The main difference is that there are many more clusters, and most of them are smaller than in

the final. The wings are relatively flat, so their clusters are easy to identify, but most of the rest are not. You can remedy this somewhat by increasing the angle threshold.

Of course, the underlying texture map remains the same when you change the mapping. If you look at the Perspective viewport, you can see that the mapping is now much different than before.

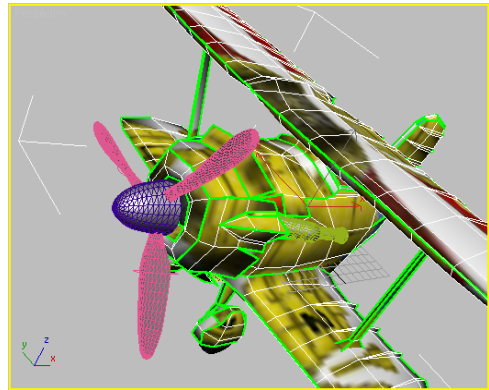

4. Again choose Mapping menu > Flatten mapping, and for Face Angle Threshold, type **61** (this is the angle used by the artist as a first step in creating the final mapping). Click OK to perform the remapping.



The result is fewer clusters than before, but still many more than in the final. In the next procedure, you'll look at a couple of ways of combining these clusters.

Combine the UVW clusters:

You can use the editor's Stitch function to combine clusters one at a time, and the modifier's Planar Map command lets you combine several clusters simultaneously.

1. In the viewport, select the nose-cone element.

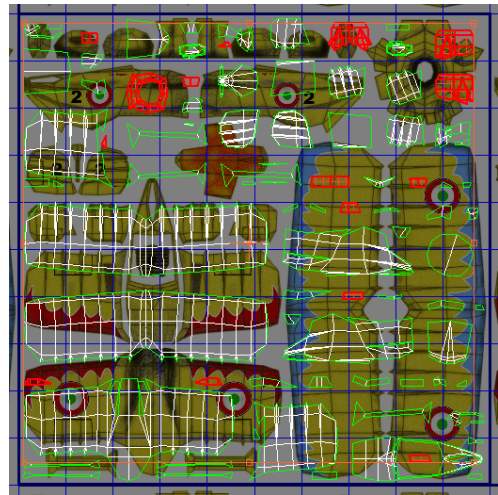

This causes all of the UVW clusters used by the nose-cone geometry to highlight in the editor.

2. On the editor's lower toolbar, click the Filter Selected Faces button to turn it on.



Now only the highlighted clusters appear.

3. Click outside the bounding box to deselect everything, and then click a vertex on one of the smaller clusters to select the cluster.

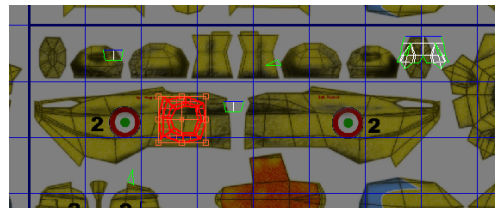

Highlighted edges and vertices appear on one or more other clusters to show the sub-objects shared with the selected cluster.

- In the Tools menu, choose Stitch Selected.

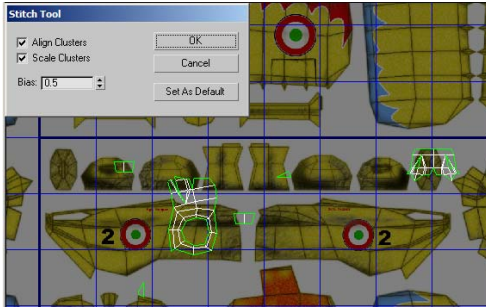

The Stitch Tool dialog appears, and one of the other clusters moves next to the selected clusters, with the shared sub-objects “stitched” together. The software automatically stitches the cluster with the most shared sub-objects; if two or more share the same number of sub-objects, it picks the one with the lowest vertex ID numbers. In this case, it picked the rightmost cluster near the top of the editor window.

- In the dialog, click the Align Clusters check box to turn it off, note what happens, and then click it again to turn it back on.

When you turn off Align Clusters, the attached cluster moves back to its original position. Use this when the automatic alignment positions the attached cluster in an undesirable way, such as overlapping the first cluster.

- Click OK to close the dialog.
- Next, you’ll use Planar Map to combine all of the nose cone clusters at once.
- In the viewport, select the nose cone element.
- In the Modify panel > Map Parameters rollout, click Planar.

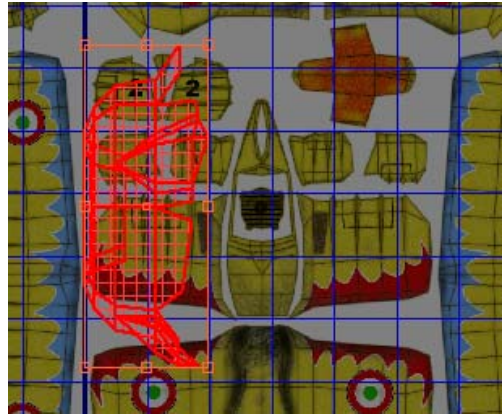

The Planar button turns yellow and the clusters combine into a single cluster that’s roughly the shape of the nose-cone texture in the upper-right section of the bitmap. But the cluster is oriented differently than the texture, and is much bigger.

- In the Map Parameters rollout, click on Align X. This will reorient the mapping gizmo so that it is perpendicular to the nose cone element.

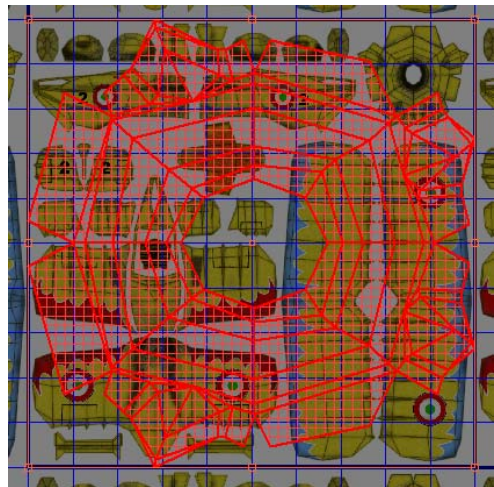

- Near the bottom-right corner of the Edit UVWs dialog, click the Rotate -90 button to match the orientation.

11. In the Modify panel > Map Parameters rollout, click Planar again to exit Planar Mapping mode.

12.  Use the Freeform Mode transform tools to fit the cluster to the nose-cone texture. Drag the corners of the bounding box to scale the cluster, and drag within the bounding box to move it. Check your work in the viewport, and render if you like.

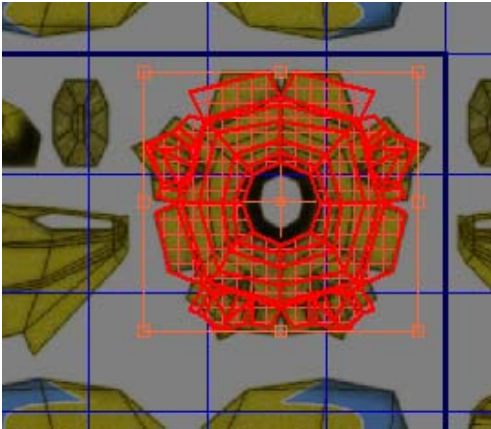

To get an exact match, you'd have to move the vertices as well. You can improve the match somewhat using the Sketch Vertices command, which we'll cover in the next lesson.

Tip: You can use the Edit UVWs dialog to make a template for creating your own texture maps. Once you've got the clusters set up the way you want them, go to the Tools menu and choose Render UVW Template, and then use the Render UVW Template button to generate a flattened 2D image of the mapping coordinates. You can then save and open the bitmap image into your Paint application (such as Adobe Photoshop). Use the cluster outlines as a guide for painting the texture map.

Using Unwrap UVW, Part 3

Add a menu item:

To use Sketch Vertices, you need a selection of vertices. The UVW editor gives you a variety of ways of making the selection, including several built into the Sketch Vertices tool. You'll try one of the easiest, but it will require a bit of setup. In this procedure, you'll add a menu item to the editor that will let you choose an entire cluster outline with one click.

1. From the 3ds Max menu bar, choose Customize > Customize User Interface
2. Click the Menus tab, and then, from the Group drop-down list, choose Unwrap UVW.
3. From the drop-down list above the right-hand column, choose UVW Unwrap - UVW Select.

This is the Select menu in the Edit UVWs dialog.

4. In the left-hand list, scroll down until you see Open Edge Mode. Drag this item to the right-hand list, just above the End Of Menu item.

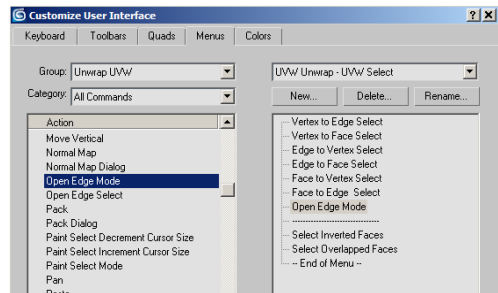

Tip: While you're at it, you might also want to add Open Edge Select. This works on an existing selection, selecting all outer edges of any clusters that have any outer edges selected.

5. Close the Customize dialog by clicking the X box in the upper-right corner.

6. Close the editor window the same way, and then reopen it by clicking Parameters rollout > Edit.

This refreshes the editor interface, implementing the change you made.

Select the outer UVW vertices:

You'll use the newly added command to select the cluster outline, and then convert the edge selection to a vertex selection.

1. Use Zoom Region to zoom in on the nose-cone section of the editor window.
2. On the Options panel (docked to the bottom of the Edit UVWs dialog), in the Selection Modes group, choose Edge Sub-object Mode and turn off Select Element.



3. Click a point inside the dialog to deselect all edges.
4. From the Select menu, choose Open Edge Mode.

With this turned on, selecting an outer edge (or one adjacent to an outer edge) selects the entire outline.

5. Click one of the cluster's outer edges.

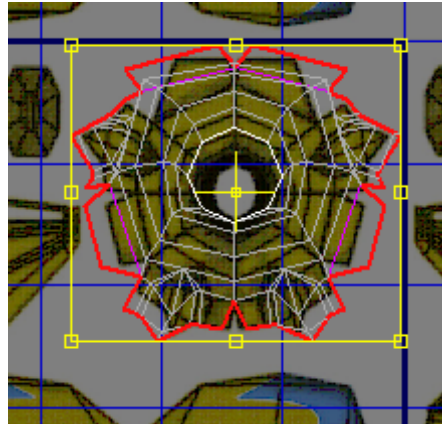

The entire outline highlights to indicate all outer edges are selected.

6. From the Select menu, choose Convert Edge To Vertex.

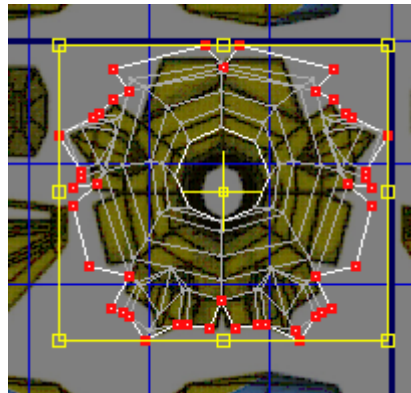

All outer vertices of the cluster are selected.

Sketch the vertices:

1. From the Tools menu, choose Sketch Vertices.
2. In the Sketch Tool dialog, from the Select By drop-down list, choose Use Current Selection.
3. Make sure Align To is set to Free Form, and that Show Vertex Order is turned on. Also, if Interactive Mode isn't turned on, turn it on.
4. Click OK to exit the dialog.

You're now in Sketch mode. The selected vertices are numbered in the order that they'll be drawn.

5. Examine the vertices closely, starting with the first one (number 0).

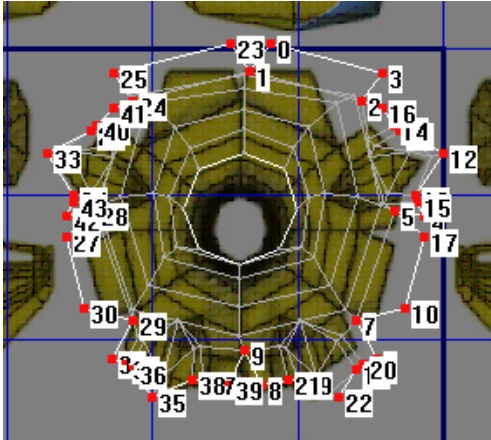

There's a problem: They're not numbered in order, so the shortcut won't work in this case. But at least you added a useful command to the Select menu.

When using Sketch Vertices, always make sure the selected vertices are numbered in the exact order you intend to draw them, otherwise you can end up with a mess.

6. Right-click in the editor window to exit Sketch Vertices mode.
7. Zoom in as far as possible, so the nose cone fills the editor window, and then choose Sketch Vertices again from the Tools menu.

In this case, you want to pick only vertices on the outside edge of the cluster; zooming in helps ensure that you don't inadvertently pick internal vertices.

8. This time, in the Sketch Tool dialog, choose Select By > Drag Selection. Leave the other settings as they are, and click OK.

The mouse cursor turns into a circle, indicating that you're in Drag Selection mode. Don't worry if the vertex numbers show; they'll go away as soon as you start dragging.

9. Position the cursor over the top-center vertex. While pressing the mouse button, drag around the entire outline.

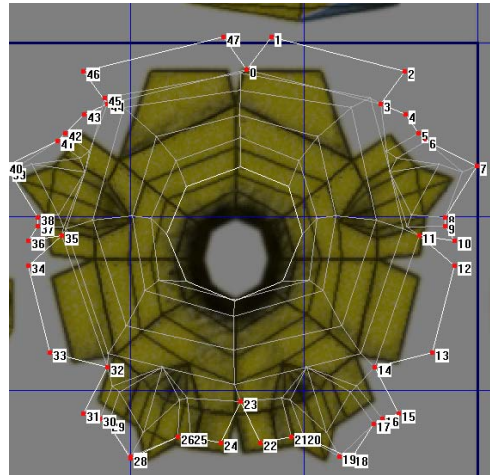

The vertices highlight as you drag over them, and this time they're numbered in the correct order.

When you release the mouse button, the cursor turns into a pencil, indicating that you're ready to start sketching.

10. Position the mouse over the top-center of the nose-cone texture, at the bottom of the V, and press and hold the mouse button.
11. Drag around the entire outline of the nose-cone texture, following the edges as closely as you can.

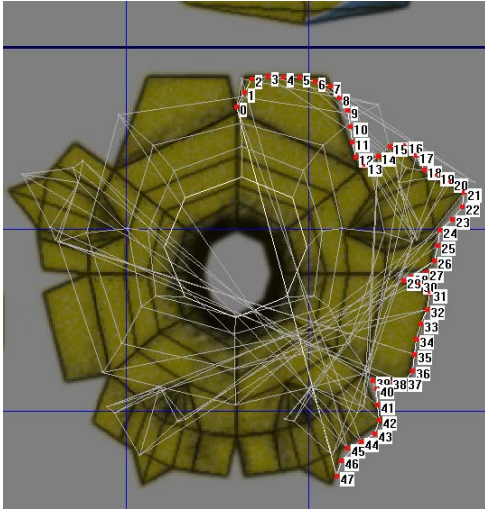

As you drag, the vertices spread out along the outline you draw.

As you can see, Sketch Vertices/Free Form is best used for matching vertices to bitmaps with curved outlines. With the other Align To options, you can also match straight-line, circular/oval, and rectangular outlines. The purpose here was primarily to introduce you to the tool; in this situation, you'd probably get a better match after doing the planar mapping simply by moving vertices one at a time.

Check the original again:

- To finish, load the *tut_unwrap_start.max* file and examine its mapping again. Try flattening its mapping again, and see how closely you can match the texture map with your own mapping methods.

Summary

The Unwrap UVW modifier is a powerful tool for applying complex mapping to your objects. This tutorial covered a variety of methods for using the modifier, including how to coordinate selection of UVW coordinates and parts of the

object, usage of the automatic mapping tools such as Flatten Mapping, combining mapping clusters, and sketching vertices.

Using the Relax Tool on Texture Coordinates

An important tool in the [Unwrap UVW modifier](#) editor is Relax, which algorithmically spreads out texture coordinates to give more even coverage of the underlying texture. This makes it easier to assign specific texture coordinates to the desired areas of the texture. This tutorial gives you a brief look at how to use Relax in a specific texturing application.

Skill Level: Intermediate

Time to complete: 20 minutes

Features Covered in This Tutorial

In this tutorial you learn:

- Applying a Unwrap UVW modifier.
- Using the Relax tool to affect texture coordinates.

Tutorial Files

All the necessary files to do the tutorials can be found on the Tutorial Files CD, in the *|tutorials|materials_and_rendering* folder. Before doing the tutorials, copy the *|tutorials* directory from the CD to your *|3dsmax8|* local installation.

Procedures

Set up the tutorial:

- From the *tutorials|materials_and_rendering* directory, load the scene file *clown_head.max*.

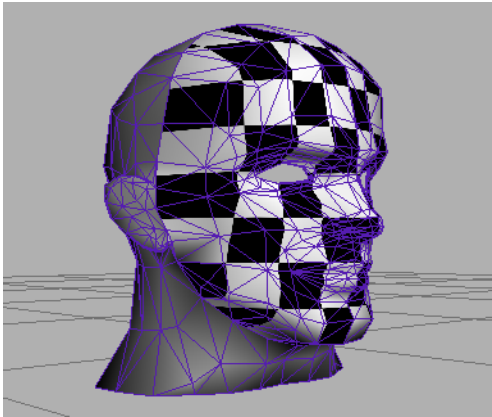

The scene contains a model of a head, with a UVW Map modifier set to Planar applied to the face. Also applied to the face is a material with a Checker map. The map helps show where the texture vertices might need to be adjusted.

Apply the Unwrap UVW modifier:

1. Select the head object and go to the Modify panel.
2. Apply an Unwrap UVW modifier.

The Unwrap UVW modifier appears at the top of the stack, but doesn't provide a sub-object mode because you're applying it to an existing sub-object selection.

Edit the UVW mapping:

1. On the Parameters rollout, click the Edit button.
The Edit UVWs dialog opens.

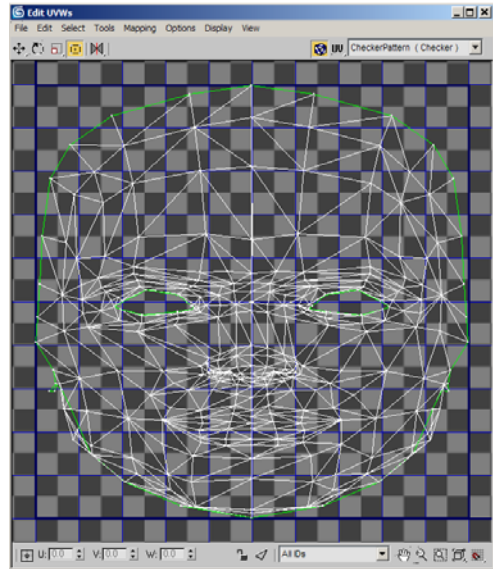

Only the selected parts of the mesh appear, and all texture vertices are selected.

Note that the texture vertices are most dense around the detailed parts of the face: the eyes, nose, and mouth. This is where you can use Relax to spread out the vertices for easier manual editing.

2. Drag a selection region around the eyes.

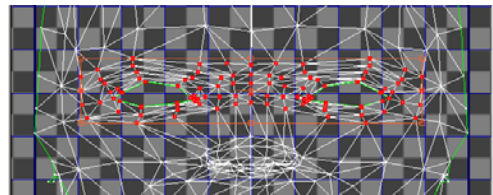

3. From the Edit UVWs dialog menu bar, choose Tools > Relax dialog.

The Relax Tool dialog appears.

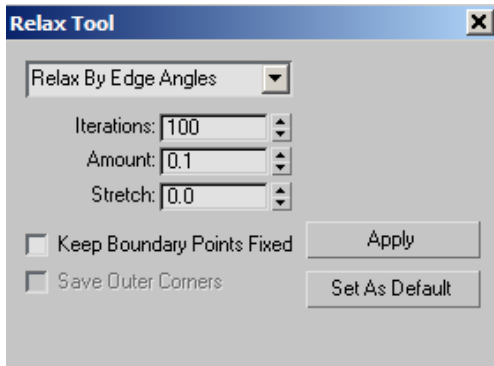

The Relax Tool dialog is modeless. It offers different algorithms to relax the mapping. The default mode, Relax By Edge Angles is often recommended as it minimizes the overlapping of edges.

- Click the Apply button twice.

The selected vertices move apart slightly.

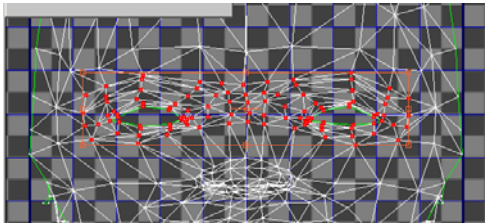

- Similarly, use Relax on the vertices around the nose and mouth.

Summary

The Relax tool in Unwrap UVW can save you time and effort by automatically spreading out mapping vertices. In some cases, you'll need to follow up by moving vertices to the desired final locations.

Using the Channel Info Utility

This tutorial shows a number of different methods for using the [Channel Info utility](#). This is an intermediate-level tutorial; you should be familiar

with standard 3ds Max procedures such as creating and applying materials.

Skill level: Intermediate

Time to complete: 90 minutes

The files for this tutorial are in the *tutorials\materials_and_rendering* folder.

Note: All the necessary files to do the tutorials can be found on the Tutorial Files CD that ships with 3ds Max 8. Before doing the tutorials, copy the *tutorials* directory from the CD to your *13dsmax8* local installation.

Reduce a mesh object's memory footprint:

When working as a 3D artist on a game-development project, you might receive models to work on that have already been mapped, but it's difficult to tell what the mapping is. In addition, the mapping might have been applied inefficiently, so that it takes up more memory than necessary in the model's data structure. This lesson shows you how to use Channel Info to adjust a model's mapping, thus recovering the unused memory, which can then be used by other game assets.

- Open the *ostrich.max* scene file.
- Apply a [UVW Map modifier](#) to the ostrich model. Set Map Channel to 4.

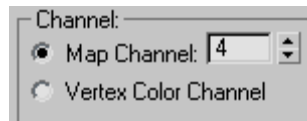

- [Collapse](#) the ostrich object's stack; this results in an Editable Mesh object.

This simulates a situation you might encounter as a 3D artist working for a commercial game developer: You receive a mesh object to work on that already has mapping applied, but you don't have direct access to the tool (modifier) originally used for applying mapping, and

you need to minimize the object's memory footprint for embedding into the game.

4. Create a standard material with a Checker map applied as a Diffuse map. For the Checker map, set U and V Tiling both to **4.0**, and set Map Channel to **4**.



5. Turn on Show Map In Viewport, and apply the map to the ostrich model.

The map appears on the model, mapped in a planar manner parallel to the world grid.



6. Go to the Utilities panel, click the More button, and then double-click Channel Info to open the utility. On the Utility panel, click the Channel Info button.

The Map Channel Info dialog opens:

Object Name	ID	Channel Name	Num Verts	Num Faces	Dead Verts	Size (KB)
ostrich	mesh	-none-	1524	2624	0	741b
ostrich	vsel	-none-	1524	2624	0	61b
ostrich	-2:Alpha	-none-	0	2624	0	33b
ostrich	-1:Illum	-none-	0	2624	0	33b
ostrich	0:vc	-none-	0	2624	0	33b
ostrich	1:map	-none-	0	2624	0	33b
ostrich	2:map	-none-	0	2624	0	33b
ostrich	3:map	-none-	0	2624	0	33b
ostrich	4:map	-none-	1524	2624	0	52b

The dialog lists all pertinent channel information for the object. This is described in detail in the [Interface section](#).

The last channel, whose ID is “4:map,” represents the mapping you applied with the UVW Map modifier. It's preceded by three empty map channels, each of which contributes about 33 kilobytes to the object's memory footprint. These were created because the software requires consecutive numbering of map channels, but the memory isn't being used for anything.

You'll use the Channel Info tools to remove the empty channels, thus freeing up the unused memory. But first you'll copy the mapping to the first available mapping channel, because you can delete channels only starting with the last one.

7. Right-click the last channel, and from the right-click menu, choose Copy.

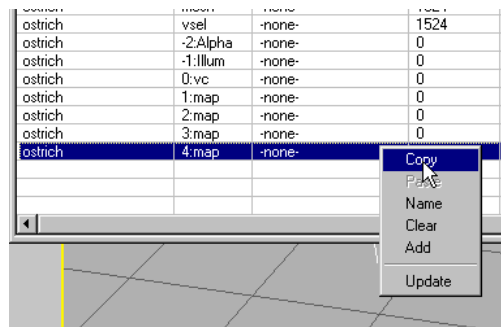

This places the texture mapping created by the UVW Map modifier into the copy buffer. The

status line on the dialog, beneath the row of buttons, reads “Copy Buffer Info: Node: ostrich Map Channel 4”.

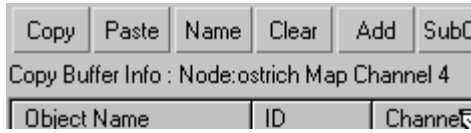

- Right-click the channel whose ID is “1:map” (the first available texture map channel), and, from the right-click menu, choose Paste.

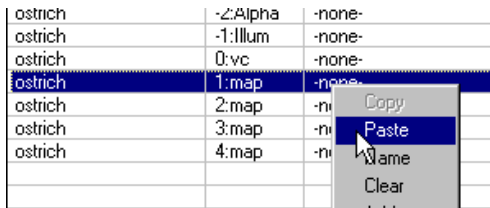

The Channel Name dialog appears, giving you the opportunity to name the pasted channel.

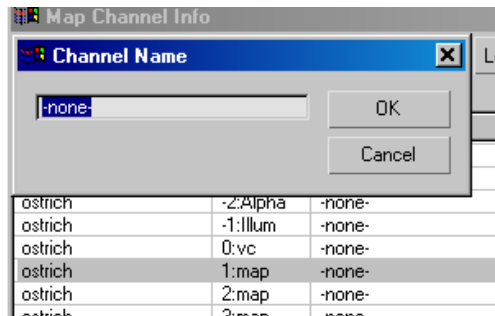

- Type **Planar Mapping** and press ENTER or click OK.

Map channel 1 now also contains the planar mapping originally applied to channel 4. You can now delete the remaining map channels, but first you’ll demonstrate that the planar mapping is indeed applied to channel 1.

Note: With an object that has default mapping, such as a geometric primitive, you might have pasted to channel 2 instead. This would

preserve the original, default mapping as well as the planar mapping in two different channels.

- Open the Material Editor, if necessary, and go to the material’s diffuse map level. Use the Map Channel spinner to decrement the value to 1 by clicking the down arrow three times.

At map channels 3 and 2, no map appears on the ostrich model, because those channels don’t contain any mapping values. But at map channel 1, the checker texture reappears on the object.

- Right-click the 3:map channel, and from the right-click menu, choose Clear.

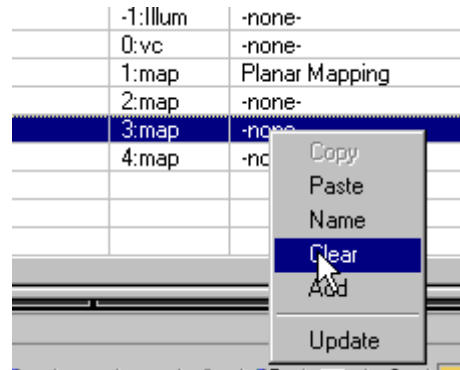

The channel remains, and still uses 33 kilobytes of memory. This demonstrates that you can’t delete intermediate channels.

- Right-click the 4:map channel, and from the right-click menu, choose Clear.

The channel disappears.

- Clear the 3:map channel, and then the 2:map channel.

Only map channel 1 remains. You’ve deleted the others, thus reducing the object’s total memory footprint by approximately 99 kilobytes (the memory consumed by the three unused map channels).

14.  On the Modify panel, look at the object's modifier stack. It contains a UVW Mapping Paste and four UVW Mapping Clear modifiers; the Channel Info utility uses these modifiers to help do its work. To get rid of these, simply collapse the stack.

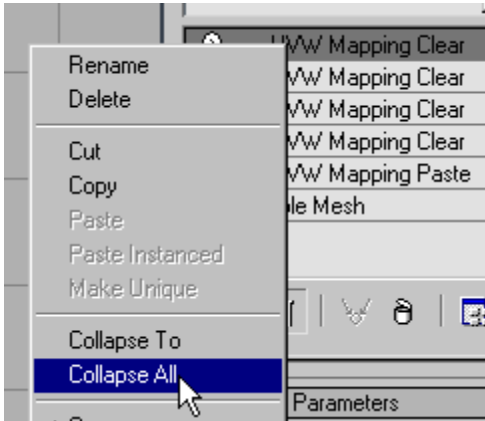

Enable vertex sub-object selections to survive topology changes and object type changes:

Because Channel Info provides access to the channel that stores the current vertex selection, and lets you copy that information to other channels, you can store the vertex selection. Once you've done so, the vertex selection will survive topology changes, such as adding mesh resolution and even changing the object type.



It's important to remember, however, that the vertex-selection channel has only one component, while map channels have three. Thus, you need to copy the vertex-selection channel to a subcomponent of a map channel.

This lesson also demonstrates usage of the [Select By Channel modifier](#) in conjunction with Channel Info.

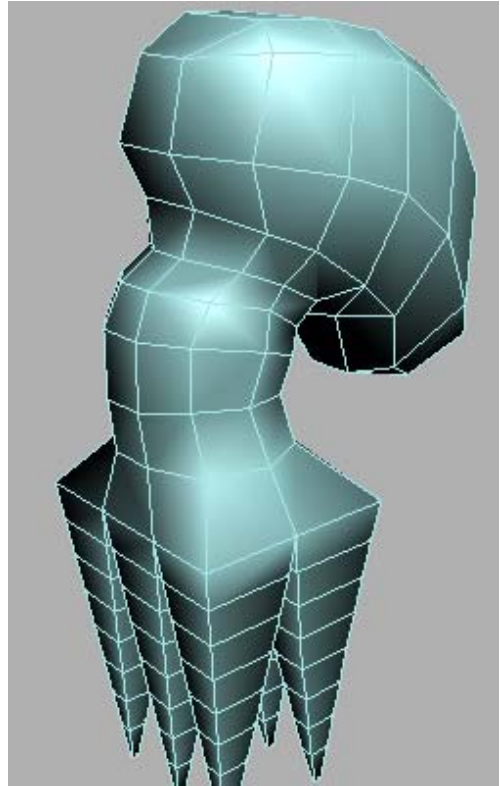
1. Open the *octopus.max* scene file.



This octopus is at an early stage of modeling. You'll use it to learn how to retain sub-object selections after subdividing the mesh.

2. Select the *octopus* object, open the Channel Info utility, click one of the tracks, and then click Add to create a new map channel.
You can use the extra map channel to store the vertex-selection data, thus retaining any information already in the original map channel.
3.   On the Modify panel, go to the Vertex sub-object level of the Editable Poly base object.
4.  From the Region Selection flyout on the toolbar, choose Lasso Selection Region and, in

the Left viewport, select all the vertices in the octopus head. Drag out an approximate region selection; you needn't be particularly careful about not selecting non-head vertices for this exercise.

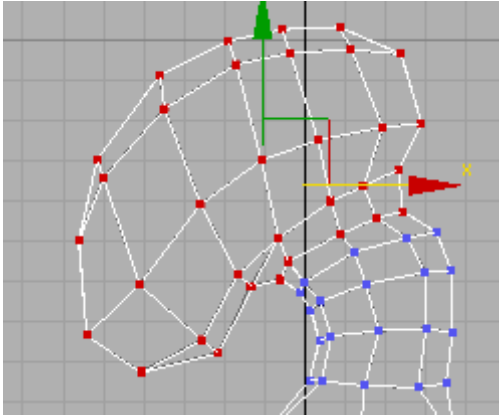

Next, you'll determine whether this selection can survive a topology change on its own. You can use a special feature of Editable Poly to automatically convert the vertex selection to a polygon selection.

-  On the Selection rollout, CTRL+click the Polygon button to go to that sub-object level while simultaneously selecting the polygons used by the existing vertex selection.

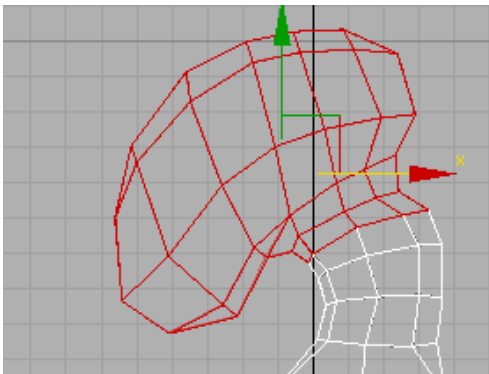

- On the Edit Geometry rollout, click the Tessellate button, and then return to the Vertex sub-object level.

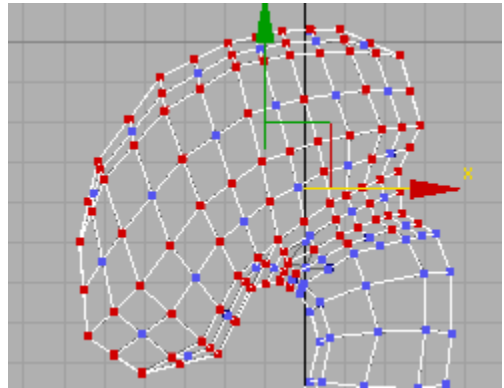

The vertices you selected before are interspersed with the new, unselected vertices that were created by tessellating the mesh. The vertex selection did not survive the topology change. That is, not all of the head vertices are still selected.

- Press CTRL+Z to undo the tessellation.

The software restores the original vertex selection.

- In the Map Channel Info dialog, right-click the vsel channel and choose Copy.

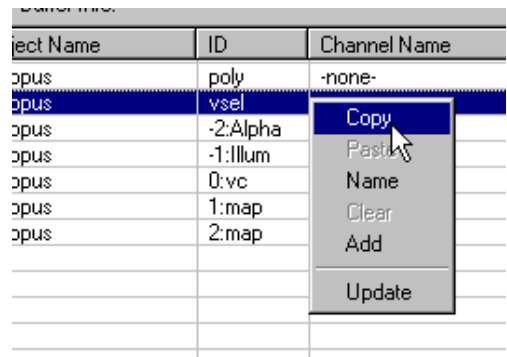

“vsel” is short for vertex selection. This channel stores the current selection set of vertices.

9. Right-click the 2:map channel you created in step 2.

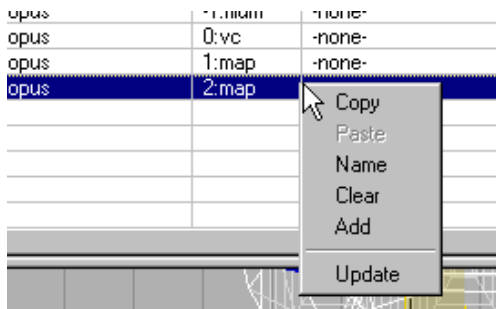

The Paste command is unavailable, because map channels each have three components, but the vertex-selection channel has only one. You can't copy and paste between a one-component channel and a three-component channel. Fortunately, Channel Info gives you optional access to individual components of three-component channels.

10. At the top of the Map Channel Info dialog, click the SubComp (subcomponents) button.

All three-component channels expand into their subcomponents. `vsel` is the only one-component channel.

11. Right-click the 2:map:X channel and choose Paste. When the Channel Name dialog opens, type **Head Vertices** and press ENTER.

The software adds a UVW Mapping Paste modifier to the object's stack.

12. Return to the Editable Poly > Vertex sub-object level, and select all of the octopus's leg vertices.

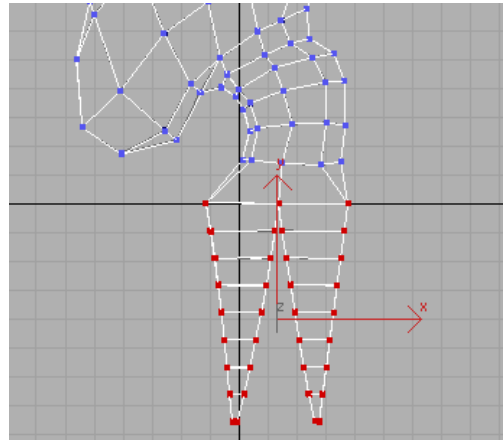

13. Copy the `vsel` channel to the 2:map:Y channel, and name it **Leg Vertices**.
14. In the modifier stack, right-click one of the UVW Mapping Paste modifiers and choose Collapse All.

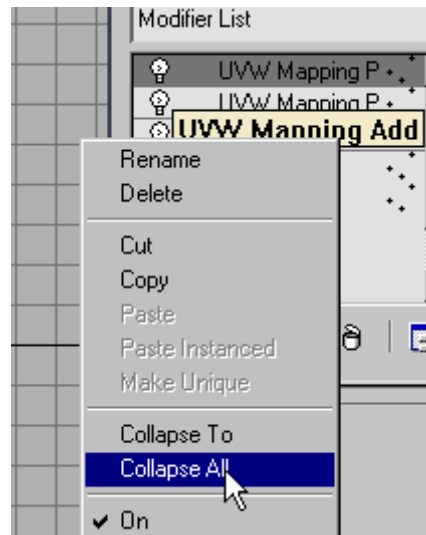

All of the additional modifiers are deleted, and the pasted data is "baked" into the object mesh.

15. Apply a Tessellate modifier to the model.

The mesh resolution increases significantly.

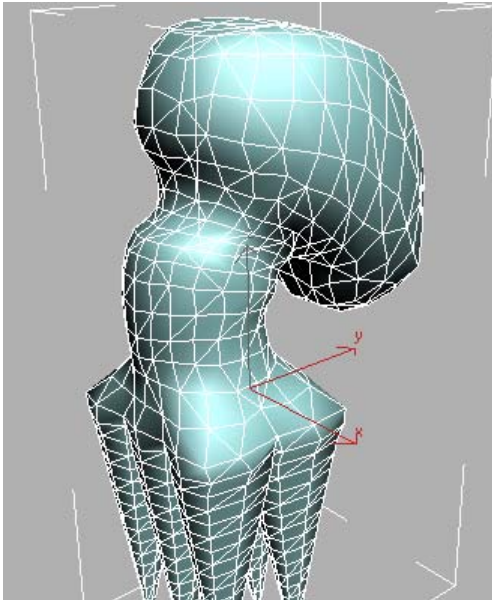

- 16.** Apply a Select By Channel modifier to the octopus model.

This modifier lets you select channels that you named in Channel Info.

- 17.** In the Select By Channel modifier, open the Selection Channel drop-down list.

The entries are the same as the vertex selections you copied and pasted to the map channel subcomponents.

- 18.** Choose each of the items from the drop-down list in turn.

The corresponding stored vertex selection appears on the object, including all new vertices created by the tessellation. Note that the software automatically creates a soft selection for any vertices that the tessellation created between the original selected and unselected vertices; that is, on the border of the selection.

You could get the same results by copying the stored channels back to the vsel channel in the Map Channel Info dialog, but Select By Channel makes it easier to access the various

stored selections. You can pass the selection in the active selection channel up the stack to further modifiers.

Normally, if you change an object's geometry type, it's possible to lose a sub-object selection. But with Channel Info, stored selections remain intact, as you'll see in the final part of this lesson.

- 19.** Right-click the octopus and convert it to an Editable Patch object. Reapply the Select By Channel modifier and access the different stored channels.

The channels are empty, because Channel Info doesn't support stored vertex selections in patch objects. But, as you'll see in a moment, the stored mesh-vertex selections are still available.

- 20.** Convert the octopus to an Editable Mesh object. Apply another Select By Channel modifier and access the different stored channels.

The vertex selections remain intact. If you performed the same series of conversions, starting with an editable mesh with a vertex selection, the selection would be permanently lost after the first conversion.

Tip: If you're doing this sort of work and find that you can't paste a copied channel that you think you should be able to, try clicking the Update button on the Map Channel Info dialog. This step is necessary, for example, after object type conversions and topology changes.

The next procedure follows on from this one. If you'd like to try it later, save this file first.

Apply texture blending with the Vertex Color map:

In 3ds Max, the Vertex Color map works in conjunction with Channel Info to provide access to the different named channels. This lesson shows how to use the capabilities of the Vertex Color map along with stored vertex selections to blend textures on an object's surface.

This lesson follows on from *the one above* (page 1–207). If you haven't done the previous procedure, please complete it before attempting this one.

You'll create a composite material and use opacity to specify which sub-material should appear where.

1. Continue from the previous procedure, or open the file you saved at the end, or open the included file *octopus01.max*.
2. Open the Material Editor and apply the first material (1-Default) to the octopus.
3. In the Material Editor, click the Standard button, and in the Material/Map browser, double-click Composite. When the Replace Material dialog appears, click OK to continue.
4. At the top of the Composite Basic Parameters rollout, click the Base Material button.
5. Click the Diffuse color swatch and set it to a bright green color.



6. Click the Go To Parent button, and then click the Mat. 1 button. Choose a Standard material for material 1.

The Composite material uses opacity to determine how the different materials overlay the base mesh, so that's where you apply a Vertex Color map. You'll use Vertex Color because it provides access to the named, stored channels.

7. On the Blinn Basic Parameters rollout, click the Opacity map button to the right of the spinner, and choose the Vertex Color map.

8. On the Vertex Parameters rollout, find the Channel Name field and click the arrow button to its right.

The drop-down list shows the vertex-selection channels you pasted and named.

9. Choose the Head Vertices channel.
10. Click the Go To Parent button, and set the Diffuse color to a bright red.
11. Apply a UVW Map modifier to the object.

This is just so the renderer doesn't complain about missing map coordinates when you render.

12. Render the Perspective viewport.

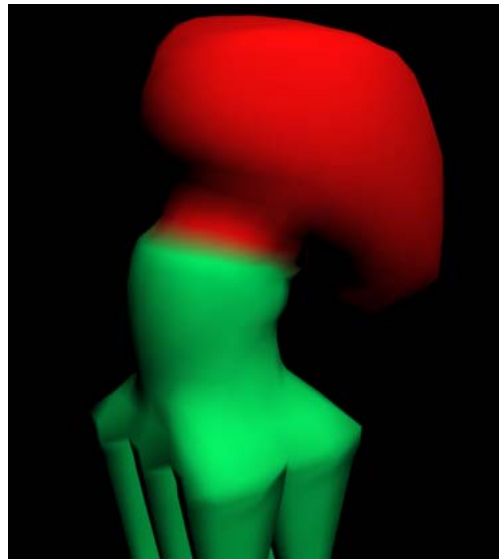

A slight amount of blending between the colored areas is the result of the soft-selected vertices created by the tessellation.

13. Click the Go To Parent button, and set Mat. 2 to a blue, Standard material, with Opacity mapped with a Vertex Color map set to the Leg Vertices channel.
14. Render again.

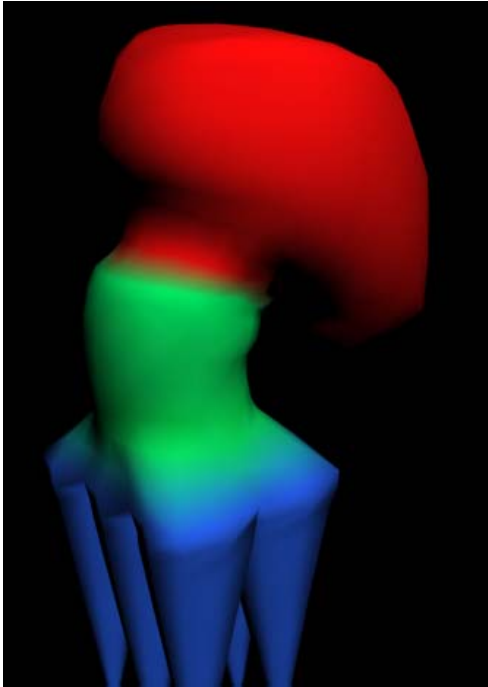

You now have an RGB octopus.

You can find the completed scene file in *octopus_final.max*.

15. Also try setting the different sub-materials to different maps such as Checker and Cellular.

This is a very powerful method of using any mapping channel to combine different materials on an object's surface.

Enable a morph object to survive a topology change:

Sometimes, after you set up a morphing animation with the Morpher modifier, you need to change the object geometry. For example, the client or technical director might request that you add a facial feature such as wart, which requires you to increase mesh resolution.

Normally, if you change the topology of the base morph object, the morphing animation is completely lost because the base object's topology

then differs from that of the targets. To recover, you must re-create the morph targets using the new topology, which can be a lot of work.

Instead, you can reuse the original morphing animation via the Channel Info's Copy and Paste functions, thus saving a great deal of time and effort.

1. Create a base object, convert it to Editable Mesh or Editable Poly, make several copies, and modify the copies to create morph targets. Use the Morpher modifier to set up a morphing animation on the base object.

You can use your own scene, or load the included scene file *octopus_morph.max*. The remainder of the lesson assumes you're using this scene, which contains a low-polygon octopus moving its head and legs using three morph targets.

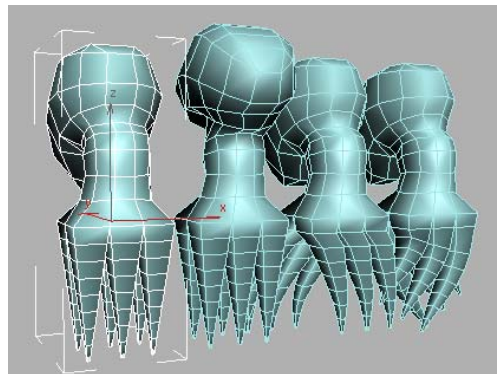

2. Play the animation.

The leftmost object, the one animated with the Morpher modifier, moves its head and legs. This is also referred to as the *base object*. The remaining objects are *morph targets*; the base object uses these poses for the different phases of its animation. All four objects have the same geometry; this is a requirement for morphing animation.

Before starting, you'll demonstrate how changing the object geometry loses the morphing animation.

3. Select the base object, *octopus base*, and, on the Modify panel > modifier stack, click Editable Poly to go to the Vertex sub-object level.

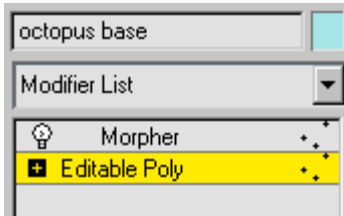

4. On the Edit Vertices rollout, click the Extrude button, and then, in the Perspective viewport, drag one of the neck vertices upward to extrude it outward.

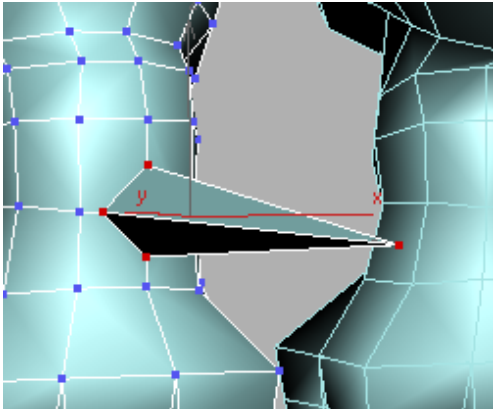

5. In the modifier stack, click Editable Poly again to exit the Vertex sub-object level.
6. Play the animation again.

The animation is lost. This happened because the base object's geometric structure, or *topology*, is now different from that of the morph targets.

7. Press **CTRL+Z** several times until the octopus is no longer selected, and then play the animation.

The morphing animation is restored.

To begin, you'll use Channel Info to copy each of the morph targets' mesh channels to different channels in the base object.

8. Select the base object, *octopus base*, and then open the Channel Info utility.
9. On the Map Channel Info dialog, click any channel, and then click the Add button three times to add three new map channels.

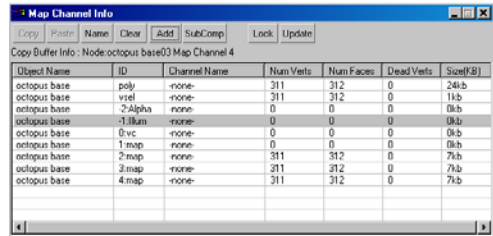

You can store the mesh data in existing channels such as Alpha, Illum, and vc, or add new channels to hold it. In this lesson, you'll do the latter.

10. Select the first morph target, *octopus head forward*. On the Map Channel Info dialog, right-click the first channel, *poly*, and choose Copy from the menu.

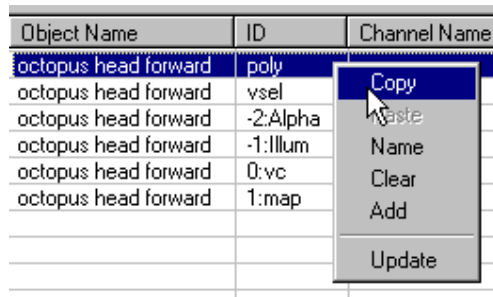

The poly channel contains the object's mesh data.

11. Select *octopus base* again and use the Map Channel Info dialog to paste to the 2:map channel, which is the first new channel you

created earlier with the Add button. Name the channel **octopus head forward**.

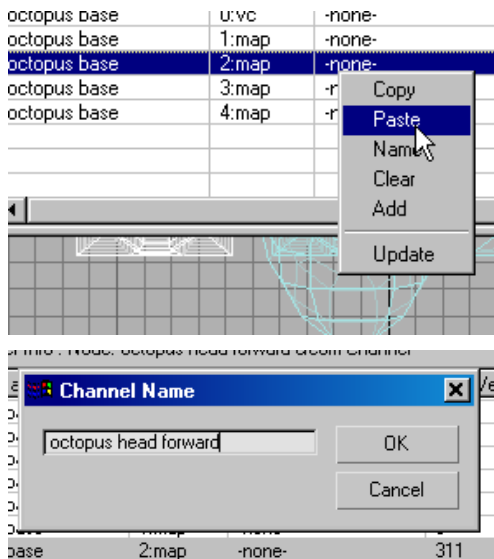

12. Similarly, copy the poly channels from the *octopus legs 1* and *octopus legs 2* objects (the second and third morph targets) to the *octopus base* object's 3:map and 4:map channels, respectively, naming the channels **octopus legs 1** and **octopus legs 2**, respectively.

octopus base	0:vc	-none-
octopus base	1:map	-none-
octopus base	2:map	octopus head forward
octopus base	3:map	octopus legs 1
octopus base	4:map	octopus legs 2

Tip: If you select multiple objects, they all appear in the Map Channel Info dialog, so you can copy and paste channels without having to change your selection.

13. Select the base object and, in its modifier stack, move the Morpher modifier above any UVW Mapping Paste/Add modifiers (drag it to the top of the stack).

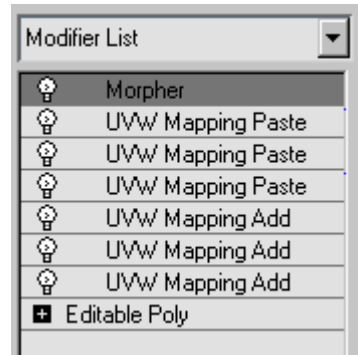

14. Right-click the uppermost UVW Mapping Paste modifier and from the context menu choose Collapse To.

The added/pasted channels are combined into the base object; only it and the Morpher modifier remain.

15. At the Editable Mesh/Poly level, refine the mesh. For example, you might use Slice, Cut, or Tessellate to add resolution. Try this: Select a few polygons on the front of the neck, click the QuickSlice button, click once on either side of the polygon selection, and exit the Polygon sub-object level.

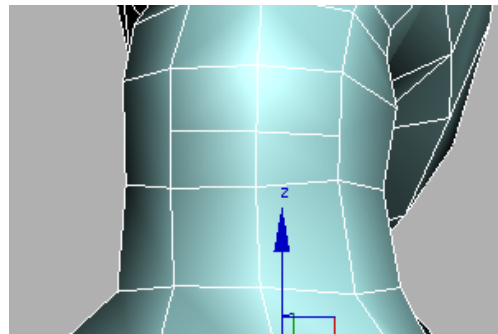

16. Play the animation.

Because of its modified topology, the base object no longer morphs into the target shapes.

17. Delete all the morph targets (not the base object).

18. Make three copies of the edited base object.

Each of these copies has the same topology as the modified base object, and contains all of the original morph targets' shapes in its mapping channels.

19. Select the first copy, open the Map Channel Info dialog if necessary, and copy the *octopus head forward* channel to the poly channel. It's not necessary to rename the poly channel when you paste.

The first morph target regains its head-forward pose.

20. Similarly, copy the *octopus legs 1* and *octopus legs 2* channels on the second and third copies, respectively, to the poly channels.

21. Optional: Recover extra memory used by the morph targets by deleting the mesh data stored in their mapping channels with the Clear function.

Lastly, you'll set the Morpher modifier to use the new targets.

22. Select the base object, go to the Modify panel, and click the Morpher modifier in the stack, if necessary.
23. On the Channel List rollout, right-click the first target name button (*octopus head forward*), choose Pick From Scene, and click the first morph target object in the viewport (*octopus base01*).

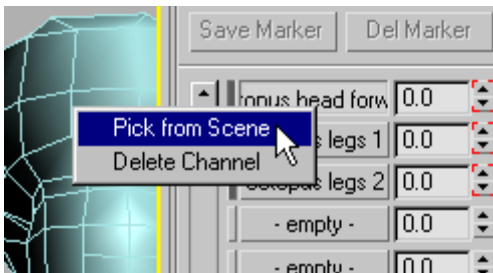

The new target name replaces the old one on the button.

24. Similarly, use the Channel List buttons to set *octopus base02* and *octopus base03* as the second and third morph targets.

25. Play the animation.

The morphing animation is restored intact with the modified topology.

You can find the end result of this lesson in the file *octopus_morph_final.max*.

Summary

With its ability to store different kinds of information in mapping channels for later retrieval, the Channel Info utility can play a role in helping you master a variety of tasks in 3ds Max. You can use it to:

- Eliminate unused mapping channels in an object, thus minimizing memory usage.
- Enable vertex sub-object selections to survive topology changes and object type changes.
- Blend texture edges on an object's surface, in conjunction with the Vertex Color map.
- Name map channels and sub-channels for access by the Select By Channel modifier.
- Restore morphing animation to an object after changing its topology.

Ink & Paint

Ink 'n Paint Material

The Ink 'n Paint material lets you create comics-style images without ever touching a pen or brush. This short lesson will show you a few of the options available with this versatile material.

Note: All the necessary files to do the tutorials can be found on the Tutorial Files CD that ships with

3ds Max 8. Before doing the tutorials, copy the *tutorials* directory from the CD to your *3dsmax8* local installation.

Set up the lesson:

1. Load the file *tut_inknpaint_spitfire.max*. This is located in the *tutorials\materials_and_rendering* folder.

This simple scene contains a World-War II airplane to which a standard material with a bitmap in the diffuse channel is applied.

2. Make sure the Perspective (lower-right) viewport is active, and then, from the Rendering menu, choose ActiveShade Floater.

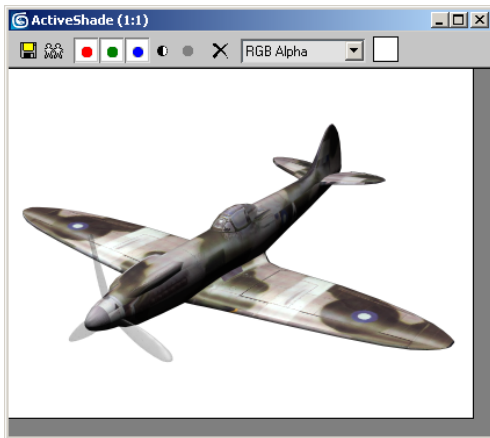

This opens a floating window that re-renders the scene whenever you change a parameter.

Note that the background color is set to white; this makes it easier to see the ink effects.

3. Click a viewport, and then press **M** to open the Material Editor. If necessary, reposition the editor dialog or the ActiveShade window so you can see both at the same time.

The first sample sphere shows the Standard material applied to the plane. You'll create an Ink 'n Paint material, and then apply it to the fighter plane.

4. In the Material Editor, click the second sample sphere to activate its slot, and then click the Standard button.

The Material/Map Browser window opens.

5. In the browser list, double-click the Ink 'n Paint item.

The browser closes, and the second slot now contains an Ink 'n Paint material.

6. Drag this material to the plane in the Perspective viewport or the ActiveShade window.

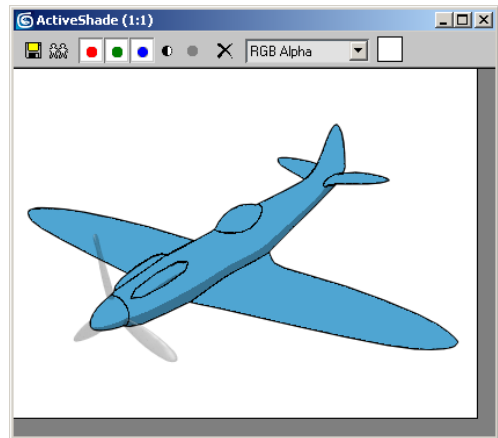

After a brief pause, the ActiveShade window re-renders the plane with the Ink 'n Paint material, giving it a much flatter look. Instead of black shadow, the bottom portion of the plane's fuselage is now colored with a darker shade of the blue paint color. Reapply the original material, observe the differences, and then apply the Ink 'n Paint material again.

With the default settings, the Ink 'n Paint look is a bit drab. You'll explore some of the alternatives, using first the paint controls and then the ink controls.

Modify the paint controls:

The Paint Controls rollout contains three basic settings: Lighted, Shaded, and Highlight. You'll look at each of these briefly, in turn.

1. The Lighted check box is on by default. Click it to turn it off.

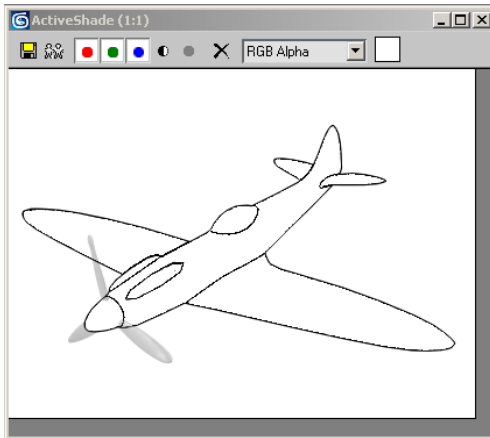

This removes all traces of paint from the object surface as rendered in the ActiveShade window, although the inked outlines remain. It doesn't affect the paint highlight, although that's not on right now so you cannot see it anyway.

2. Turn Lighted back on, and then, over on the right side of the rollout, click the upper half of the Paint Levels spinner once to set it to 3.

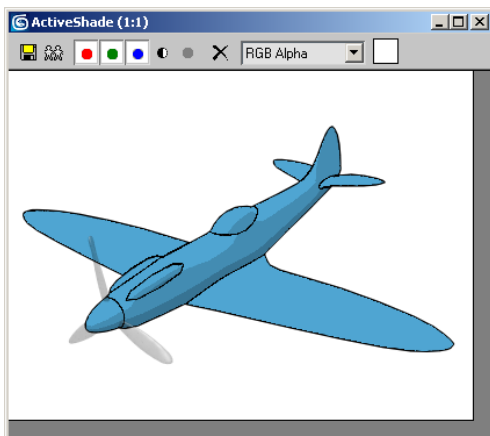

The plane now shows three levels of shading, with a new level between the two original levels.

By default, the Ink 'n Paint material uses two levels of shading to match the shading often found in color comics. However, you can increase this up to 255 for a more three-dimensional look, or to as low as 1 for a completely flat look.

3. Try increasing the number of levels a few more times, and then set it back to 3.

As you increase the number of levels, the area of pure paint color becomes smaller, while the darkest shaded area remains the same size.

Tip: To increase the size of the fully lit area, make the light source brighter by increasing its Multiplier setting. With this material, the light color has no effect, and changing the lighting intensity affects only the size ratio between lit and shaded areas.

Next, you'll look at the Shaded setting.

4. Currently, Shaded is turned on, and is set to 70. Change this to 35, and then 0.

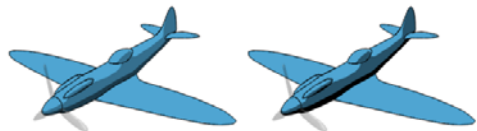

Left: Shaded=35; Right: Shaded=0

As you lower the Shaded value, the shaded areas of the surface get progressively darker, but the lit portion does not. Among other things, this lets you change the apparent lighting setup without touching the light source(s).

5. Turn off Shaded.

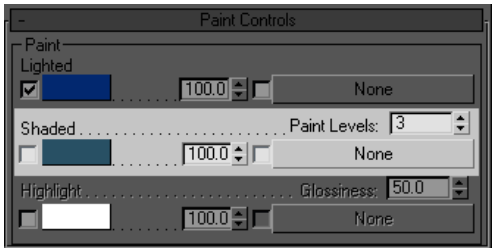

The spinner changes to a color swatch, currently showing a dark blue-green color. The shaded areas now blend between the Lighted color and the Shaded color.

- Click the color swatch and change the Shaded color to a markedly different one; say, a dark red.

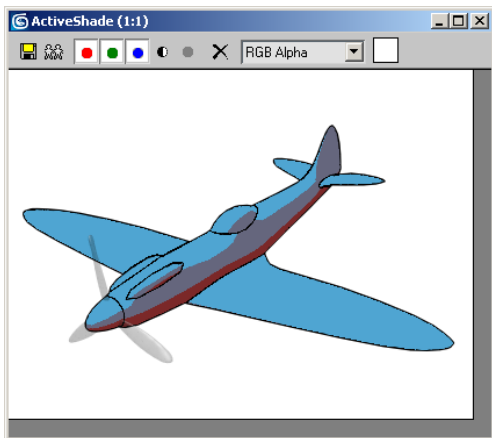

After a brief pause, the ActiveShade window displays the change.

- Try a few other colors, and also try increasing the Paint Levels setting for a smoother transition.

Next, you'll look at the Highlight setting.

- Turn on Highlight.

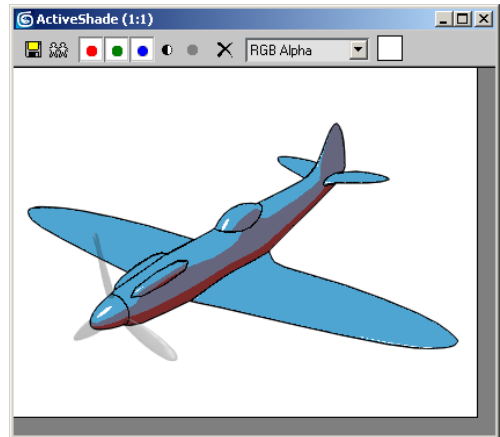

Bright, hard-edged highlights appear in the same places as the specular highlights in the original material.

- Set the Glossiness value to 20.

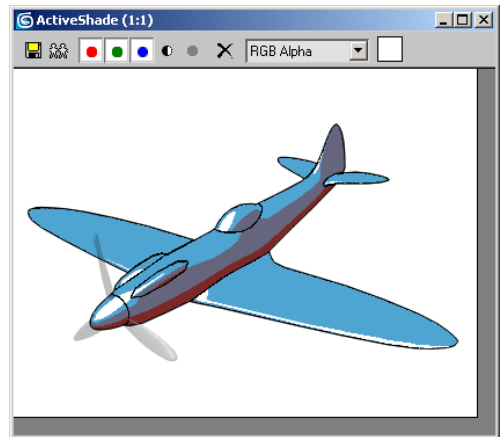

This works just like the Glossiness setting in the Blinn shader: Reducing it enlarges the highlight, while increasing it makes the highlight smaller.

Modify the ink controls:

- Create a new Ink 'n Paint material and apply it to the plane.

This lets you start over so you can isolate the ink settings.

2. Close the Paint Controls rollout so the Ink Controls rollout is completely visible.
3. First, turn off Ink.

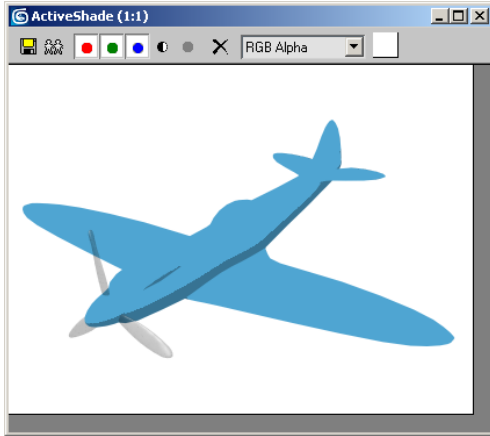

Now only the painted surface is visible. As you can see, the ink effect is very important for the comics look. In most cases, you'll want to keep Ink turned on when using this material.

4. Turn Ink back on, and then turn on Variable Width.
- A slight difference is visible. You'll increase the maximum width to make it more apparent.
5. Set Max to 10.

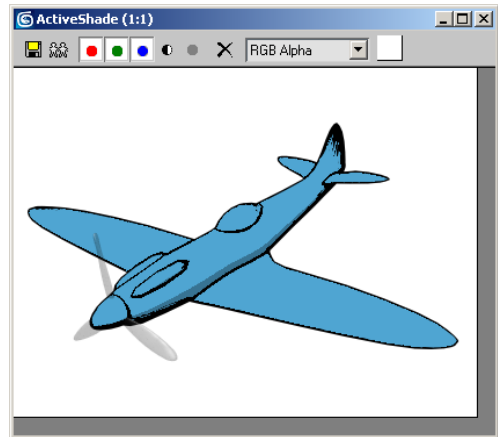

Now it's easier to see that the ink is thinnest where the light intensity is high, and thickest in the most deeply shaded areas. This replicates the look of drawn comics, where the artists ink the outlines of shadowed areas the thickest.

To conclude this lesson, you'll look at some of the available ink types.

6. Move down to the Outline setting, and turn off its check box.

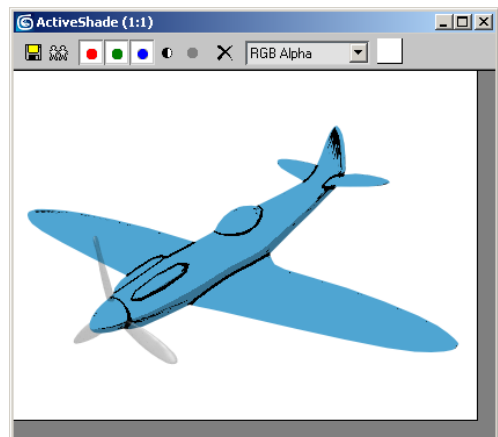

The outline vanishes, but the inner line of ink remains. The software creates outline ink only where the object's edges meet the background.

7. Turn Outline back on, and turn off SmGroup.

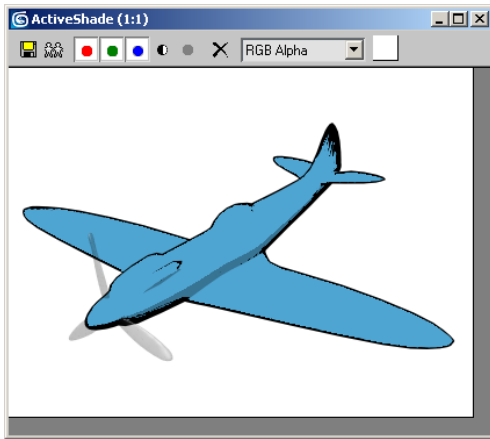

Now the lines acting like borders between faces assigned to different smoothing groups disappear.

8. Turn off Overlap.

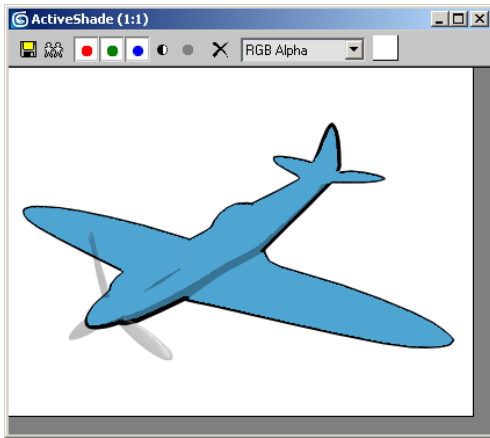

Now the inner line of ink is gone. Overlap ink is generated on the near surfaces when parts of an object's geometry overlap other parts.

9. Turn Overlap back on, and then turn on Underlap.

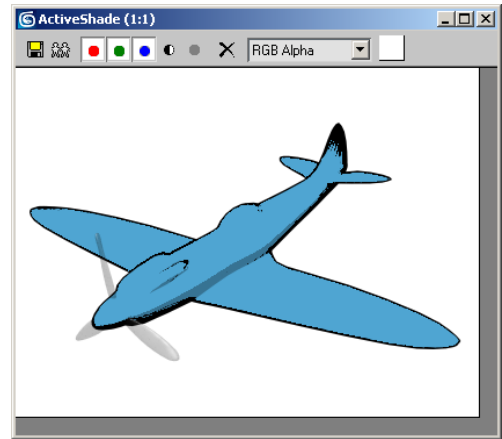

The inner line of ink appears to have thickened. Try toggling Underlap a few times. If you look closely, you'll see the thickness is added above the Overlap line. That's because Underlap ink is generated on the far surfaces adjacent to overlapping geometry (from the current viewpoint). Try turning off Overlap to see the difference.

Working with Maps

Lastly, you'll look at how you can use a map to give the rendering the look of a pencil/charcoal drawing.

1. Create a new Ink 'n Paint material and apply it to the plane.
2. Click the blue Lighted color swatch and set it to white.
3. Set the Paint Levels to 5.
4. Turn off Shaded in the Paint Controls rollout.
5. Click the map button in the Shaded channel (currently reads "None"), and then, in the Material/Map Browser, double-click Noise.
6. On the Coordinates rollout, set the X tiling to 25, the Y-Angle to -45 and the Z-Angle to 45.

7. On the Noise Parameters rollout, set Noise Type=Fractal, Size to **100**, High threshold to **0.6** and Low threshold to **0.4**.

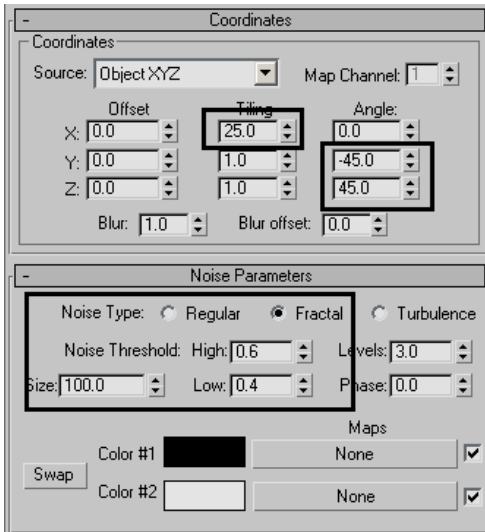

The paint now has a pencil stroke pattern applied to the shaded areas.

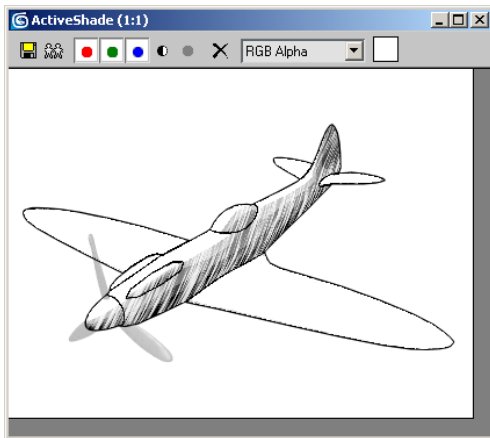

The effect can be strengthened by playing with the light sources in the scene.

8. Go to the Display panel and turn off Lights in the Hide by Category rollout.

9. Zoom out in the Front view and select the omni light above the plane.
10. Go to the Modify panel. In the Intensity/Color/Attenuation rollout, set the Multiplier value to **0.75**.

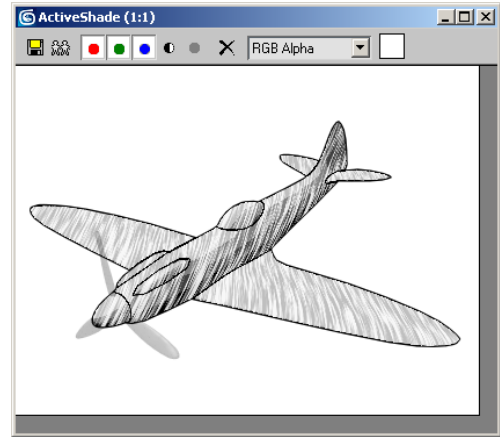

Summary

You've scratched the surface of the Ink 'n Paint material with this lesson, but there's much more to it than described here. For instance, you can use any 3ds Max map to specify almost any material component, and you can set each map's intensity to any percent between 0 and 100. You can use ink to outline smoothing groups as seen on the fighter plane in this exercise, but also on areas with different material IDs, and set different colors for each ink type. All of these settings let you achieve a wide range of effects with Ink 'n Paint.

Translucent Shading

Translucent Shading

The Translucent shader in 3ds Max lets you simulate substances that allow light but not clear

images to pass through. An example of this is the type of screen on which slides and movies are projected. In this short lesson, you'll use the Translucent shader to set up a projection screen where on its back surface you can see the image being projected as well as the shadow of an object between the projector and the screen.

Note: All the necessary files to do the tutorials can be found on the Tutorial Files CD that ships with 3ds Max 8. Before doing the tutorials, copy the *tutorials* directory from the CD to your *13dsmax8* local installation.

Load and render:

1. Load the file *tut_translucent_shader_start.max*. This is located in the *tutorials\materials_and_rendering* folder.
2. Activate the Camera02 viewport and render the scene.

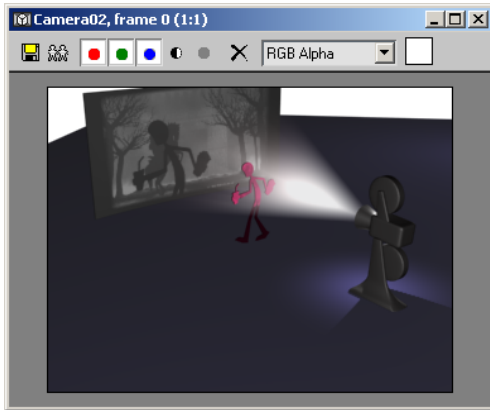

In the rendered image, you can see an image being projected onto a screen, with a cutout of a person walking in front of the projector casting a shadow onto the screen.

3. Activate the Camera01 viewport and render the scene again.

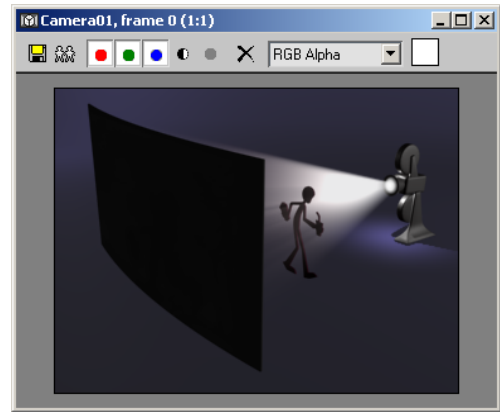

From this perspective, you can see the rear of the screen, but no image or shadow appear on it. You'll make the scene look more realistic by applying the translucent shader.

Change the shader:

1. In the Camera01 viewport, select the Screen object, and press the **M** key to open the Material Editor.
2. In the Material Editor, look at the fourth sample sphere, at the left end of the second row.

The material is selected. Its name is Screen, and you can tell that it's applied to the selected Screen object because of the solid white triangles in the corners.

Currently, the Screen material uses the Blinn shader, which is the default shader used by the Standard material.

3. On the Shader Basic Parameters rollout, click the drop-down list (where "Blinn" appears) and choose Translucent Shader.

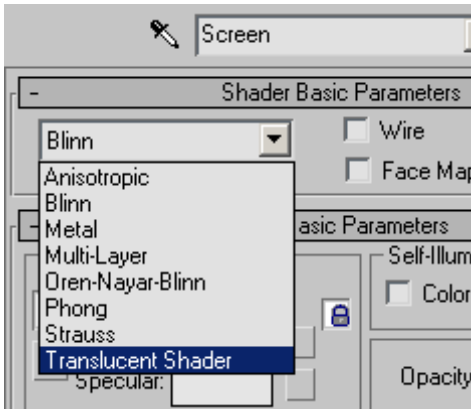

The name of the second rollout changes to Translucent Basic Parameters and a new Translucency group box appears at the bottom of the rollout.

You control the degree and color of translucency with the Translucent Clr (Color) setting. By default, this color is black, which effectively turns off translucency.

4. Click the Translucent Clr color swatch, and use the Color Selector dialog to set the Value to **174**.

By using a shade of gray, you change the translucency amount while maintaining a neutral tone for the translucent material.

5. Close the Color Selector dialog, and then render the Camera01 viewport again.

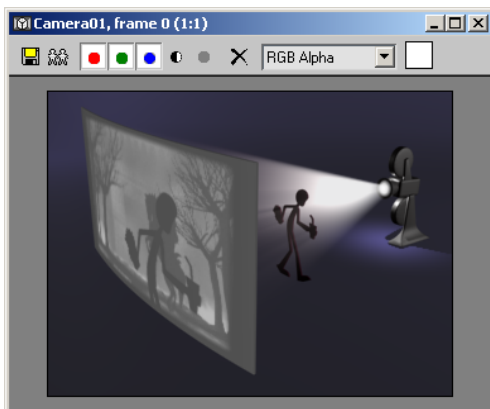

Now you can see the projected image and the shadow from the rear.

You can load this version of the scene from the file *tut_translucent_shader_finish.max*.

6. Try setting different colors and values for Translucent Clr, and render each time to see the difference. Also try setting different colors for the material's Diffuse and Translucent components, and rendering from the front and back.

The translucent color has no effect on the diffuse color, and vice-versa. For realistic results, use the same colors for both.

Summary

You learned how to work with the Translucent shader and use it to simulate the effect of an image shining through a projection screen. Other types of objects exhibit translucency as well, such as plastic and frosted glass. See if you can model such an object and give it a realistic look with the Translucent shader.

Animation

Animating with Auto Key

A bouncing ball is a common first project for new animators. This classic example is an excellent tool for explaining basic animation processes in 3ds Max.

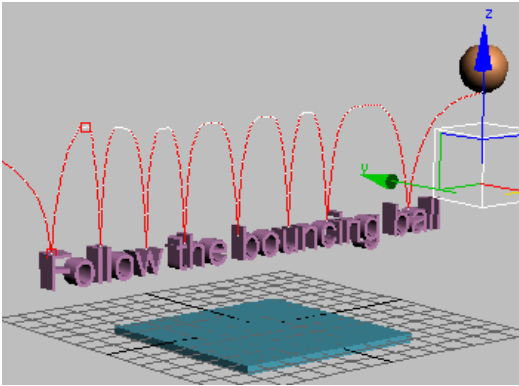

Skill Level: Beginner

Time to complete: 1 hour 45 minutes

Features Covered in This Tutorial

In these lessons you will learn:

- Creating animation using transforms.
- Copying keys in the track bar.
- Using ghosting to visualize in-betweens.
- Using tangent handles in the Function Curve Editor to control in-betweens.
- Creating looping animation using Parameter Out-of-Range Types.
- Animating using dummy objects.
- Using Layout mode.
- Applying Multiplier curves.
- Working with the Dope Sheet Editor to speed up animation and reverse time.
- Using Weighted List controllers.
- Creating squash and stretch effects with the Flex modifier.
- Animating using Set Key mode.

Tutorial Files

Files for this tutorial are found on the Tutorial Files CD in the `|tutorials|intro_to_animation` directory.

Before starting the tutorials, copy the `|tutorials` folder to your `|3dsmax8` directory.

Creating Animation Using Auto Key

In this lesson you'll start learning how to animate in 3ds Max.

Animate the ball using the Move transform:

1. Choose File > Open to open `bounce_start.max`.

The file can be found in the `|tutorials|intro_to_animation` directory.

Note: The following illustrations display the grid differently than you will see in your viewports. For ease of use, press **G** on the keyboard to hide the display of your grid.

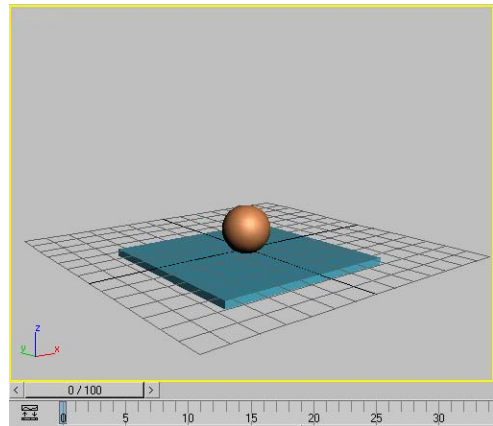

Perspective viewport: `bounce_start.max`

This file has the Perspective viewport on the left. This is not the standard viewport layout; the layout has been customized for this lesson.

2.  Click Auto Key to turn on this feature.

 The Auto Key button and the time slider background turn red to indicate that you are in animation mode. The viewport is

outlined in red, as well. Now, when you move, rotate, or scale an object, you create keyframes automatically.

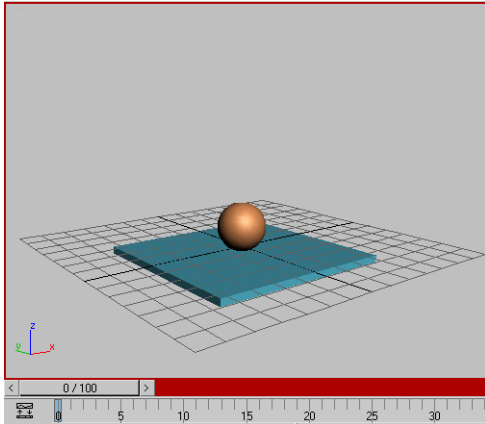

Time Slider background turns red

3.  Click to select the ball in the Perspective viewport. It is displayed within white selection brackets, indicating that it's selected.
4. Right-click the sphere and choose Move from the Transform quadrant of the quad menu.

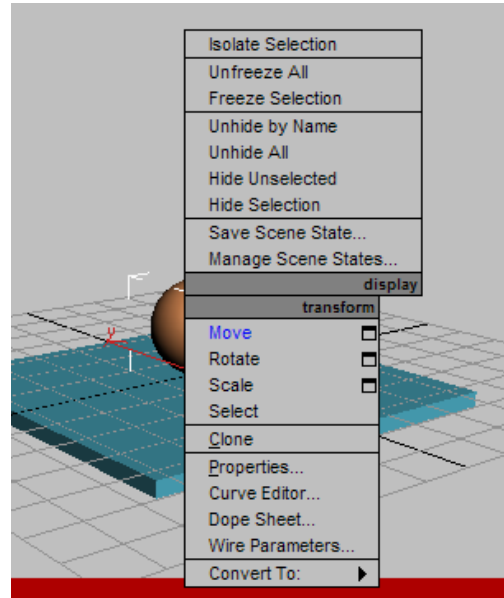

The Transform gizmo appears in the viewport. The Transform gizmo lets you easily perform constrained movements. As you move your cursor over the Transform gizmo, the different axes and their labels turn yellow.

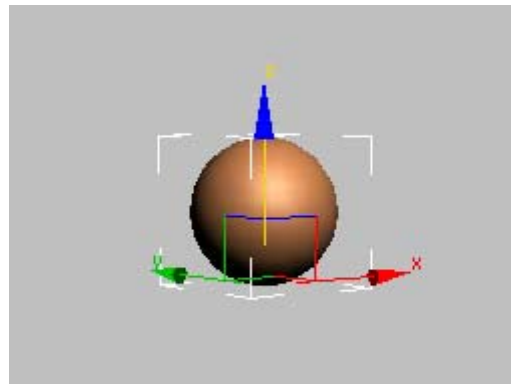

5. Position the mouse cursor over the Z axis, and when it turns yellow, click and drag upward to raise the ball in the air.

As you move the ball up in the air, notice the Z value changing in the Coordinate Display below the track bar.

The ball's position at frame 0 is now fixed above the box.

A Position key is created when you do this. The key is displayed on the track bar.

The track bar displays the keys for whatever is selected in the viewport. The track bar is found directly beneath the time slider and above the prompt area.

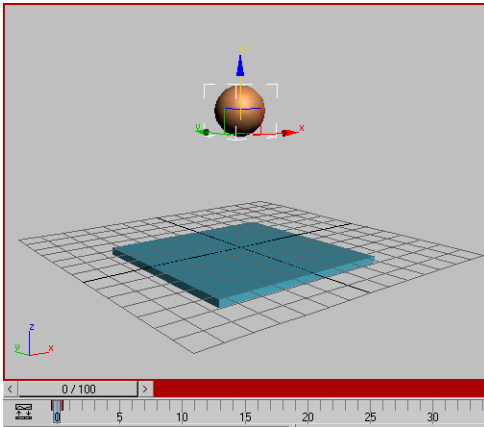

Keyframe created in Auto Key Mode

6. Move the time slider to frame 15.

To move the ball precisely down to the table surface, put your cursor in the Coordinate display Z field, and change the value to 0.

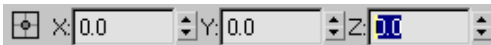

Coordinate Display type-in for precision animation.

The box is built off the world origin, so a Z position value of 0 will set the ball directly in contact with the box.

Note: The World Origin, (0,0,0) in XYZ coordinates, is shown by the intersection of the dark lines on the Home grid.

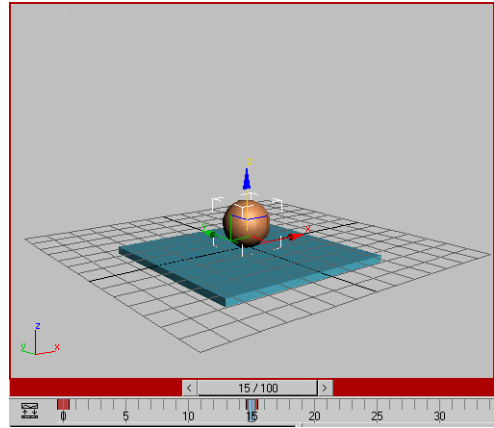

Frame 15: Ball is in contact with the box

You need to make the ball rise up to its original position at frame 30. Instead of moving to frame 30 and moving the ball up in the air, you'll use an alternate method.

Tip: You can zero the Z coordinate (or any other spinner) by right-clicking the spinner arrows.

- Put your mouse over the time slider's frame indicator (the grey box that currently reads 15/100 and right-click.

The Create Key dialog appears.

- In the Create Key dialog, change the Source to 0 and the Destination to 30, then click OK.

This copies the key from frame 0 to frame 30.

-  Click Play Animation to play the animation, or drag the time slider back and forth between frames 0 and 30.

The ball moves down and up between frames 0 and 30, and stays up in the air between frames 30 and 100.

-  If you clicked Play Animation, click Stop (the same button) to end the playback.

Next, you'll set the length of the active time segment to 30 frames.

11.  In the time controls, click Time Configuration.

12. In the Time Configuration dialog > Animation group, set End Time to **30**. *Don't* click the Re-Scale Time button. Click OK.

3ds Max lets you work in an active time segment that's a part of a larger animation. Here you are making frames 0 through 30 the active time segment. Notice that the time slider now shows only these frames. The other frames still exist, they just aren't part of the active segment at the moment.

13. Play the animation.

The ball goes up and down. Since the first and last frames are the same, the animation appears to cycle as it plays.

The ball moves, but it doesn't have "bounce" yet.

14. Stop the animation playback.

3ds Max made decisions on how the in-betweens are being distributed. Right now they are evenly distributed so the ball has no acceleration. It doesn't speed up or slow down; it just floats along with no sense of weight.

You need to simulate the effect of gravity so that the ball slows to a stop at the top of its bounce, speeds up as it approaches the table, and then bounces up again. To accomplish this, you'll use the key interpolation curves available on the Curve Editor. You'll also use the Ghosting feature to help visualize what the interpolation curves are doing.

Controlling In-Betweens

To make the ball bounce more convincingly, you'll change the interpolation on the key at frame 15.

You'll use the tangency handles available in the Curve Editor. The tangency of the curve will

determine the position in space of the in-between frames. Ghosting will let you see where the in-betweens are being positioned.

Using ghosting to visualize in-betweens:

1. Move the time slider to frame 15.
2. From the Views menu, click Show Ghosting to turn on this feature.

The ghosting feature shows object positions before the current keyframe in an aqua color.

3. Go to Customize menu > Preferences > Viewports tab, and set Ghosting Frames to **4** and set Display Nth frame to **3**. Click OK to exit the dialog.

The viewport displays the ghosting.

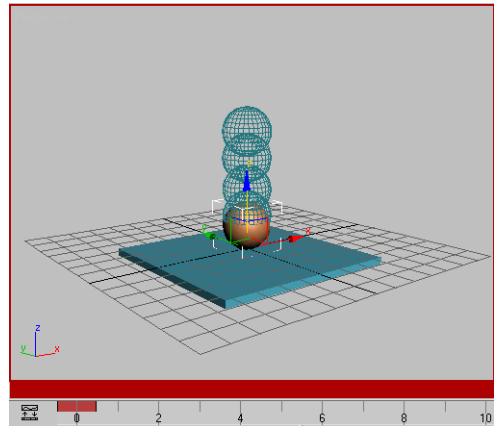

Ghosting shows the object positions on previous keyframes.

4. Play the animation, and then stop.
5. Now, to control the in-betweens, right-click the ball in the viewport and choose Curve Editor.

The Function Curve Editor is displayed across the top two viewports.

The Curve Editor is composed of two windows, a Controller window on the left that shows the names of tracks, and a Keys window on the right that shows keys and curves.

- In the Controller window on the left, click to select only the Z position track.

Note: If you don't see the Z Position track, click the plus icon to the left of the Sphere to expand the Sphere's tracks. If you don't see a plus icon, right-click and choose Manual Navigation, then hold down ALT and right-click, then choose Expand from the quad menu.

There are a lot of possible configurations in the Curve Editor, so you may encounter variations from the standard.

Now the only curve displayed in the Keys window is the one you want to work on.

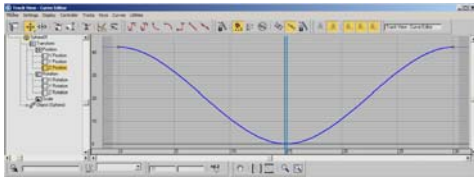

Function curve for bouncing ball Z position

- Move the Track View time slider (the double aqua line in the Key window).

As you move back and forth the animation plays in the viewport.

If you look carefully you'll see a dark dot on the curve at frame 15.

- Drag around the dark dot (the position key) to select it.

The selected key turns white on the curve.

To manipulate the curve you need to change the tangency type so you have access to tangency handles.



- On the Track View toolbar, click Set Tangents To Custom.

If you look carefully you'll see a pair of black tangency handles have appeared on the curve.

- Hold down the SHIFT key and drag the left handle on the left upwards in the Key window. The SHIFT key allows you to manipulate the left handle independently from the right.

The curve now looks like this:

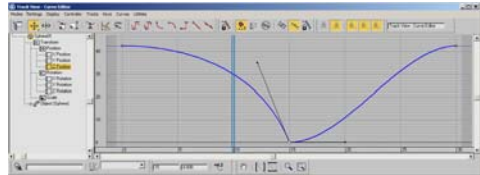

SHIFT key allows for manipulation of individual handles.

You'll change one more setting to make this tool more useful.

Using Interactive Update:

- On the Track View Settings menu turn on Interactive Update. Now move the time slider to frame 15, then manipulate the tangency handle while observing the effect in the ghosting. You can clearly see the changes as you work.
- Set the tangency handle so the in-betweens are mostly drawn toward the raised position (see the illustration that follows). With interactive update on you can do this with very fine control.

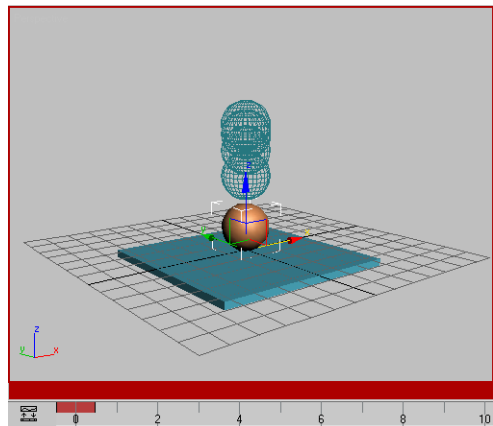

Interactive update and ghosting

3. Move the time slider to frame 30, then adjust the right tangency handle so it approximately matches the left one.

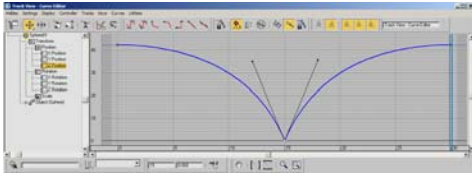

By manipulating this handle you can get different effects. The upward movement of the ball as it bounces off the table will determine the perception of the weight of the ball. The ball will appear to be bouncy, like a tennis ball, if the two handles are similar. The ball will appear to hang in space if enough of the in-betweens are drawn close to the topmost position.

4.  Turn off Views > Show Ghosting and then play the animation. Concentrate on the movement of the ball. Adjust the curve handles some more while the animation plays. Observe the effect.

The ball leaves the table as quickly as it hit it, then begins to slow down as it rises.

5. Play the animation, and then stop.

The ball has bounce now. It looks like there is gravity at work here.

When you see something you like in the viewport, it's a reminder that you should save your work. It's easy to forget while you're being creative.

6. Save your work as **mybounce.max**.

You've made the ball bounce once. In the next section you'll learn to repeat the bouncing of the ball using Out-of-Range types in Track View.

Adding Parameter Curve Out-of-Range Types

You can repeat a series of keys over and over in a variety of ways, without having to make copies of them and position them along the time line. In this lesson, you'll add Parameter Curve Out-Of-Range Types to the ball's position keys. Out-Of-Range Types let you choose how you want the animation to repeat beyond the range of the current keys. They have the advantage that when you make changes to the one set of keys, the changes are reflected throughout the animation.

Most of the tools in Track View are available both from menu choices and from toolbars. This feature is also on the Controllers menu.

Repeat keyframed motion:

1. Continue from the previous lesson, or open *bounce_repeat.max*. This is a 3ds Max scene with the ball bouncing once.
2. If the Curve Editor isn't displayed already, select the ball in the viewport, right-click, and choose Curve Editor from the quad menu.
3. In the Controller window, make sure that only the Z Position track is selected.

Before you repeat the keyframes, you'll extend the length of the animation.

4.  Click Time Configuration. This button is beneath the Go To End button in the animation playback controls at the bottom-right corner of the interface (not Track View).
5. Change the Animation End Time to **120**.

This adds 90 blank frames onto the existing 30 frames. It doesn't stretch the 30 frames over 120. The ball will still be bouncing once between frames 0 and 30.

6.  Now, back in Track View, click the Parameter Curve Out-Of-Range Types button on the toolbar.

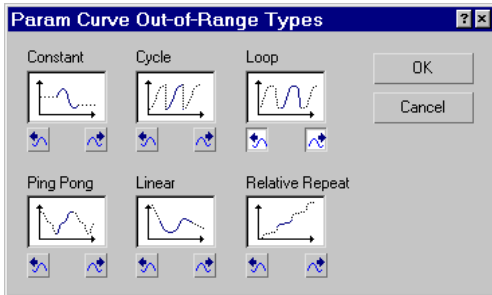

Parameter curve out-of-range type choices

7. Click both boxes under the Cycle graph to choose Cycle for In and Out. Click OK.

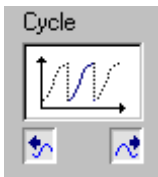

8.  Click Zoom Horizontal Extents on the Navigation: Track View toolbar at the lower right corner of the Track View window.

The Keys window zooms back so the entire time segment is visible. The Parameter Out-of-Range curves are displayed as dotted lines.

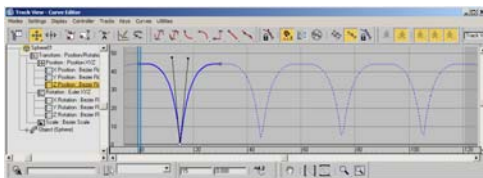

Parameter Out-of-Range curve

There are no keys beyond frame 30. Any change made to the original keys will be reflected in the looping.

Tip: You can create keys for the out-of-range curves by choosing Utilities > Track View Utilities > Create Out of Range Keys.

9. Play the animation.
The ball bounces over and over.
10. Save your work as **mybounce_repeat.max**

Next, you will learn to link the ball to a dummy object and then use the dummy to animate the position of the ball. This allows you to keep the bouncing independent from the position, and makes it easier to control the animation.

Animating with Dummy Objects

In this lesson, you will link the bouncing ball to a helper object. Then you can animate the helper so that the ball bounces across the top of some text. This animation technique is useful because you can control the ball's bouncing and its traveling motion independently.

Set up the lesson:

1. On the File menu choose Open.
2. Navigate to the `|tutorials|intro_to_animation` directory on your hard disk and open `bounce_dummy.max`.

This file is similar to the bouncing ball created in the last lesson. The only difference is that it has a text object prepared for you in the scene and it has a longer active time segment.

Tip: If you want to keep using your own bouncing ball, you can merge the text object in from the `bounce_dummy.max` file using File > Merge. Or create your own.

3.  If you didn't open `bounce_dummy.max`, you'll need to extend the active time segment to 240 frames. Click the Time Configuration button and then in the Animation group change End Time to **240**.

Create a dummy object:

1. Go to frame 0, if you're not there already.
2. Right-click the Top viewport to activate it, then zoom in on the ball and the box.



3. On the Create panel, click the helpers button, then on the Object Type rollout click Dummy.

4. In the Top viewport, move the cursor over the ball.

Tip: Move the Layers and Extras toolbars away from the Top viewport

5. Press the mouse button and drag outwards to create a dummy object.

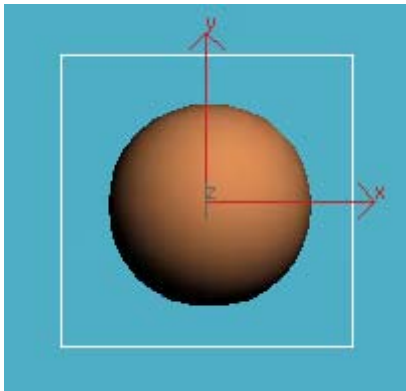

Make the dummy in the Top viewport.

If you look in the Front viewport, you'll see that while the ball is up in the air, the dummy is positioned at the same level as the box.

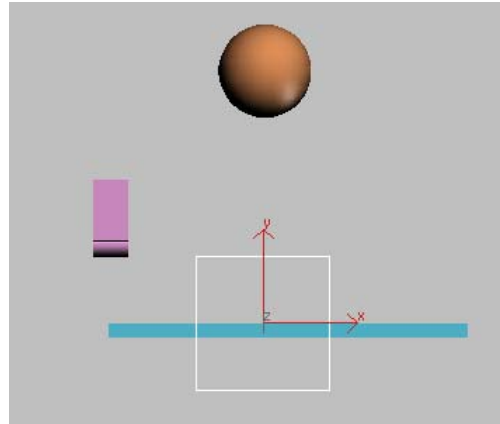

Dummy created below the ball

Next you will align the dummy so that it is centered over the sphere when viewed from the top.



6. On the toolbar, click Align. Then in the Top viewport, click the Sphere.

The Align Selection dialog is displayed.

7. On the Align Selection dialog, turn on X Position and Y Position, but leave Z turned off. Click OK.

You'll see the dummy shift position so it is aligned to the sphere.

Next, you'll align the dummy's pivot point with its base, and you will position the dummy so that it sits on top of the box. The idea is to set up the dummy so that its pivot point will match where the ball bounces. Then placing the dummy on any frame in time will ensure the correct alignment.



8. Select the dummy object, and go to the Hierarchy panel.

Instead of moving the pivot, you will move the object using Affect Object Only. This moves the object but leaves the pivot unmoved.

- On the Adjust Pivot rollout, click Affect Object Only to turn it on.

The pivot icon is displayed in the viewport.

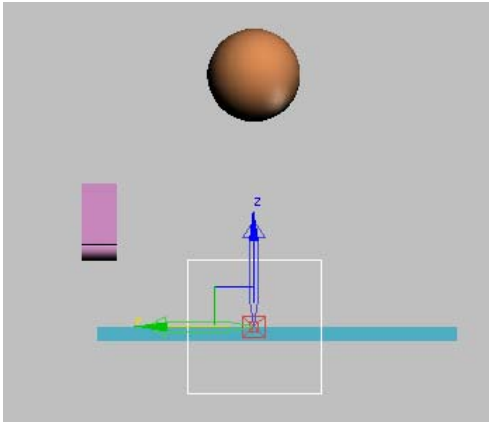

Pivot point tripod display

Now you can move the object to change its relationship with the pivot point.



- Turn on Select And Move, and raise the dummy cube so its base is level with the pivot tripod. Use the Transform gizmo so the dummy only moves up.

You don't want to move in any other axis, since the dummy is already centered properly in the other axes.

Tip: You can increase the size of the transform gizmo by pressing = repeatedly on the keyboard until the gizmo is the size you want.

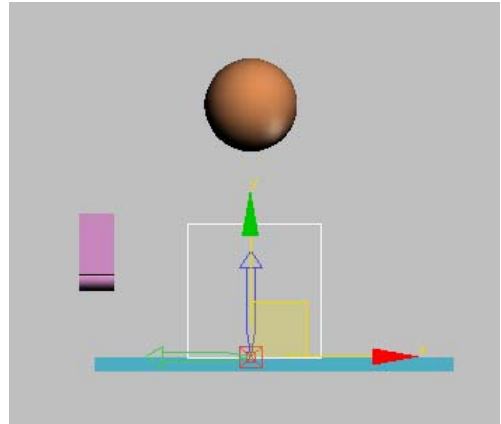

Equals key used to grow the transform gizmo

- Turn off Affect Object Only.

Now you will link the ball to the dummy. The dummy will become the parent to the bouncing ball.

Link the ball to the dummy:

- In the Front viewport, zoom in so you can see the dummy and the ball.



- On the main toolbar, turn on Select And Link.
- Move the cursor over the ball, then press and hold the mouse button. The cursor changes to two interlinked boxes.
- Move the mouse to the dummy. A rubber-band line follows the cursor. When the cursor passes over the dummy, it changes again. One box is white, showing you this object (the dummy) will be the parent of the first object (the ball). When the cursor has changed, release the mouse button.

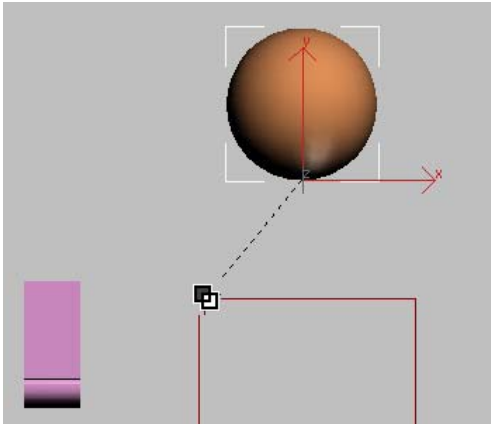

Link the ball to the dummy

You just linked the ball to the dummy.

You can also create linkages in Schematic View. For something this simple, it's easier to link directly in the viewport.

When you've created a linkage, it's a good idea to test it out to make sure you did what you think you did.

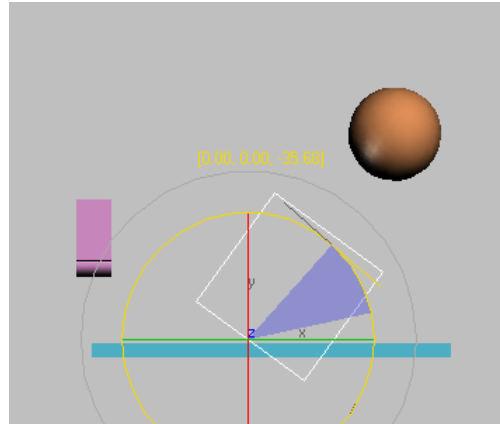

Testing the linkage

Now you're ready to animate the dummy. You'll use simple Auto Key animation first, just so you can understand the process.



Verify that you've created the hierarchy:

1.  On the toolbar, turn on Select Object.
2. Press **H** to select by object name.
3. On the Select Objects dialog, turn on Display Subtree, it isn't already on.

The Sphere01 object should appear indented below Dummy01 in the list.

4. Click Cancel to exit the Select Objects dialog.
5. You can also test a linkage by transforming the parent object. Rotating the dummy in the viewport will affect the ball as well. If you do this, then undo the transform once you've tested your linkage.

Animate the dummy:

1. Grab the divider lines between the viewports and drag them so the perspective viewport is wide screen.
2.  Turn on Auto Key
3.  On the main toolbar, turn on Select And Move.
4. At frame 0, move the dummy so it is to the left of the box in the Perspective viewport.

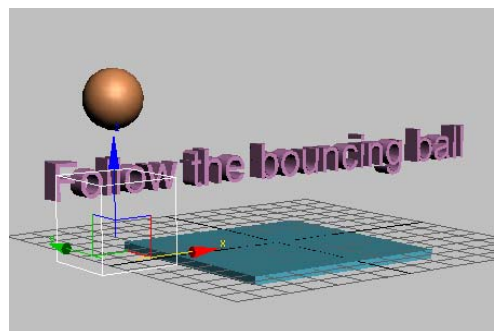

Dummy at frame 0

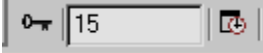
5.  Use the time slider to move to frame 15, or type 15 in the Go To Frame field.
6. Move the dummy using the Transform gizmo so the ball is touching the box.

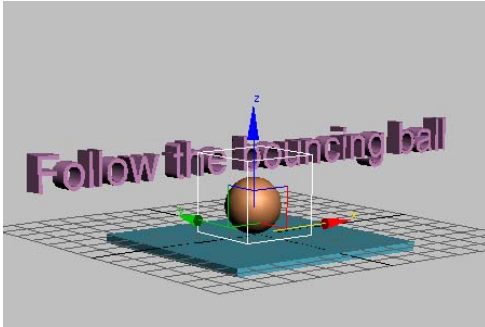

Dummy at frame 15

You just set two keys for the dummy, one at the start location at frame 0 and a second at frame 15.

7. Go to frame 30 and move the dummy again to the right of the box, so the ball continues to bounce away, rather than straight up in the air.

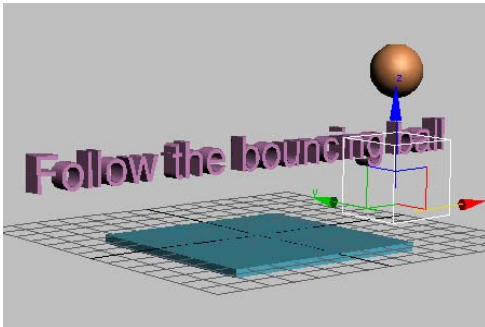

Dummy at frame 30

You've now set a third key at frame 30. If you play the animation, you'll see the ball bounce off the box as if it had been tossed.

You can display the trajectory of the ball to help visualize the animation. Here's how.

8.  On the main toolbar, turn on Select Object.

You can use any transform tool for this, but using Select Object ensures you don't accidentally transform the object.

9. Select the ball, and then right-click it.
10. Choose Properties from the quad menu.
11. In the Object Properties dialog, in the Display Properties group, turn on Trajectory.

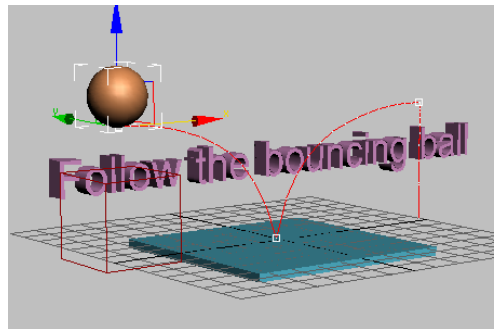

Trajectory display for the ball

12. Play the animation.

You see the ball bouncing onto the box and off, following the trajectory.

Try Layout mode:

If you turn off Auto Key and move the dummy, you will be moving the entire animation in space. When both Auto Key and Set Key are off, you are working in what is known as Layout mode. Here you will use Layout mode, so that instead of the ball bouncing on the block, the ball bounces off the letter F.

1.  Turn off Auto Key Mode.

The red disappears in the time slider background and viewport outline.

2. Move the dummy object back toward the text.

3. Watch the position of the trajectory and move the dummy until the bounce point of the trajectory intersects the top of the letter F.

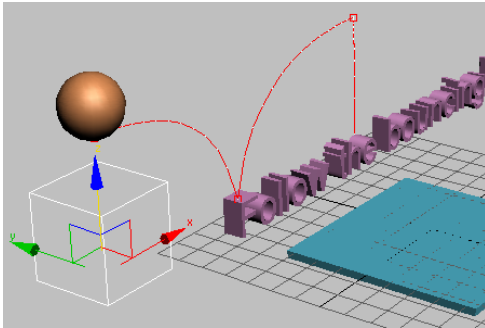

Layout Mode lets you move the animation in space.

Bounce the ball on the letters:

Now you'll repeat what you've learned to create the ball bouncing on the letters.

The ball bounces 8 times, making contact with the letters at frames 15, 45, 75, 105, 135, 165, 195, and 220.

1.  Turn on Auto Key.
2. In the track bar, select the key at frame 30 and delete it.
3. Move the time slider to frame 45 (or enter **45** in the Current Frame field).
4. Position the dummy so the ball bounces on the double L's in the word "Follow".
5. Move the time slider, then the dummy so the ball bounces on the following letters at these frames.
 - **F** at frame 15
 - **ll** at frame 45
 - **w** at frame 75
 - **th** at frame 105
 - **b** at frame 135
 - **u** at frame 165
 - **c** at frame 195

- **ba** at frame 225

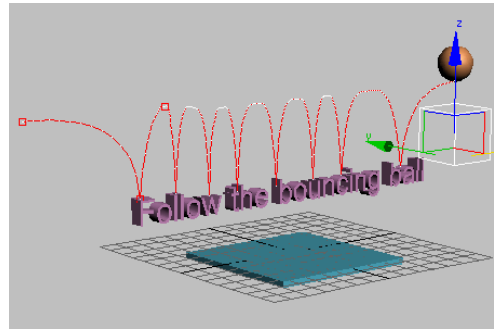

6. At frame 240, move the dummy so the ball move away from the letters.
7. Play the animation and observe the results.
8. Save your work as **mybounce_text.max**. If you had any trouble, you can open the file *bounce_text.max* to see the correct animation so far.

Next you will learn to use a multiplier curve to affect the height of the bouncing ball.

Add a multiplier curve:

1. Select the ball in the viewport, right-click and choose Curve Editor.
The Curve Editor window is displayed, if it wasn't already visible.
2. In the Controller window, click the Z Position track.
3. On the Curves menu, choose Apply Multiplier Curve. In the Controller window, click the plus icon. Click the Multiplier Curve to highlight it, then hold down the CTRL and click the Z Position track. This way you have only these two curves displayed.

In the Controller window, the Multiplier curve is added beneath the Z position track. It's not very noticeable in the Keys window on the right. The scaling of the multiplier track is quite small, so the slightest change to a key could result

in a large change in the animation. You can counteract this by zooming in on the multiplier track.



4. On the Navigation: Track View toolbar (at the lower right of the Keys window), click the Zoom Region button. Drag a zoom region window around the key at frame 240 on the multiplier track.

5. On the Settings menu, turn on Interactive Update.



6. On the Track View toolbar click Move Keys to turn it on, then move the multiplier key downward, while observing the effect on the trajectory in the Perspective viewport.

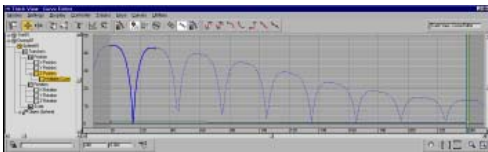

Lowering the multiplier curve shows effect on Z position curve in Keys window

Don't move it below the horizontal zero value, or you will get some strange effects.

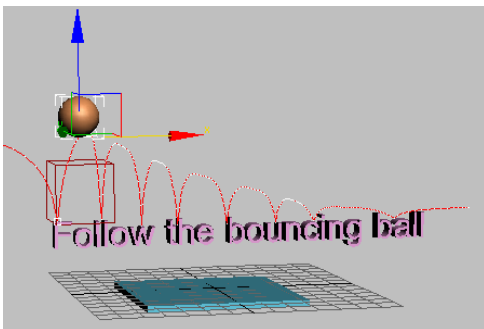

Multiplier curve shown on trajectory

Tip: You can type in precision values on the Key Stats: Track View toolbar.

While working with Multiplier curves, if you're not sure you like the results, you can just turn them off. Select the Multiplier curve in the Controller window, then on the Curves menu choose On/Off.



7. Click Zoom Horizontal Extents on in the Navigation toolbar to see the entire curve again.

Using the Dope Sheet Editor

Track View also has a mode called Dope Sheet, which lets you work with keys and ranges. In this lesson, you'll use the range function to make your animation go faster. You'll also use the Time tools to reverse your animation.

Speed up the animation:

The bouncing ball doesn't have enough pep. To speed up the animation, you'll use Edit Ranges in Dope Sheet mode.

1. Continue from before or open *bounce_multiplied.max*.
2. Select the dummy object in the viewport. Then, on the Graph Editors menu, choose Track View — Dope Sheet.



3. On the Keys: Dope Sheet toolbar, click Edit Ranges. By default, the Keys: Dope Sheet toolbar is on the top left.

The Keys window now displays the ranges for the animation.

4. In the Controller window, highlight the item label *Dummy01*. This way you will adjust the ranges of all the dummy's tracks at the same time.

Before making changes to the dummy, you want to make sure you also are making changes to the bouncing ball as well. Since the bouncing ball is the child of the dummy, you'll use the Modify Child Keys button.



5. On the Display: Dope Sheet toolbar, click Modify Child Keys to turn it on.

Now the changes you make to the dummy range will also be applied to the bouncing ball.

6. Click the end of the Dummy range and drag it to the left to around frame 100.



Range bars used to speed up the animation

This compresses the animation for the dummy and the bouncing ball so it happens within 100 frames.

Tip: You can raise the time ruler up from the bottom of the Keys window for greater precision.

7. Play the animation.

The animation plays faster. The ball continues bouncing at the end of the animation. There are several different ways you could correct this. You could try to use an ease curve to stop the animation, or create keys from the out-of-range curve, and then delete the keys. Or you can set the active time segment to 100 frames.



8. Click the Time Configuration button beneath the animation playback controls.
9. Change the Animation End time to 100.

Reverse time:

You can reverse the animation by using the Time tools available in Dope Sheet mode. It's easy to do.



1. On the Keys Dope Sheet toolbar, click Edit Keys.

The range bars are replaced with keys.

2. On the Time menu, choose Select.

When working with Time commands, you first select the time, then make changes to it.

3. In the Keys window, on the Dummy track, drag from frame 0 to frame 100 to select the time.

The time is displayed as a light yellow band in the Dummy track.

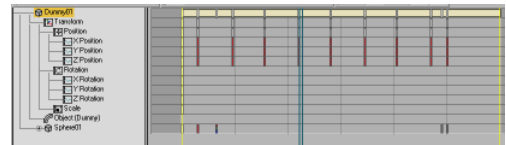

Time displayed as light yellow band

4. On the Time menu, choose Reverse

The animation plays backwards. The ball bounces from right to left instead of left to right, and the last bounce now happens on the letter F instead of the double L in ball.

Tip: You can easily reverse the playback of an animation using controls found in the Time Configuration menu. But if you need to actually reverse the keys, this is the technique to use.

Using Weighted List Controllers

There are many different animation controllers in 3ds Max. Each one has its own attributes, strengths, and uses. Each one has techniques associated with it. Controllers can be combined using weighted list controllers. By changing or animating the weights of controllers in a list, you can adjust each controller's effect, and animate in a nonlinear way. Here, you'll learn to animate the weights and to see what they can do.

Use the Weighted List controller:

With the Position List controller, you can add other controllers on top of the Bezier Position

controller you already have. Here you will add a Noise controller to layer the animation of a Ping-Pong ball.

1. Choose File > Open to load *pingpong_volley.max*.

A Ping-Pong ball and table are visible.

Tip: If the texture on the table looks wrong, right-click the Perspective viewport label and choose Texture Correction.

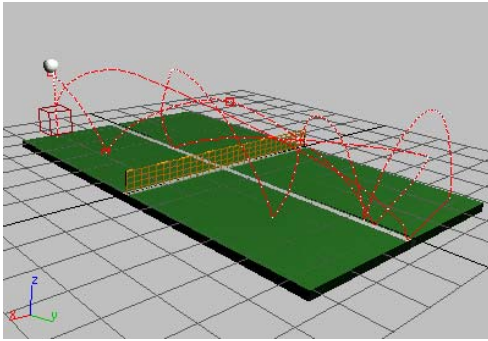

Ping-Pong volley

2. Play the animation.

The Ping-Pong ball bounces over the net in a simulated volley. The last four bounces happen in place. You can use weighted list controllers to remove those last four bounces, and replace them with a rolling motion. A Noise controller can be added to get rid of the bouncing, and instead you will have the ball wobble around on the table, then stop.
3. Select the Ping-Pong ball.
4. Open the Motion panel and expand the Assign Controller rollout.

Notice that the Assign Controller rollout displays the Position controller as a Bezier Position for the Ping-Pong ball. Use the pan hand in the window to read the label.

There are at least three different places where you can assign a controller to an object: in Track View windows, on the Motion panel,

or from the Animation menu. You'll use the Animation menu to assign the controller, and the Motion panel to edit the weights.

5. On the Animation menu (not on the Motion panel), choose Position Controllers > Noise.

The viewport trajectory changes into a frenzied red spline. Don't worry, this is correct.

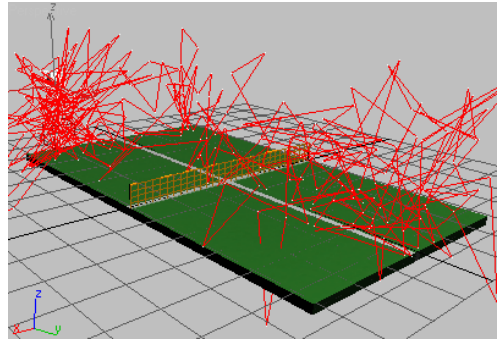

Noise controller: A frantic trajectory

Note: When you assign a controller from the Animation menu, a weighted list controller is automatically added to your object.

6. On the Motion panel, in the Assign Controllers rollout, expand the position list, and then the Noise Controller.

You can see that Noise Strength is indented beneath the Noise Position. If you scroll down a little, you can see that the Weight is listed as well.

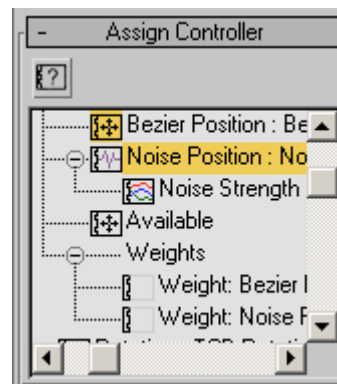

The new Noise Position track appears below the Bezier Position track. The old animation has not been replaced; instead, the new Noise controller has been added to it.

If you play the animation, the ball flies all over the place. It is following the position controller tracks. This probably isn't what you want here. You will need to adjust the noise parameters and the weighting of the controllers.

Adjust the Noise Frequency and Strength:

1. In the Assign Controllers window, highlight and then right-click the Noise Position entry and choose Properties.

The Noise Controller properties dialog is displayed

2. Change the Frequency to something very small, like **0.009**.
3. Change the Z Strength to **0.0**.

Important: If you miss this step, the tutorial won't work. The Z strength counteracts the up-and-down bouncing movement.

4. Change the X Strength and Y Strength to **1.0**.
This creates the motion of the ball wobbling around on the table surface.

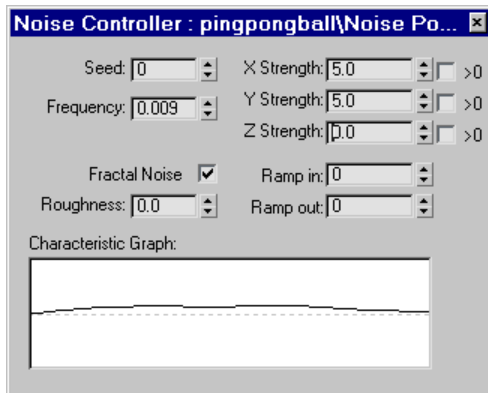

Noise Controller Properties dialog

5. Play the animation

The Noise is now less jittery, in fact barely visible. You need to weight the controllers so the noise doesn't affect the bouncing until frame 201, and to turn off the position controller after frame 200.

Animate the weights:

1. **Auto Key** Turn on Auto Key.
Auto Key The Auto Key button turns red.
2. Move to frame 200.
You'll set keys at frames 200 and 201 for the Bezier Position. You'll also set keys at frames 200, 201 and 0 for the Noise.
3. Open the Position List rollout, then in the window select the Bezier Position layer.
4. Locate the Weight field, then SHIFT+right-click the spinner arrows.

The spinner is outlined in red, showing a keyframe has been placed there.

Tip: You can set keys this way in both Set Key and Auto Key modes.

5. Select the Noise Position layer in the Position List rollout.
6. Right-click the spinner.
The Weight value is reset to 0, *and* a key is set.
Tip: Right-click any spinner to reset the value to 0 and set a key. SHIFT+right-click any spinner to add a key without changing the value.
7. Move to frame 201.

Tip: You can use the . key on the keyboard to move ahead one frame at a time. You can also click the arrows on either side of the frame indicator on the time slider.

8. With Noise still selected, enter **100** in the Weight field,

9. In the Position List, select the Bezier Position layer, then right-click the Weight spinner to set the value to **0** and set a key.

This removes the bouncing from this point on.

10.  In the animation playback controls, click Go To Start .
11. Select the Noise Position in the Position list, then set the Weight value to **0**.
12. Play the animation.

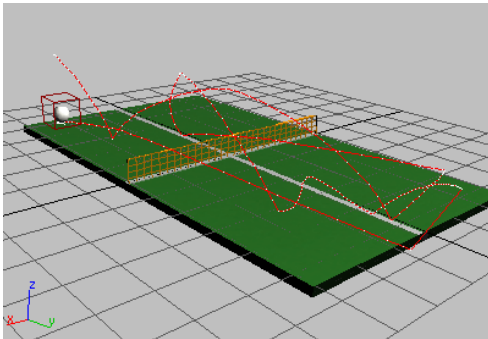

Ball stops bouncing after frame 200, rolls around table

The Ping-Pong ball bounces across the table, then stops bouncing, but still rolls around a bit.

13. If for some reason the ball is rolling around in the air, instead of on the table, go to frame 201 and move the dummy object down until the ball comes into contact with the table. Use this technique to correct any other errant movement.
14. To stop the ball's movement altogether, go to frame 250 and keyframe the Noise weight to **0**. Play the animation. The ball stops moving completely at frame 250.
15.  Turn off Auto Key.
16. Save your work as **mypongpong_layered_animation.max**.

You can open *pingpong_layered_animation.max* to compare your work with a completed tutorial file.

Adding Squash and Stretch with Modifiers

To create the illusion of cartoon movement, traditional animators rely on a technique called *squash and stretch*. For example, if a cartoon villain runs off a cliff, he will not descend to earth until he notices that he is suspended in the air. When he does descend, he will stretch on the way down, and then squash when he hits the desert floor.

In this topic, you'll add a little squash and stretch automatically to a Ping-Pong ball using the Flex modifier.

Note: You could also use XForm modifiers to manually achieve the same squash and stretch created in this lesson. You would use non-uniform scale transforms on the modifier gizmo to do this, rather than directly scaling the object, which can lead to unexpected results.

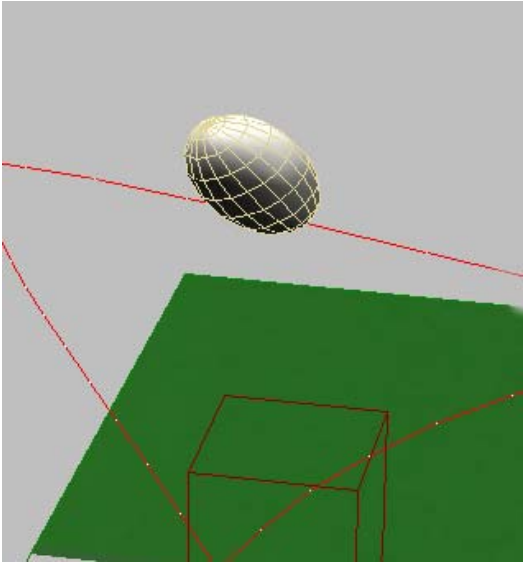

Flex modifier creating squash and stretch

Use the Flex modifier to generate squash and stretch:

1. Open *pingpong_layered_animation.max* and select the Ping-Pong ball.

Files for this tutorial are on the Tutorial Files CD in the *tutorials\intro_to_animation* directory.

2. On the Modify panel, open the Modifier List, and then locate and click the Flex modifier.
3. Play the animation in the viewport.
There's a little too much squash and stretch.
4. Reduce the Flex parameter to about **0.3** and play the animation again.

The ball is automatically stretched by the movement along the path. You can adjust a path value to improve this.

5. While the animation is playing, try entering different values in the Flex field. Also experiment with the Strength and Sway values. A good combination is a high strength (say **11**) and a low sway (around **1**). You can animate the Flex parameters to vary the effect.

Still another approach is to set all the keys yourself using a Stretch modifier to distort the ball. As mentioned earlier, you could squash the ball by putting an XForm modifier on it and then using Non-uniform Scale to reshape the gizmo. You could also squash the ball using free-form deformation (FFD) modifiers. Or you could use a Path Deform modifier. There are many possibilities.

Summary

In these Animation tutorials you have been introduced to the techniques of creating animation. You have learned to animate a bouncing ball using the Auto Key button and transforms. You have learned to control in-betweens using key interpolation and ghosting, and how to loop animation using Track View controls. You've learned about animating with dummy objects, using the Dope Sheet editor and weighted list controllers. Finally you've created squash and stretch effects using the flex modifier.

Flying a Spacefighter

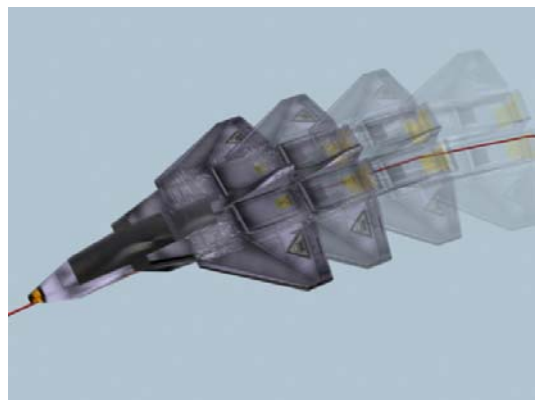

In this tutorial, you'll animate a spacefighter to make it fly along a simple path by using the path constraint. You'll also learn how to blend paths.

Skill Level: Beginner to Intermediate

Time to complete: 1 hour

Features Covered in This Tutorial

In this tutorial you will learn:

- Animating with Path constraints.
- Using dummy objects for animation.
- Using weighted list controllers to add turbulence.
- Setting keys using the Set Keys button.
- Controlling Euler controller rotations.
- Substituting high resolution objects for low resolution objects by using XRefs.

Tutorial Files

All the necessary files for this tutorial can be found on the Tutorial Files CD in the *tutorials\intro_to_animation* directory. Before starting the tutorials, copy the *tutorials* folder to your local *3dsmax8* installation.

Adding and Adjusting Flight Paths

In this first exercise, you'll assign a path constraint to the spacefighter and have it fly along a path. You'll also set a few path parameters to improve the flight dynamics of the spacefighter.

Set up the lesson:

- Load the *flyingspacefighter.max* file.
- Files for this lesson are in the *tutorials\intro_to_animation* folder.

This scene includes the following:

- A spaceship named *SpaceFighter*.

- A path, *Path01*.
- A (hidden) camera named *SpaceCam*.

Assign a path constraint:

1. In the Top viewport, select *SpaceFighter*.

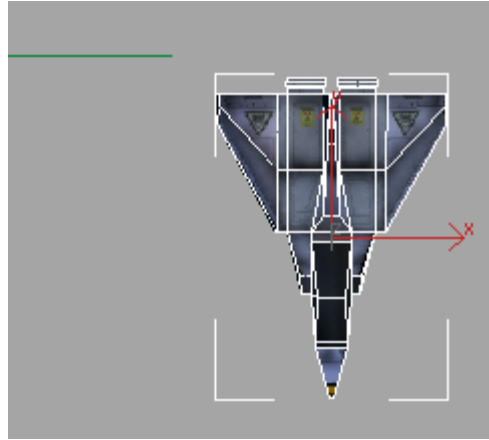

2. From the Animation menu, choose Constraints > Path Constraint.

You'll see a dotted line linking the spacefighter and your cursor.

3. Click the green line, *Path01*.

Once you pick the path, the spacefighter jumps to the start point of the path.

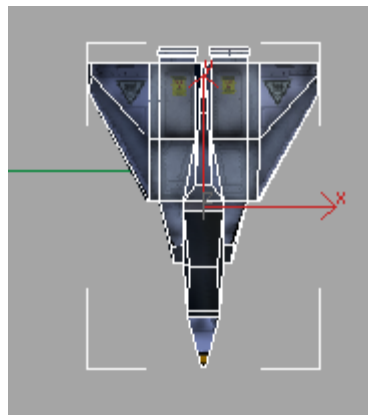

Note: The Motion panel is automatically opened on the command panel.

4.  From the Motion panel, slide the rollouts up until you can see all of the Path Parameters rollout, if necessary.

You'll see that *Path01* has been added to the path list.

5. Activate the SpaceCam viewport and play the animation.

The spacefighter moves along the path, but it's not facing the right direction and it slows down when it gets to the curves.

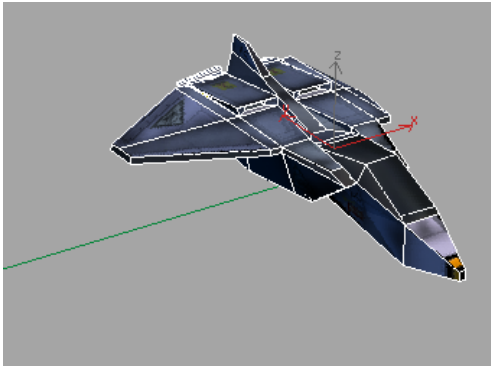

6. In the Path Options group of the Path Parameters rollout, set the following:

- Turn on Follow: the spacefighter follows the path and turns as the path curves, but it's perpendicular to the motion path.

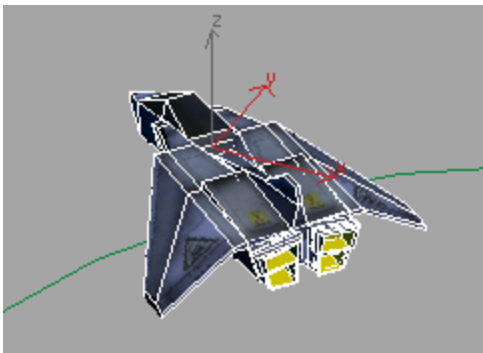

- In the Axis group, change the axis to Y: the spacefighter is reoriented and faces along the path, but it's flying backwards.

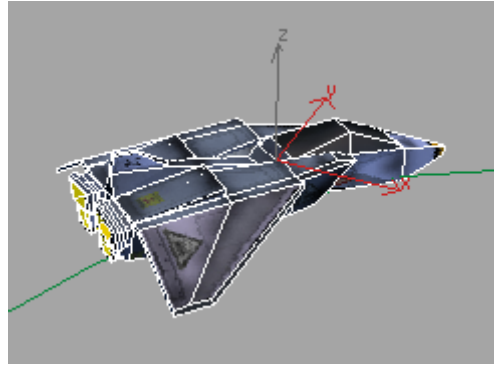

- Turn on Flip: the spacefighter now faces the direction it will move on the path.

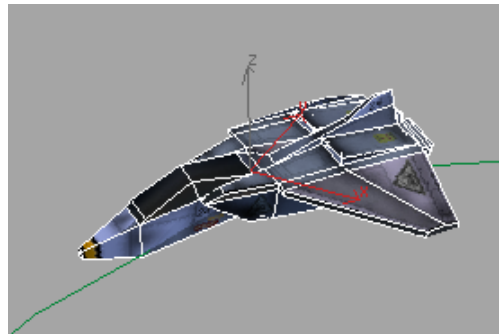

7. Play the animation again.

Now the spacefighter is moving along the path properly, but its flight dynamics don't look very realistic.

Improving the Flight Characteristics

In this section, you'll improve the flight characteristics of the spacefighter. You'll make it look more realistic when it enters and exits turns.

Make the flight more realistic:

1. Leave the SpaceCam viewport active and confirm that Constant Velocity is turned on in the Path Options group.

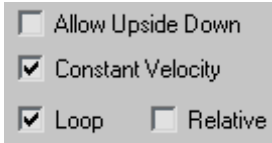

2. Play the animation.

Now the spacefighter doesn't slow down as it enters the curves. It has a fluid, continuous motion now, but still doesn't look very realistic.

3. Now turn on Bank and play the animation again, if it isn't still playing.

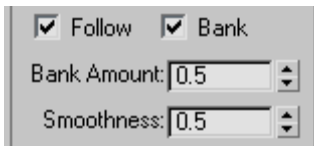

Now the spacefighter banks as it goes through the turns. It's subtle and needs to be made more pronounced.

4. Use the Bank Amount and Smoothness settings to make the spacefighter look like it's really banking into the curves of the path. Make the following settings:
 - Set Bank Amount to **7.0**.
Bank Amount controls how far an object rolls to either side of the path it travels along.

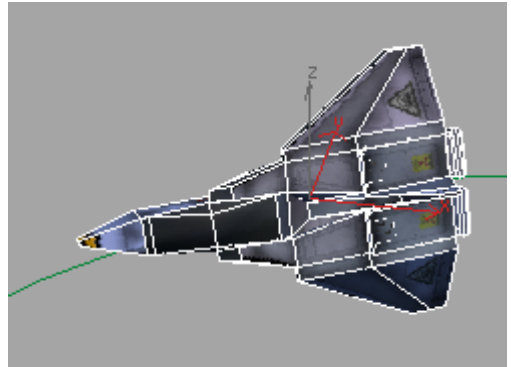

If you were sitting in the cockpit, positive values roll the starfighter to the left and negative values roll to the right. Be careful how high you set Bank Amount. If too high, the spacefighter will roll all the way over. Experiment with different settings and put it back to 7.0 before continuing.

- Set Smoothness to **1.0**.

Smoothness controls how rapidly the roll changes as the starfighter moves through bends in the path. Smaller values make the object more responsive to changes in the curve while larger values smooth out jerkiness.

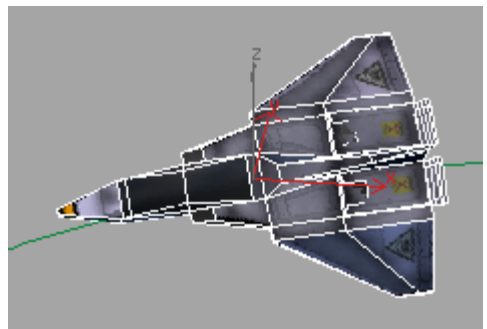

The spacefighter has a smoother look as it rights itself when coming out of the turns. Try increasing the Smoothness and see what happens.

Note: You can change settings while the animation is playing.

5. Save your scene as **MySpaceFighter01.max**.

Animating the Path of the Spacefighter

The parameters in the Path Parameters rollout can be animated. In this section, you'll make a few animated setting changes and see what happens to the spacefighter.

Animate path parameters:

1. Move the time slider to frame 60.
2.  Turn on Auto Key and set Bank Amount to **6.0**.

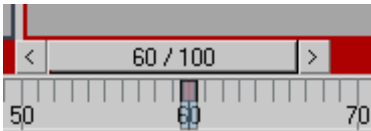

You'll see a new key added to the timeline at frame 60.

3. Slide the time slider to 75 and set Bank Amount to **12.0**.
4. Turn off Auto Key and play the animation.

As the spacefighter enters the second curve, it makes a drastic rolling turn, as if evading a missile or dodging a laser.

5. Save your scene as **MySpaceFighter02.max**.

Blending Paths

So far, you've worked with a single path. 3ds Max allows you to blend multiple paths, which can result in some interesting motion effects.

Set up the lesson:

- Open the file *flyingspacefighter02.max*.
Files for this lesson are in the *tutorials\intro_to_animation* folder.
This scene includes the following:

- A spaceship named *SpaceFighter*.
- Two paths, *Path01* (green) and *Path02* (red).
- A camera (hidden) named *SpaceCam*.

Fly the spacefighter along blended paths:

1.  Select *SpaceFighter* and open the Motion panel.

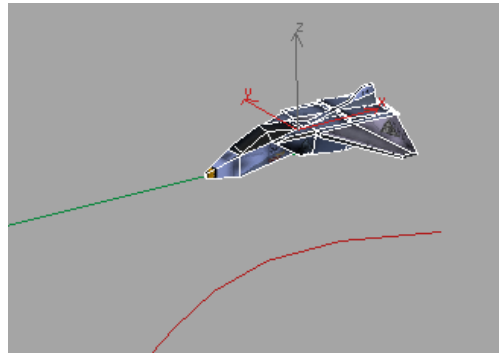

Spacefighter is already constrained to *Path01*.

2. In the Path Parameters rollout, click the Add Path button.
3. Select *Path02*, the red path.

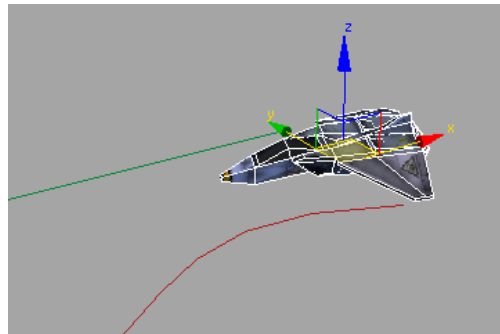

Notice how the spacefighter is positioned halfway between the two paths. This is because each path is influencing the spacefighter equally.

4. Click the Add Path button to turn it off.

5. Activate the SpaceCam viewport, if it's not already active, and play the animation.

The Weight setting controls how much the spacefighter is affected by each path.

6. Select *Path01* and set Weight to 25.
7. Play the animation again.

The spacefighter follows *Path02* more closely because it has a greater weight than *Path01*. Experiment with different Weight settings for each path and see what happens.

8. Save your scene as **MySpaceFighter03.max**.

Animating the Spacefighter with Constraints and Controllers

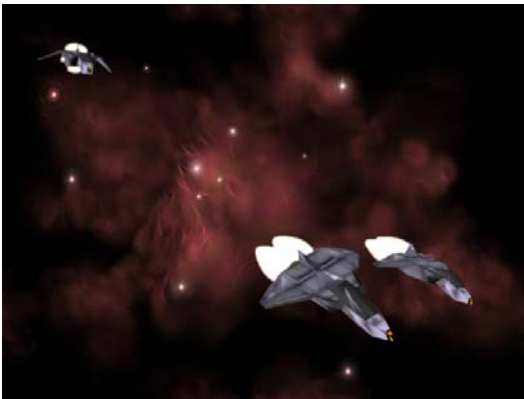

In this lesson, you'll use an assortment of constraints and controllers with a flight of spacefighter on a mission.

Set up the lesson:

- Open *flyingspacefighter03.max*.

Files for this lesson are in the *tutorials\intro_to_animation* folder.

The scene already contains the following:

- A flight of three spacefighters, *FlightLeader*, *Wingman01* and *Wingman02*.
- A dummy object, *SpaceshipControl*.

- Two motion paths, *flightpath (visible)* & *wingmanpath (hidden)*.
- A camera (hidden), *SpaceCam*.

Using a Dummy Object to Control the Flight

Dummy objects are very useful when setting up an animation. By animating a dummy, you can focus on getting your motion set up using a very simple object that doesn't slow down your system. Once the dummy animation is complete you link objects to the dummy. Now wherever the dummy moves, the object goes with it.

Link the spacefighters to the dummy:



1. Activate the Top viewport, if it's not already active, and click the Select And Link button from the Main toolbar.
2. Select *FlightLeader* and drag the cursor over the dummy, *SpaceshipControl*. Release the mouse button.

FlightLeader is now linked to the *SpaceshipControl*. Wherever you move *SpaceshipControl*, *FlightLeader* will follow.

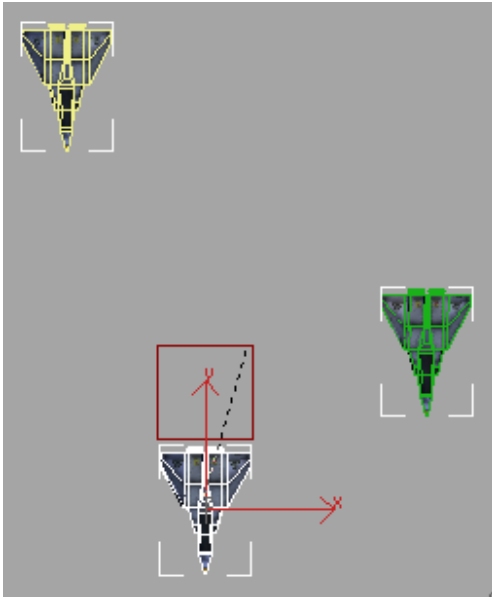

3. Link both *Wingman01* and *Wingman02* to *SpaceshipControl*.

Add a path constraint to the dummy:

1.  In the Top viewport, use Zoom Extents to view the scene.
2. Select *SpaceshipControl*.
3. From the Animation menu, choose Constraints > Path Constraint. Drag the cursor and click the *flightpath*.

SpaceshipControl jumps to the beginning of the path. The spacefighters follow along since they're linked to the dummy.

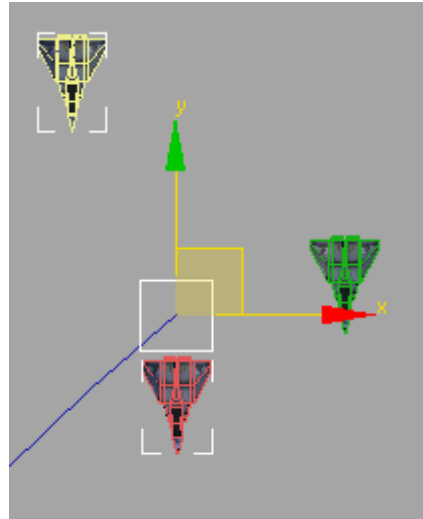



4. In the Path Parameters rollout, make the following settings.
 - Turn on Follow, Bank, and Constant Velocity.
 - In the Axis group, turn on Y and Flip.
 - Set the Bank Amount to **7.0** and the Smoothness to **1.0**.
5. Activate the SpaceCam viewport and play the animation.
All three spacefighters move along the flightpath.
6. Save the scene as **MyFlight01.max**.

Making the Camera Follow the Action

In this exercise, you'll use the Link Constraint to make the camera follow the flight as it passes by. Continue from the last lesson or load *flyingspacefighter04.max*

Add link constraint to the camera:

1.  Open the Display panel and turn off Cameras in the Hide By Category rollout.
The camera, *SpaceCam*, will appear.

2.  In the Top viewport, use Zoom Extents to view the scene. Select the camera target.

Also make sure the time slider is set to frame 0 (zero).

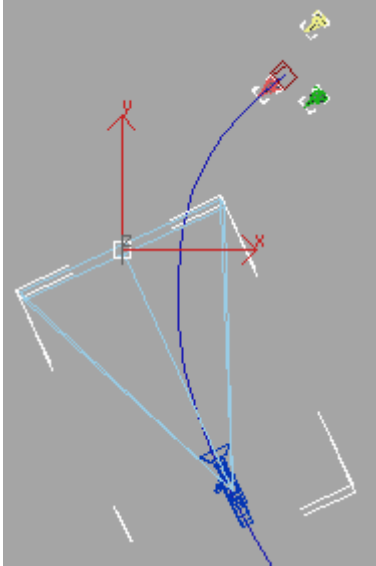

3. From the Main menu, choose Animation > Constraints > Link Constraint. Click the *flightpath* to set the first Link Parameter at frame 0 (zero).

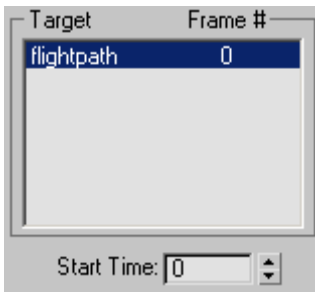

4. Move the time slider to frame 80 and click the Add Link button in the Link Params rollout. Click *SpaceshipControl*.

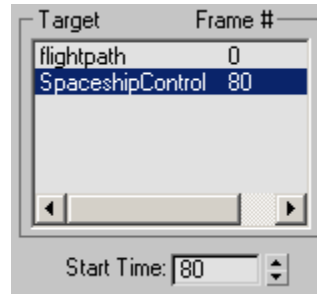

5. Click Add Link to turn it off.
6. Activate the SpaceCam viewport and play the animation.

The camera target is linked to the *flightpath* from frames 0 to 79. At frame 80, the camera target begins to specifically track the *SpaceshipControl* object.

7. Save the scene as **MyFlight02.max**.

Your Flight Leader Gets Cocky

Your flight leader has a pretty bold character. He or she feels a victory roll is in order as the flight passes by your vantage point from *SpaceCam*. In this exercise, you'll use the Orientation Constraint to control the rotation of the flight leader's spacefighter as it performs a barrel roll. Continue from the last lesson or load *flyingspacefighter05.max*.

1.  In the Top viewport, use Region Zoom to view the three spacefighters.

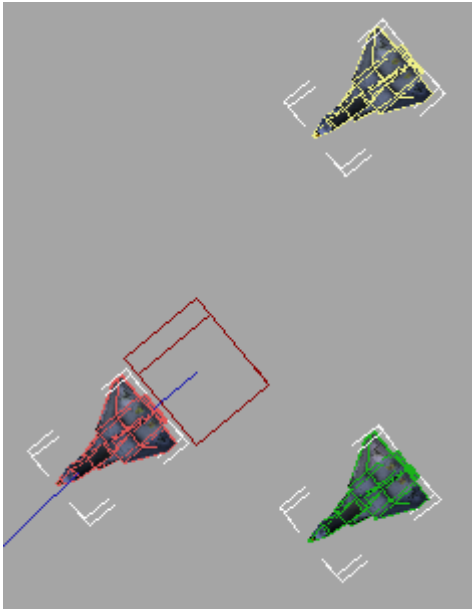

-  On the Create panel, click Helpers, then Dummy. Create a new dummy object near the *FlightLeader* and name it **barrelroll**.

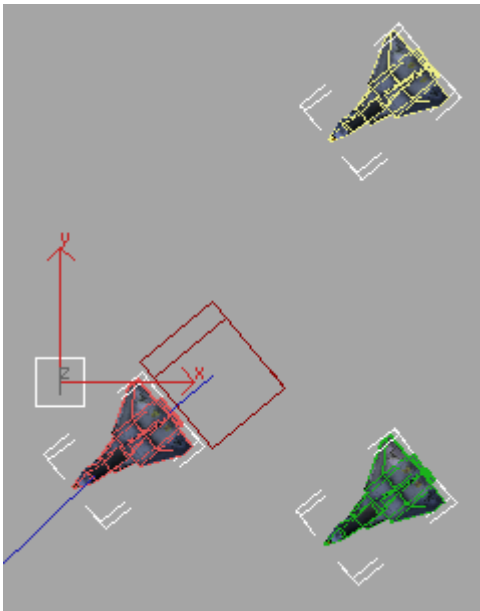

- Click Select And Link and link *barrelroll* to *SpaceshipControl*.
- From the Tools menu, choose Align, and click *SpaceshipControl*.

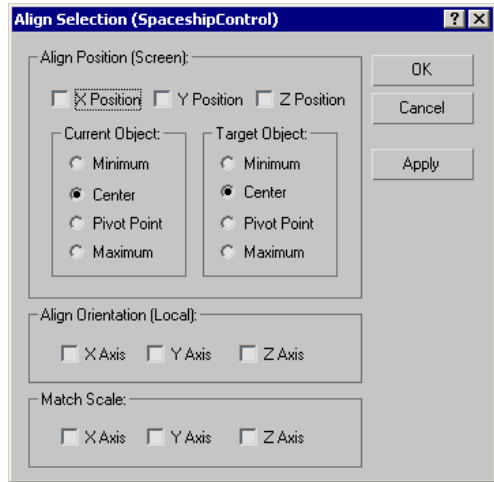

The Align Selection (SpaceshipControl) dialog appears.

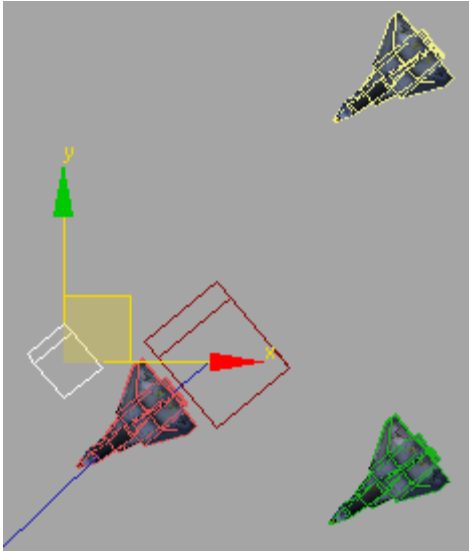

- In the Align Orientation (Local) group, turn on the X, Y, and Z axis controls and click OK.

The *barrelroll* dummy aligns to the *SpaceshipControl*.



6.  On the Motion panel, open the Assign Controller rollout, if it's not open, and select the Rotation: Euler XYZ controller.
7.  Click the Assign Controller button and choose TCB Rotation from the Assign Rotation Controller dialog.



Note: This will be very important later on, so don't miss this step.

Animate the victory roll:

1. Select the *FlightLeader* in the Top viewport.
2. Open the Animation menu and choose Constraints > Orientation Constraint. Move the cursor over the *barrelroll* dummy and select it.

You'll see *barrelroll* added to the Orientation Constraint Target list on the Motion panel.



3. Select *barrelroll* and make sure the time slider is at frame 0 (zero).
4.   Turn on the Set Key toggle and click the Set Key button.
5.  Move the time slider to frame 110 and click Set Key again.

You've added two keys that will keep the *FlightLeader* flying normally from frames 0 to 110.

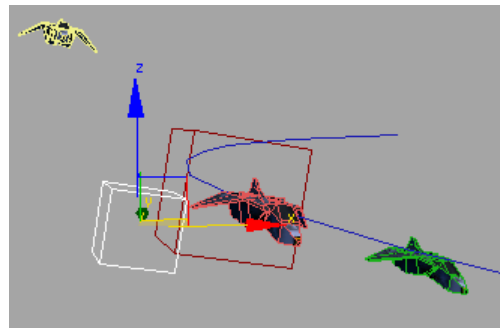

6. Activate the SpaceCam viewport and move the time slider to frame 130.
7.  Click Select And Rotate and change the Reference Coordinate System to Local.

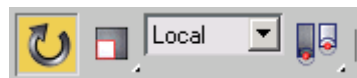

- Click the *barrelroll* dummy and rotate it around the Y-axis to about **180** degrees and click the Set Key button.

Note: If you'd like to be precise, you can enter the rotation in the Y-axis type-in field on the status bar.

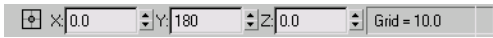

- Move the time slider to frame 150 and rotate the *barrelroll* dummy around the Y-axis another **180** degrees and click the Set Key button. Turn off the Set Key Toggle when you've finished.
- Save the scene as **MyFlight03.max** and play the animation.

A Wingman in Trouble

While the *FlightLeader* is performing stunts, *Wingman01* seems to be having some trouble. He doesn't seem to be flying as smoothly as the others. In this exercise, you'll use the Noise Controller to add some turbulence to *Wingman01* flight dynamics. Continue from the last lesson or load *flyingspacefighter06.max*.

Note: If you continue from the last lesson, make sure the time slider is back on frame 0 (zero).

Add turbulence:

-  In the Top viewport, use Region Zoom to view the three spacefighters, if you haven't done so already.

You might have to do a Zoom Extents first, then a Region Zoom to see the three fighters.

- Select *Wingman01*.
- On the Animation menu, choose Position Controllers > Noise.

Doing this automatically adds a List Controller to the *Wingman01*. The Position List contains the original Linear Position and the new Noise

Position controller with default Weight settings of 1.0.

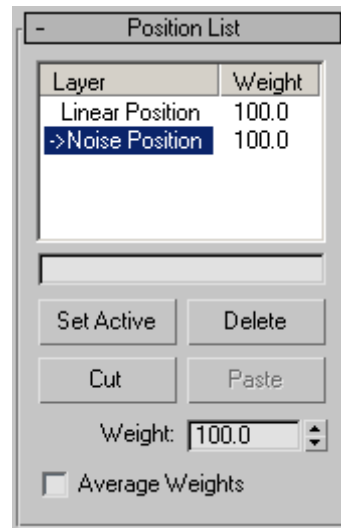

- Play the animation and note the erratic flying of *Wingman01*.
- Stop the playback and change the Weight of the Noise Position controller to **25**.
Now the flight path of the *Wingman01* spacefighter is affected by slight battle damage.
- Save the scene as **MyFlight04.max**.

A Wingman is Called Away

Now it looks like *Wingman02* has received a transmission and is being ordered to peel off and fly somewhere else. You'll revisit the Link Constraint to make *Wingman02* follow the *FlightLeader* for a little while then take off on another path. Continue from the last lesson, or load *flyingspacefighter07.max*.

Alter course for Wingman02:

- Reset your time slider to frame 0 (zero) and zoom to the trio of spacefighters in the Top viewport.

2. Create a new dummy near *Wingman02* and call it *WingmanControl*.

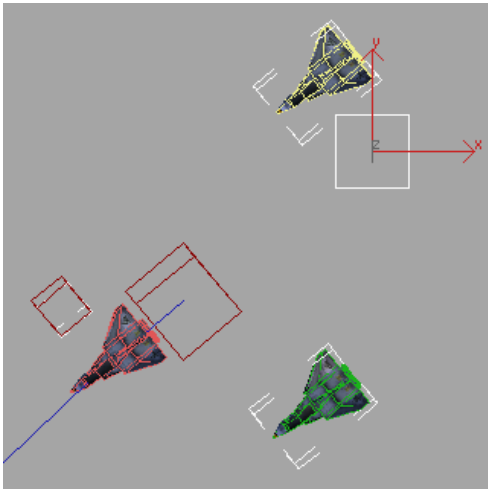

3. Right-click any viewport and choose Unhide By Name from the quad menu. Select *wingmanpath* and click Unhide.

A yellow path appears in front of *Wingman02*.
4. Make sure the new dummy, *WingmanControl*, is still selected and choose Constraints > Path Constraint from the Animation menu. Drag the cursor over and pick *wingmanpath*.

The *WingmanControl* jumps to the beginning of *wingmanpath*.

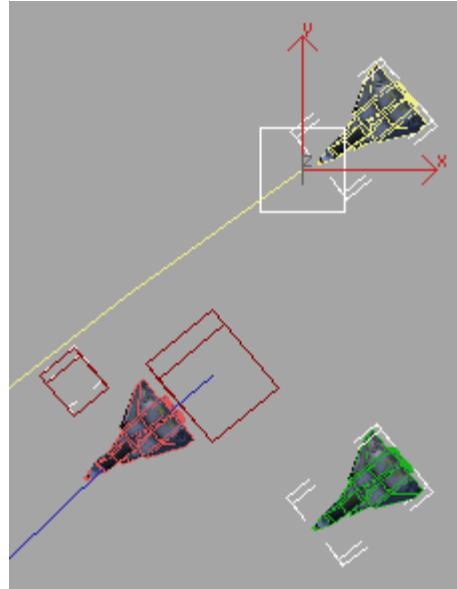

5. In the Path Parameters rollout duplicate the previous settings.
 - Turn on Follow, Bank, and Constant Velocity.
 - In the Axis group, turn on Y and Flip.
 - Set the Bank Amount to **7.0** and the Smoothness to **1.0**.

If you play the animation, you'll see *WingmanControl* on its own path.

Make Wingman02 change paths:

1.  In the Top viewport, select *Wingman02* and click the Select And Unlink button.

Wingman02 is no longer linked to the *SpaceshipControl* dummy object.
2. From the Animation menu, choose Constraint > Link Constraint and select *SpaceshipControl*.

Wingman02 will work as it did before, but the link constraint will give you the flexibility to have it follow a different path.

3. Move the time slider to frame 45 and click the Add Link button in the Link Params rollout on the Motion panel.
4. Click the *WingmanControl* dummy.
You will see *WingmanControl* is added to the Target list, and when *Wingman02* gets to frame 45, the spacefighter begins to follow the *WingmanControl* dummy on the other path.
5. Save the scene as **MyFlight05.max** and play the animation.

Make Wingman02 roll out of formation:

To make *Wingman02* roll out of formation, you'll use the Orientation Constraint again.

1. Move the time slider back to frame 0 (zero), if it's not there already.
2. Create another dummy object in the Top viewport near *Wingman02* and name it *wingmanroll*.

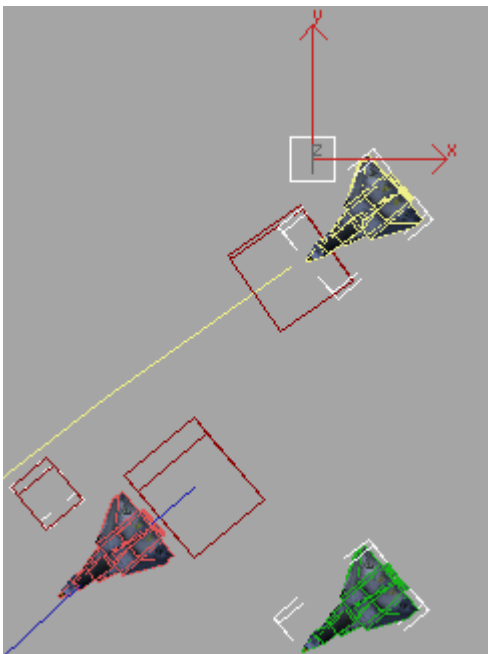

3. Use Select And Move to position *wingmanroll* next to *Wingman02*.

Watch the Front and Right viewports to help you position it. This will help you keep the objects in your scene organized.



4. Click Select And Link and link *wingmanroll* to *WingmanControl*.
5. From the Tools menu, choose Align, and click *WingmanControl*.

The Align Selection (*WingmanControl*) dialog appears.

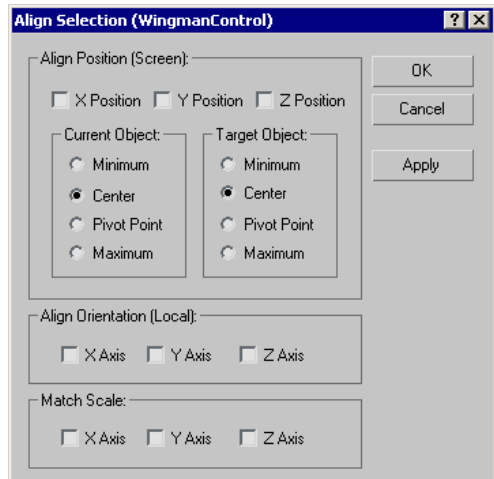

6. In the Align Orientation (Local) group, turn on the X, Y, and Z axis controls and click OK.

The *wingmanroll* dummy aligns to *WingmanControl*.

Note: This is important because you want to make sure that rotation values you give *wingmanroll*, later on, will be based on the initial orientation of *WingmanControl*. Otherwise, any rotation you give *wingmanroll* will result in the spaceship tumbling out of control.

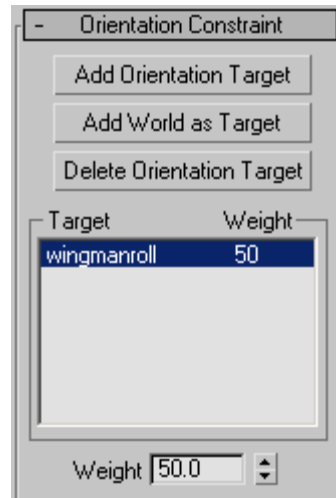
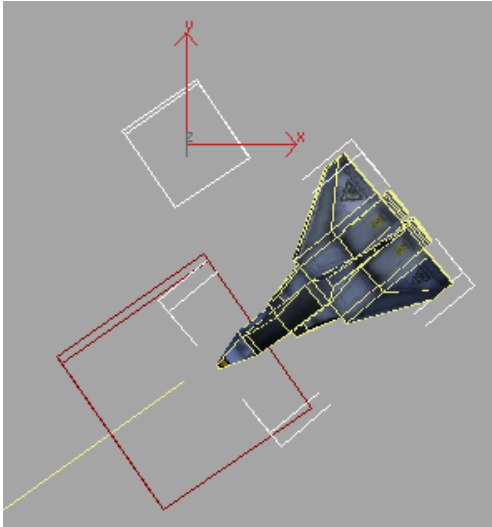

7. On the Motion panel, open the Assign Controller rollout, if it's not open, and select the Rotation: Euler XYZ controller.
8. Click the Assign Controller button and choose TCB Rotation from the Assign Rotation Controller dialog.

Note: If you don't assign the TCB Rotation controller, you will not be able to rotate *wingmanroll* about a local axis.

9. Select *Wingman02* in the Top viewport.
10. Open the Animation menu and choose Constraints > Orientation Constraint. Move the cursor over *wingmanroll* and select it.
You'll see *wingmanroll* added to the Orientation Constraint target list in the Orientation Constraint rollout on the Motion panel.

11. Select *wingmanroll* in the Top viewport.

12.   Turn on the Set Key toggle and click the Set Key button.

13.  Move the time slider to frame 60 and click Set Key again.

You've added two keys that will keep *Wingman02* flying normally from frames 0 to 60.

14. Activate the SpaceCam viewport and move the time slider to frame 85.

15.  Click Select And Rotate and change the Reference Coordinate System to Local.

16. You'll make two rotations during this step:

- Enter **-15** in the X-axis Coordinate Display Type-in field and click the Set Key button.



- Enter **90** in the Y-axis Coordinate Display Type-in field and click the Set Key button.



17. Move the time slider to frame 100 to make the next two rotations:
- Rotate **5** degrees around the Z-axis and click the Set Key button.
 - Rotate **90** degrees around the Y-axis and click the Set Key button again.
18. Move the time slider to frame 115 to make the next two rotations:
- Rotate **10** degrees around the Z-axis and click the Set Key button.
 - Rotate **90** degrees around the Y-axis and click the Set Key button again.
19. Turn off the Set Key toggle when you've finished. Save the scene as **MyFlight06.max** and play the animation.

Taking Control of Mars, Its Moons, and the Space Station

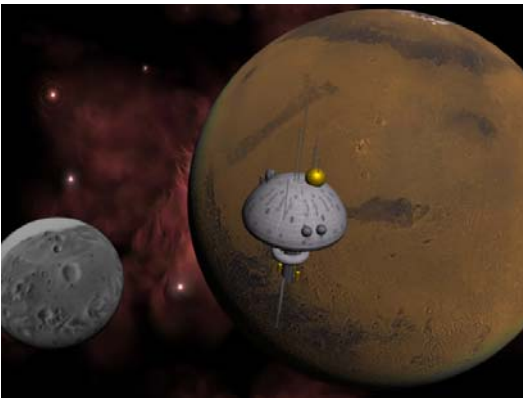

So far, you've used dummy objects to help animate the spacefighters. Another handy use of dummy objects is as an alternate pivot point. Any object

could be used, but dummies are great because they don't render.

Set up the lesson:

- Load the *spacestation.max* file.

Files for this lesson are in the *tutorials\intro_to_animation* folder.

This scene includes the following:

- Three heavenly bodies, *Mars* and its two moons, *Deimos* and *Phobos*
- A space station named *SpaceStation*
- A camera (hidden) named *SpaceCam*

Take a few moments to familiarize yourself with the names of the objects in the scene. This will make it easier for you to select objects during this lesson.

Rotate Mars and its moons:

The first part of this lesson focuses on the three heavenly bodies you see in the scene. You will set up a dummy object to control the rotation of Mars and its moons, Deimos and Phobos.

1. In the Left viewport, create a Dummy object around Mars. Name the dummy object **MarsControl**.

Make the dummy a little larger than the planet so it's easier to pick.

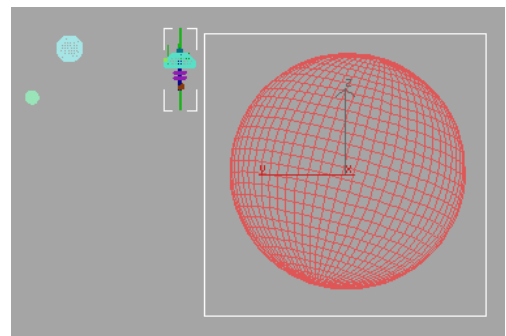

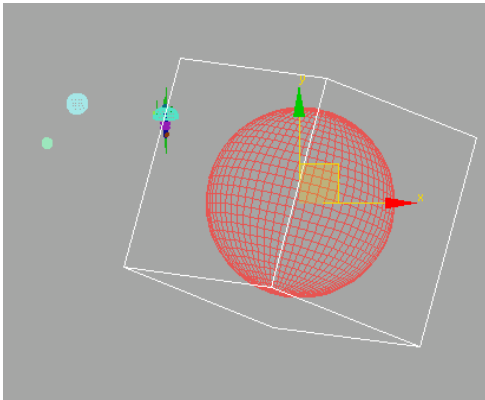

2. With the dummy object still selected, choose Tools menu > Align, and click *Mars*.
3. In the Align Selection (Mars) dialog, do the following:
 - Turn on X, Y and Z Position in the Align Position (Screen) group.
 - Turn on X, Y and Z Axis in the Align Orientation (Local) group.
 - Click OK to accept the settings.

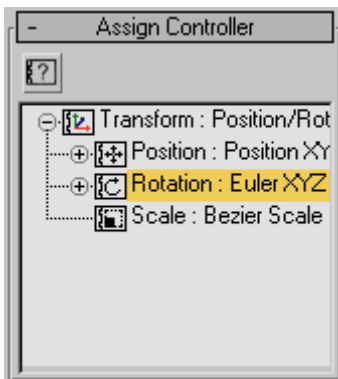

MarsControl is now aligned and oriented with the center of Mars.

4. Select *MarsControl*.
5. Go to the Motion panel, and expand the Assign Controller rollout. Select Rotation: Euler XYZ.



6.  Click the Assign Controller button and choose TCB Rotation then click OK.

TCB Rotation will allow you to rotate objects on their Local axes as opposed to the World axes. This is beneficial when you have an object that is rotating on an axis that is tilted, such as the rotational axis of a planet.

7.  Select *Mars*, then click Select and Link. Drag the rubber band to *MarsControl*. Release the mouse button when the cursor changes.

8.  Link each of the moons, Deimos and Phobos, to *MarsControl*.

Mars and its two moons are now linked to MarsControl. Any movement or rotation you make to MarsControl will affect all the planetary bodies.

9.  Click Select And Rotate, and select *MarsControl*.

10.  Change the Reference Coordinate System from View to Local.

11.  Turn on the Auto Key button and move the time slider to frame 100.

12. In the Z axis field, below the time slider, enter 60.

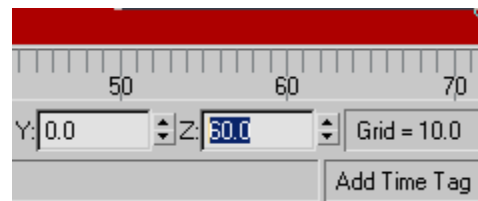

This rotates MarsControl by 60 degrees around its local Z axis. Because the planet and moons are linked to MarsControl, they also rotate.

13. Turn off the Auto Key and save your work as **MySpaceStation**.

14. Activate the SpaceCam viewport and play the animation.

You will see Mars rotating on its axis, then at frame 60, Deimos swings into view and passes by and Phobos remains off-camera. If you like, you can zoom out to see both moons during playback.

15. Return the time slider to frame 0 before continuing.

Set the space station into orbit:

Now that Mars is spinning on its own axis and Deimos and Phobos are orbiting Mars, you can set the space station into a geosynchronous orbit around Mars (an orbit that matches the planet's rotation). You'll use the same technique for controlling the space station.

1. Add a new dummy object to the Top viewport, and name it *StationControl*.

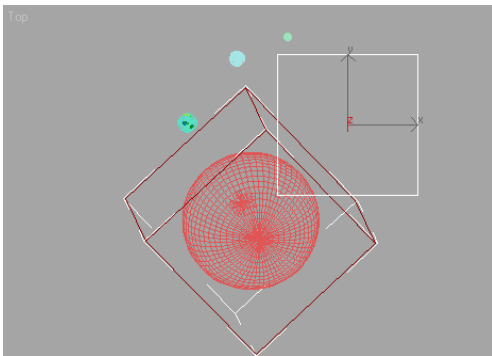

It doesn't matter where you place the dummy object, because you'll align it to Mars in a few steps.

2. Open the Assign Controller rollout on the Motion panel, and select Rotation : Euler XYZ.

3.  Click the Assign Controller button, and choose TCB Rotation. Click OK.

4. While StationControl is still selected, choose Tools menu > Align, and click *Mars*.

5. In the Align Selection (Mars) dialog, do the following:

- Turn on X, Y and Z Position in the Align Position (Screen) group.
- Turn on X, Y and Z Axis in the Align Orientation (Local) group.
- Click OK to accept the settings.

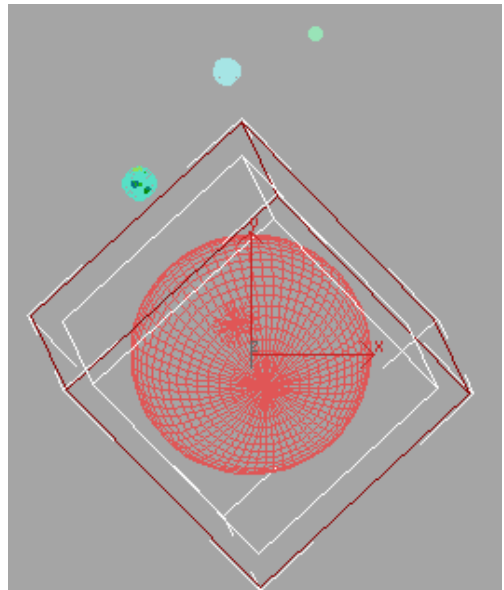

These are the same settings you made when aligning MarsControl to Mars in the previous section.

6.  In the Left viewport, link *SpaceStation* to *StationControl*.

7.  Turn on Select And Rotate and select *StationControl*. Change the Reference Coordinate System from View to Local, if it's not already changed.

Tip: You must always choose the transform (in this case, Select and Rotate) before choosing

the Reference Coordinate System. Different transforms can have different Reference Coordinate Systems. If you choose the coordinate system first, it might change when you choose a different transform.

8. **Auto Key** Turn on the Auto Key button and move the time slider to frame 100.
9. In the Z axis field, below the time slider, enter 40.

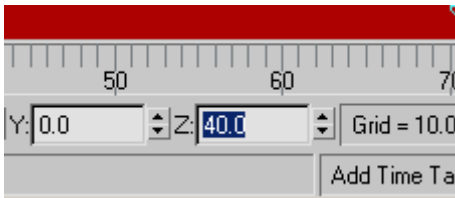

10. Turn off the Auto Key and save your work as **MySpaceStation01**.

To create an incrementally saved file, use the Save As command click the  button.

11. Play the animation.

Now the Space Station is orbiting around Mars but it's orbiting at a slower rate.

Add artificial gravity to the space station:

The space station need to rotate around its own axis in order to generate some level of artificial gravity for its personnel. This last section will solve that problem.

1. In the SpaceCam viewport, select *SpaceStation* and open the Motion panel.

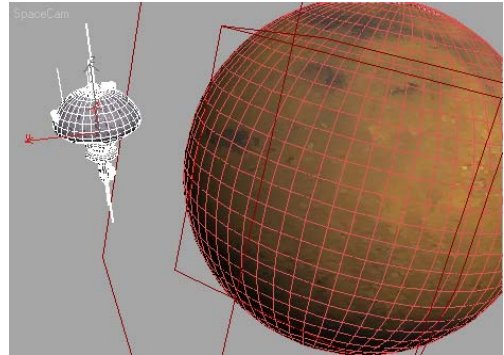

2. Open the Assign Controller rollout and select Rotation : Euler XYZ.

3.  Click the Assign Controller button and choose TCB Rotation then click OK.

4.  Turn on Select And Rotate if it's not already active. Set the Reference Coordinate System from View to Local.

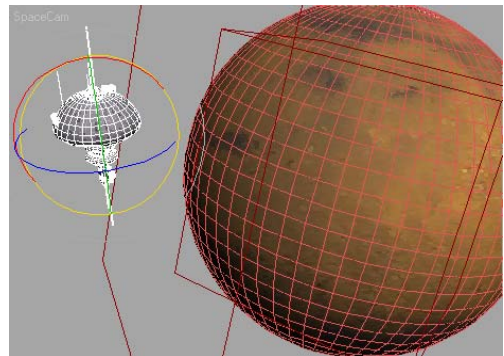

5. **Auto Key** Turn on the Auto Key button and move the time slider to frame 100.
6. In the Z axis field, below the time slider, enter 90.

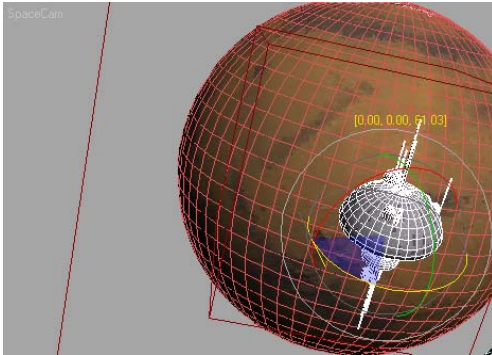

7. Turn off the Auto Key.
8. Play the animation.

Now the Space Station rotates about its own axis while it's in geosynchronous orbit around Mars. Maximize the SpaceCam viewport for a better view.

9. Save your work as **MySpaceStation02**.

Animating the Spaceship Using XRefs

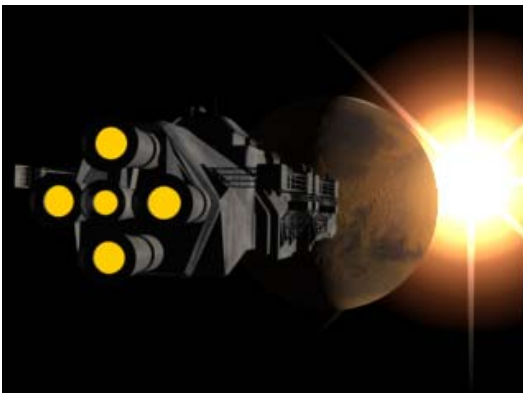

3ds Max lets you quickly and easily animate directly in the viewports. You can play your animation and get feedback on timing and movement without having to render.

This remains true until you start using really big models, and then performance can start to slow

down. You can get around this by using XRefs, which are externally referenced files. In this tutorial, you'll animate a low-polygon spaceship as a proxy for a very detailed spaceship that will only be used when rendering the final animation.

You won't use the same spaceship that you just made; instead you'll use a highly detailed model of a battleship.

XRef Hi-Poly object into scene:

1. Reset 3ds Max.
2. Open the file *marsandsun.max*.
Files for this tutorial are in the *tutorials\intro_to_animation* folder.
Note: If you see the [File Load: Units Mismatch dialog](#), choose the option Rescale The File Objects To The System Unit Scale.
3. Choose File menu > XRef Objects.
4. In the XRef Objects dialog, click Add.
5. In the Open File dialog, navigate to the *tutorials\intro_to_animation* directory and locate *battleship.max*. Highlight this file in the list and click Open.
The XRef Merge dialog is displayed. This dialog lists the objects in *battleship.max*. There are two objects here. One is a highly detailed battleship, the other is a low-poly proxy version of the ship.
Note: The proxy object doesn't have to be in the same 3ds Max file as the high-resolution object. This just happens to be the case in this lesson.
6. Choose *Hi Poly BattleShip*. Click OK.
The *battleship.max* file and its path are listed in the upper window of the dialog; the *Hi Poly BattleShip* object appears in the lower window.
7. Close the XRef Objects dialog.

You have just added the battleship as an XRef object in the scene. This object has almost 100,000 faces.

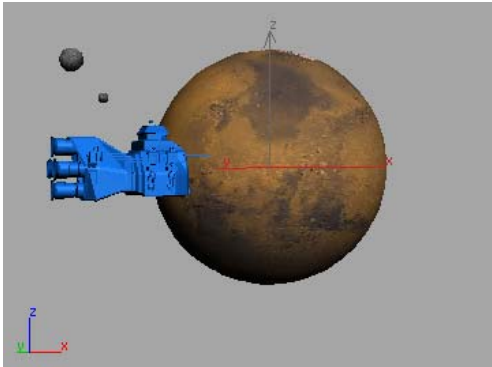

Don't worry. The battleship will be moved soon.

XRef Low-Poly object into scene:

1. Select the battleship.
2. Open the Modify panel. Look at the modifier stack for the object.

Nothing is listed in the stack except XRef Object. You can add modifiers to the object, but you can't make any changes to the XRef object itself.

3. In the XRef Object rollout, in the XRef Viewpoint Proxy group, click the File Name browse button. (The button with three dots located under the File Name field. Don't confuse this button with a similar one in the XRef group.)
4. Choose *battleship.max*. Click Open.
5. Highlight *Low Poly BattleShip* and click OK.

The low-resolution proxy is displayed in the viewport. The battleship name is displayed in the Object Name field. Use Proxy is automatically toggled on.

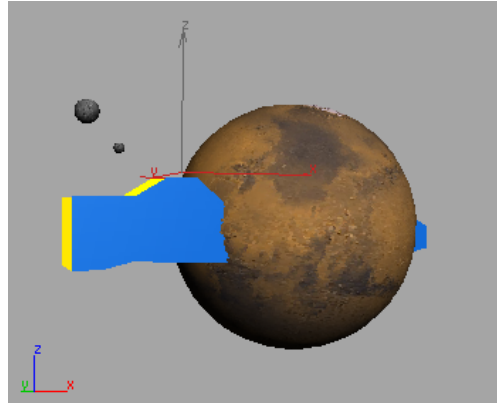

The proxy battleship will also be moved soon.

Animate and render with xref objects:

1. Activate the Top viewport and zoom back a bit.
2. On the Display panel, in the Hide by Category rollout, turn off Cameras.

The camera now appears in the viewports and it's pointing at Mars.

3. In the Top viewport, move the proxy battleship object down and left so that it's at the bottom left of the viewport. Rotate the proxy battleship so that it points toward Mars.
4. Move Camera01.Target so it's pointing at the proxy battleship.

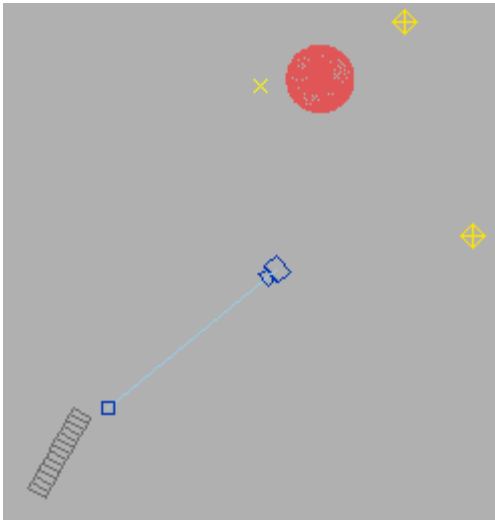

You should be able to see the battleship in the Camera01 viewport.

5. Turn on Auto Key.
6. Move the time slider to frame 100.
7. Move the proxy battleship closer to Mars.
8. Move the camera target so the camera looks at the battleship.

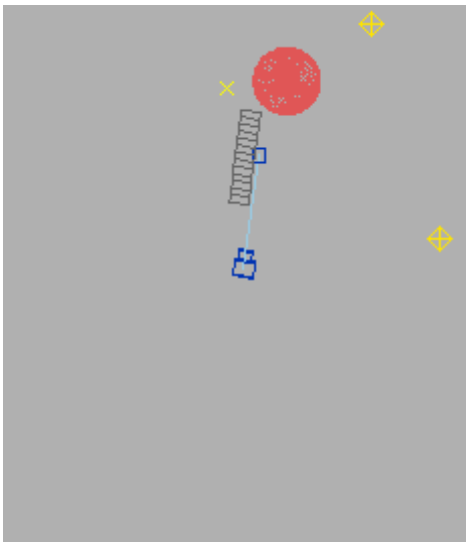

9. Turn off Auto Key.
10. Play the animation in the Camera01 viewport.
11. Go to frame 100. Render the Camera viewport.

Although the proxy battleship is visible in the viewport, the high-resolution model is rendered in the final output. The scene features a lens flare behind the planet.

Note: If the texture maps seem to be missing on the ship, go to the Modify panel > XRef Object rollout > Options group. Turn on Update Material and render again.

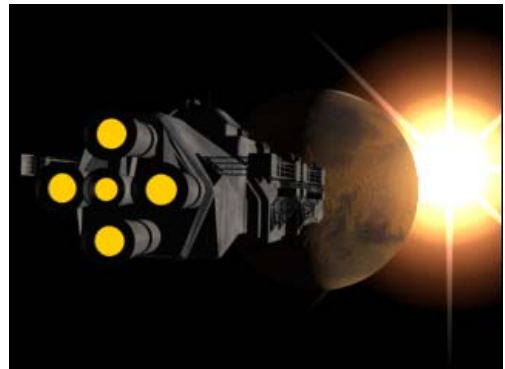

Rendered image of the hi-poly spaceship with a sun flare in the background

For more information about the lens flare effect, see *Creating the Sun with a Lens Flare (page 1-474)* tutorial.

Summary

Among the animation tools you can use is the path constraint. With this feature, you can make an object follow a path partially or fully. When objects are complex and take up a lot of system resources, you can use the Xref feature to bring a low-resolution proxy into the scene.

Animating a Pen

A client asks for an animation of a pen writing the word “yes” onto a page. You already know how to model the pen, but how do you animate it so that it follows a path? And how do you make the writing appear synchronized with the movement of the pen? These questions and others will be answered in this tutorial for a write-on animation.

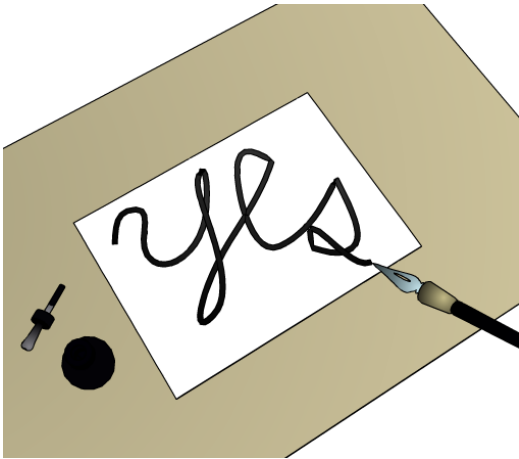

Skill Level: Beginner

Time to Complete: 15 minutes

Features Covered in This Tutorial

In this tutorial you will learn:

- Drawing splines on objects using snaps
- Using path constraints
- Using path deform modifiers

Tutorial Files

Files for this tutorial can be found on the Tutorial Files CD in the `|tutorials|intro_to_animation` directory. Before starting the tutorials, copy the `|tutorials` folder to your `|3dsmax8` directory.

Drawing the Path on the Paper

We won't take you through the entire process of modeling a scene. Instead, you'll open a file that is already developed. The pieces are all ready, so you can focus on animation.

Setup:

- On the menu bar, choose File > Open and navigate to `|3dsmax8|tutorials|intro_to_animation|write_on_start.max`. Highlight the file name, then click Open.

Note: All the necessary files to do the tutorials can be found on the Tutorial Files CD that ships with 3ds Max 8. Before doing the tutorials copy the `|tutorials` directory from the CD to your `|3dsmax8` local installation.

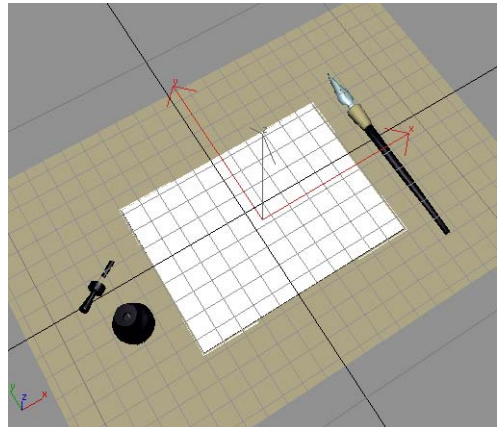

The sample file, `write_on_start.max`.

You see a piece of paper on a drawing board, and a pen and a bottle of ink on either side. The camera zooms back to frame a better view of the paper.

Before you draw the path, you'll change the color of the paper to black. This will make it much easier to see the line as you draw.

Change the paper color:

1.  On the toolbar, choose Select By Name.
2. In the Select Objects dialog, highlight *paper* in the list on the left, then click Select.

The paper object is selected in the viewport, and its parameters are visible in the Modify panel on the right.

3. On the toolbar  click the Material Editor button to open the Material Editor.

The Material Editor displays the materials used in the scene. The paper material sample sphere is highlighted and should be visible.

4. Click the Black material on the second row. The material name *Black Paper* appears next to the eyedropper.

5.  On the Material Editor toolbar, click Assign Material To Selection. The paper is now black.

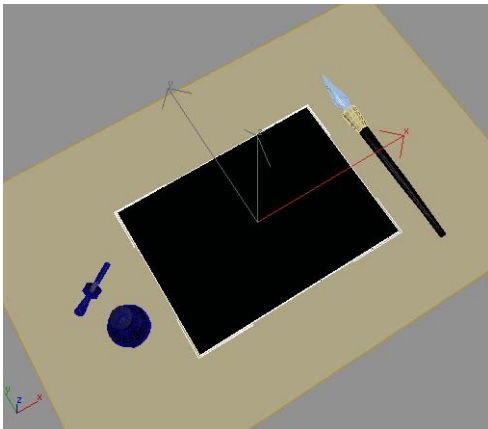

Black paper makes it easier to see the lines you draw.

While you still have the paper selected, you'll make one more change.

Add segments to the paper:

1. Close the Material Editor, then right-click the viewport label, and choose Edged Faces. This shading mode displays shaded faces and edges.
2. On the Modify panel, in the Parameters rollout, increase the Length Segments and Width Segments of the paper object to **8**.

The black paper segments are now visible in the viewport.

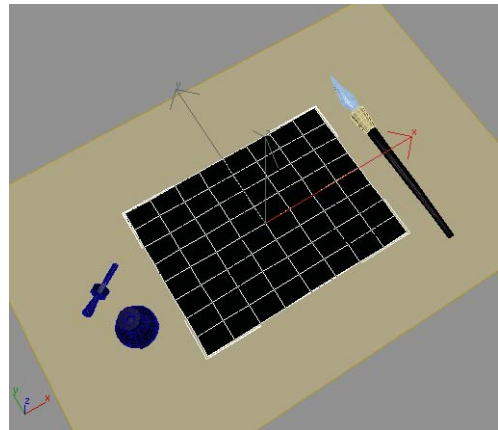

Increased box segments

You will snap to the faces on the black paper when you draw the line.

Use snaps with lines:

1. On the Customize menu, choose Grid and Snap Settings. On the Snaps panel, click Clear All and turn on Face, then close the dialog using the X at the upper right.

All the setting up is done; now it's time to draw the word *yes*.

2.  On the toolbar, turn on 3D Snap.

Tip: You can also press **S** to turn snap on and off during creation operations.

3.



On the Create panel click the Shapes button, then in the Object Type rollout, click Line.

4. Move your cursor over the black paper. As you move, you'll see the snap-face cursor showing you which face you are snapping to. Click to set the first point, then move your cursor to the right and up. You'll see the snap cursor again.

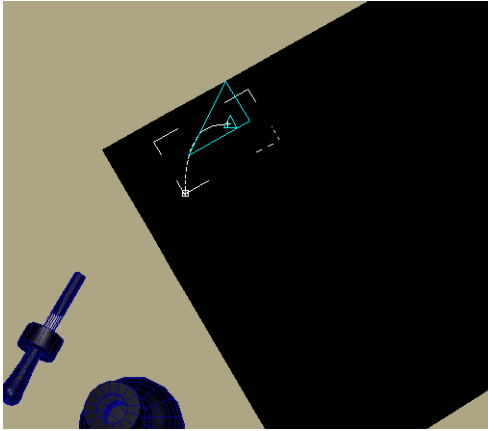

Snap To Face cursor

5. Click and drag to create a rounded spline. Move the cursor, and click and drag again to create another rounded spline. Place points to create the letter Y. (In the Illustrations that follow, we've turned off the snap cursor so you can see the point placement better.)

Tip: Pressing the BACKSPACE key while drawing will delete the last-placed vertex in the line. You can also adjust the vertices later.

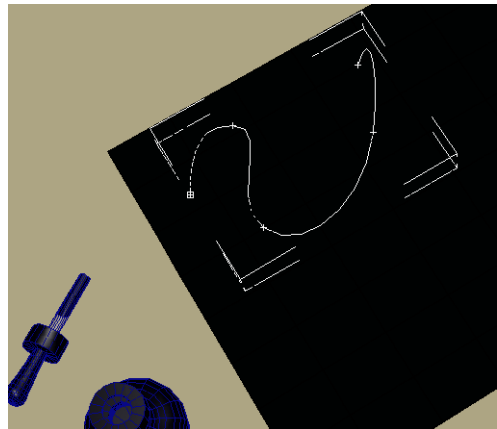
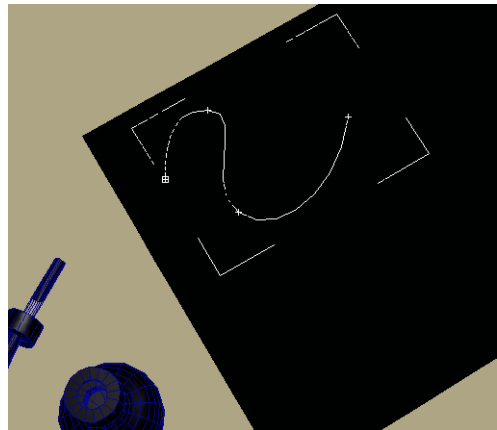
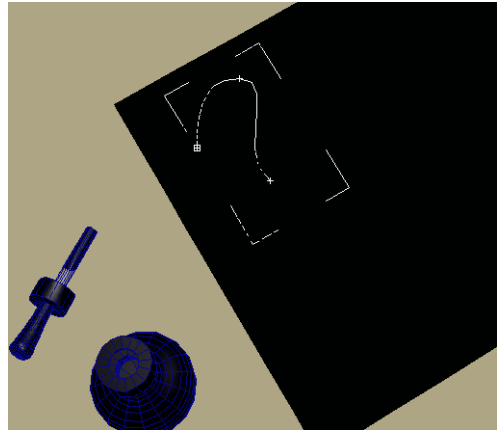

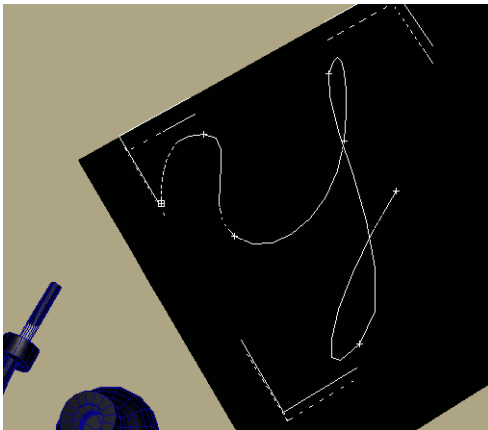
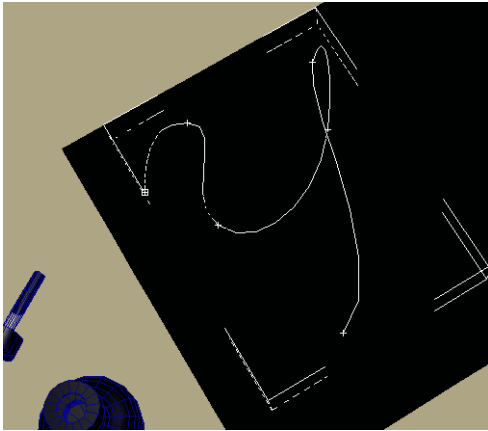

Click and drag to create rounded splines.

You can see the flat line segments that are used to create the splines, particularly obvious in the tail of the Y. Don't worry about these, you can increase the segmentation later to create a smoother line.

Create sharp corners:

1. When you want to create a sharp corner, just click, rather than clicking and dragging. For example, when you come to the letter *e*, you'll need a sharp corner, as well as in the letter *s*. To stop creating line segments, right-click.

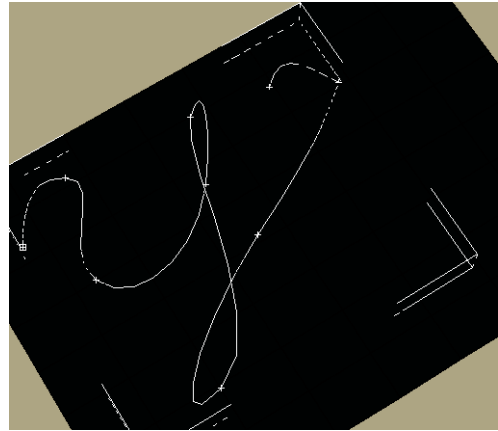

For the corner of the letter e, make a sharp corner by just clicking.

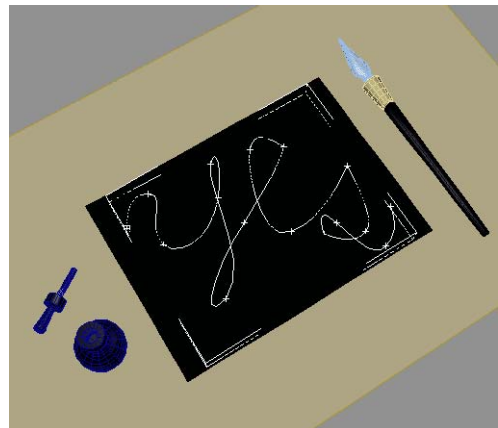

Right-click to finish.

2. Right-click the viewport to turn off the Line Shape tool.
3. Save your work. On the menu bar, choose File > Save. Name your file **my_write_on.max**.

Animating the Pen on the Path

Now that you've drawn the path on the paper, you can animate the pen using a path constraint.

Setup:

1. Continue from before or open *write_on_yes.max*.
2. Move the time slider to Frame 0, if it isn't there already.

Change material and color:

1. Press **M** on the keyboard to open the Material Editor, if it isn't open already. Locate the material named *paper*, and drag it onto the paper object in the viewport.
2. Press the **H** key or choose  Select By Name from the toolbar.
3. In the Select Objects dialog, select the object named *Line01*, then click Select.
4. On the Modify panel, in the Name And Color field, click the color swatch, and then change the color of the line from white to black.
5. Click in open space in the viewport to deselect the *Line01* object.

The line is visible in the viewport now.

Animate the pen with path constraints:

1. Press the **H** key again. In the Select Object dialog, choose the object named *nib* from the list. At the bottom of this dialog, click Display Subtree. Click Select.

The components of the pen (the wood, the cork, and the nib) are already linked into a hierarchy for animation. This is indicated by the indented list. The nib is the parent of the hierarchy. When you animate the nib parent object, the cork and the wood child objects will follow.

The pen nib is now selected in the viewport.

2. On the menu bar, choose Animation > Constraints > Path Constraint.

As you move your mouse over the viewport, you'll see a dotted line connecting your cursor to the nib.

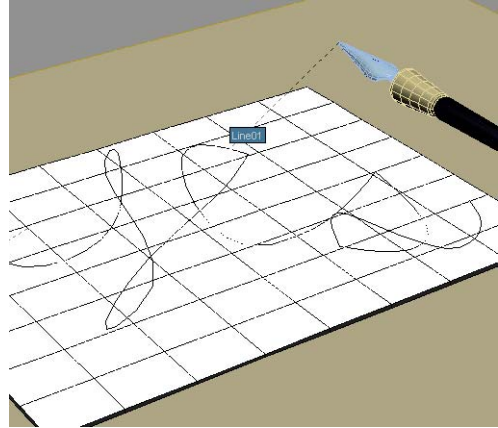

3. Move your cursor to the *Line01* object, then click to select that as the path.

The pen jumps to the start of the path. It is also buried in the paper.

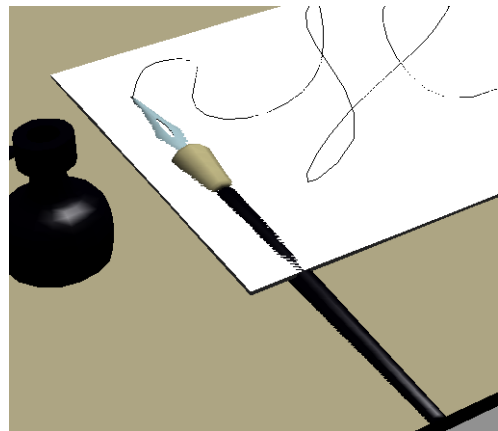

Pen jumps to the start of the path.

4.  On the toolbar, turn on Rotate Mode. Rotate the pen in the viewport, approximately **-30** degrees about X, and **17** degrees about Z, so the pen is not buried in the paper.

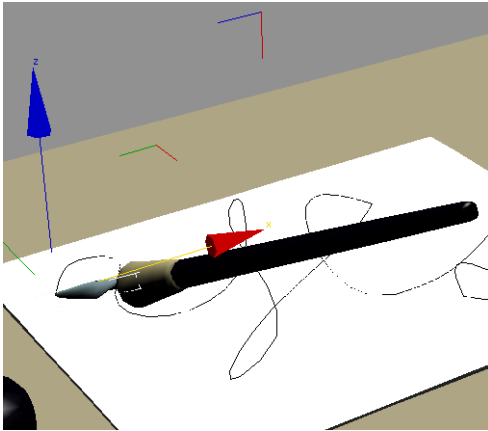

Rotate the pen so that it's above the paper.

5. Play the animation. The pen follows the path.

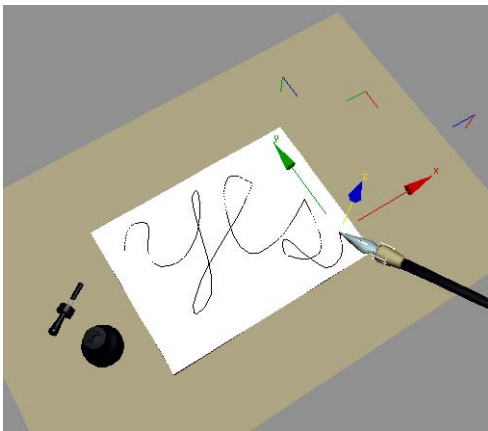

Pen moves along the path.

The next order of business is to create a growing line to follow the end of the pen. To do this, you will use a PathDeform modifier.

Creating the Line Using PathDeform

The PathDeform modifier takes an object and stretches it along a path. By animating the amount of stretch, you can use it to create the effect of a line growing over time.

1. Continue from before, or choose File > Open, then open `|3dsmax8\tutorials\intro_to_animation\write_on_growline.max`.
2. Use Arc-rotate to navigate the perspective viewport to give you a more frontal view of the objects in the scene.
3. On the Create menu, choose Standard Primitives > Cylinder.
4. On the Object Type rollout, turn on Auto Grid.
5. Drag out a cylinder over the start of *Line01*. It doesn't have to be very wide.

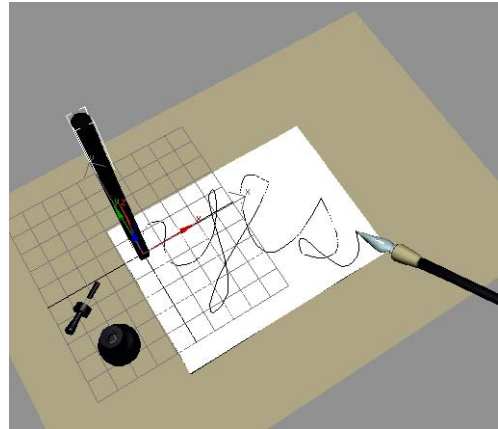

Create a cylinder over the start of the line.

6. In the Parameters rollout, set the following values:
 - Radius=**0.03**
 - Height=**2.5**
 - Height Segments=**133**
 - Sides=**4**

These values will give the cylinder enough segmentation to stretch over the path. Before you create the path deform, you'll hide the paper, so it'll be easier to see the new object.

7. Select the paper in the viewport, then right-click and choose Hide Selection from the quad menu.

The paper disappears from view.

8. Select the Cylinder, and then on the menu bar choose Modifiers > Animation Modifiers > PathDeform.

The Path Deform rollout parameters appear in the Modify panel.

9. On the Parameters rollout, click Pick Path, then click the line in the viewport.

The cylinder deforms in the viewport into the first few bends of the letter Y. However, it is rotated along its Z axis. Later, you'll rotate the cylinder so that it lies on top of the line.

10. On the Modify panel, in the Parameters rollout, increase the Stretch value to **3.62**, or until the deformed cylinder extends just to the end of the line. Move the time slider to frame 0, right-click and choose Move from the quad menu. Using the Transform gizmo, raise the deformed cylinder up in Z until you can see it clearly.

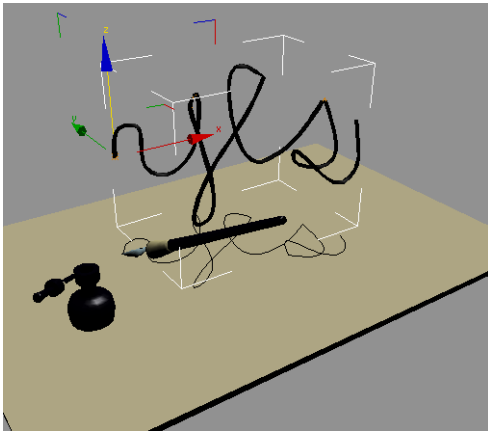

11. Navigate the Perspective viewport to see how the path deform is positioned. Press **SHIFT+Z** to undo the viewport changes.

Tip:  Press Arc-rotate to arc-rotate the view.

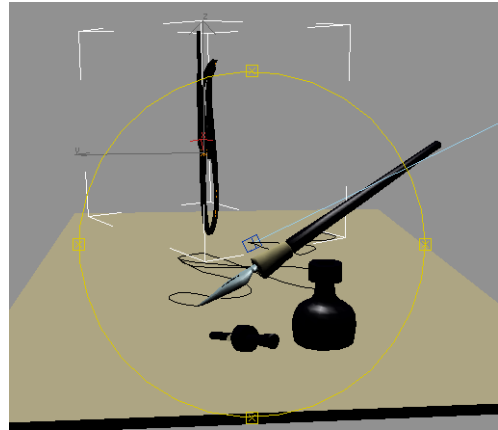

Arc-rotate the Perspective viewport to see the cylinder's orientation.

12. Right-click and choose Rotate from the quad menu, then rotate the deformed Cylinder about the X axis **-90** degrees.
13. In the Front viewport, check that the logo appears parallel to the paper. If not rotate it as necessary until it is.
14. Move the cylinder down in the Front viewport so it's visually aligned with the pen.

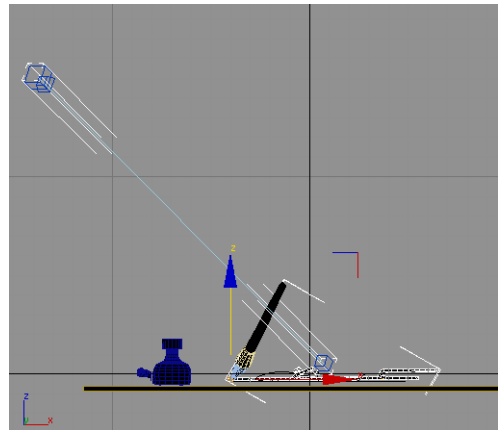

Use the Front viewport to adjust the cylinder's position.

15. In the Top viewport, right-click and choose Rotate from the quad menu. Then rotate again

until the corners of the letters “e” and “s” line up with *Line01*.

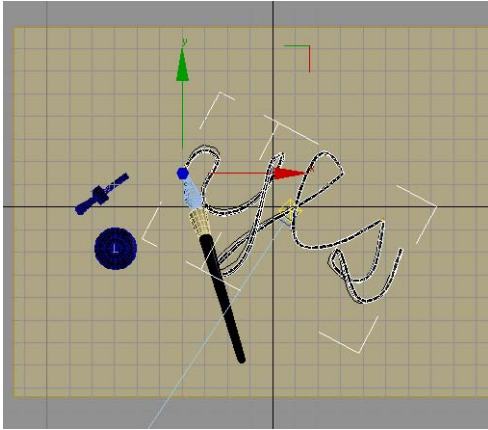

16. Activate the Perspective viewport, then move the Cylinder down slightly to finish aligning the object with the path.

Note: Depending on how you drew your line, you may have to make adjustments to get the object to line up with the path. You can make adjustments visually until it is correct.

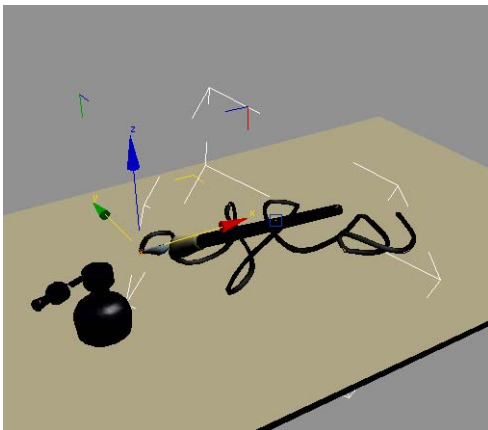

Aligned path-deformed cylinder

Next, you'll keyframe the stretch so the line grows.

Keyframe the stretch:

1. Turn on the Auto Keybutton. Set the Stretch to **0.1**.
2. Move to frame 100, then adjust the stretch so it coincides with the end of the pen. Try a Stretch value of about **4.4**.
3. Move the time slider to frame 0, and play the animation.

You'll notice the line and the pen are not in perfect synchronization.

4. Move to frame 10 and adjust the Stretch value of the path so the line meets the end of the pen.

Tip: Use the spinner to adjust the Stretch value.
5. Repeat at 10 frame intervals until you get to frame 100. Play the animation again.

6. To get it just perfect, go back to frame 0 and then move forward in time using the > key. Whenever you see the path out of sync, adjust the Stretch value and set a key. The keys will be visible on the track bar. You'll probably need to set keys every 5 or 10 frames.

Tip: There are more mathematical ways to approach this process, such as applying a Normalize Spline modifier to the line, but for an artist this method gets the job done using visual means.

7. Unhide the paper, and hide *Line01*, then play the animation.

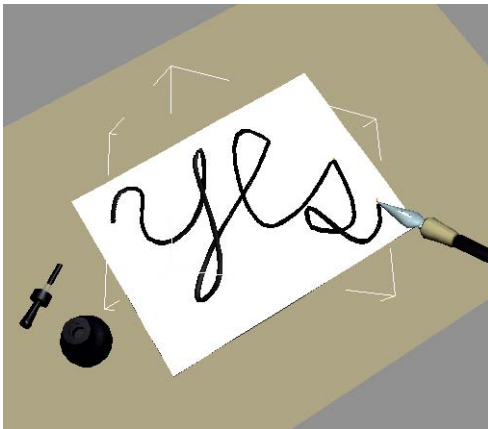
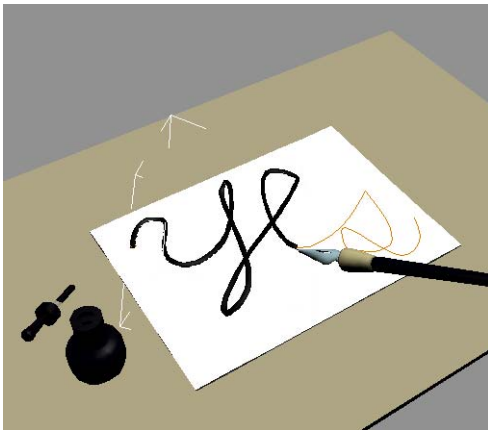
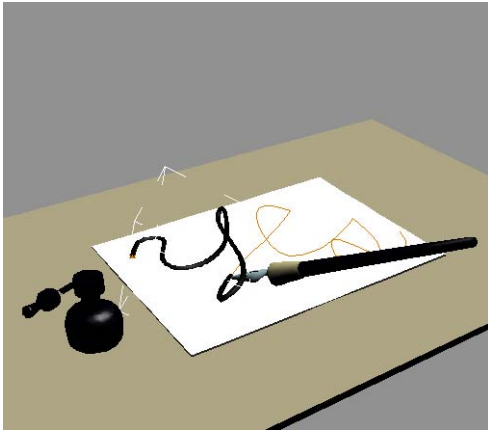

Pen writes onto the paper.

8. Save your work as **mywrite_on_yes_anim_complete.max**.

You can open *write_on_yes_anim_complete.max* for comparison.

Summary

In this tutorial, you have learned to create animation using path deform. You have learned to draw a line on an object by snapping to faces, then use that line as a path for the animation of the pen. The same line was used as the path deform path to create the illusion of the line being drawn on the page. By animating the stretch parameter and synchronizing it with the animation of the pen, the illusion is complete.

Working with Animation Tracks

Working with Animation Tracks

In this tutorial, you will animate the second, minute and hour hands of a clock. You will learn how to create keyframes in a variety of ways and prepare a set of animation tracks for later recall.



Features Covered in this Tutorial

- Creating a Track Set
- Using Auto Expand
- Trackview Quad Menu
- Hierarchy Right-Click Menu
- Default In/Out Tangents for new keys
- Zoom Key Extends
- Setting Parameter Curve Out of Range Type
- Copying Controllers

Skill Level: Intermediate

Time to Complete: 30 minutes

Form a Track Set

1. Open *Watch1.max* from the `|tutorials|curve_editor` folder. If you get a Units Mismatch warning, choose the option “Adopt the File’s Unit Scale”.
2. Right-click in the viewport and from the Quad menu, choose Curve Editor.
3. Open the hierarchy so that the rotation Z-axis tracks for each of the hands can be seen.
4. Press Ctrl and select each of the three Z Rotation tracks.
5. Create a Track Set by entering Hands in the Track Sets field.

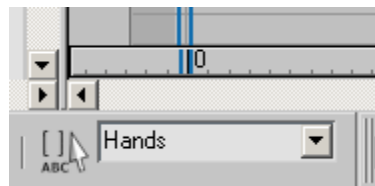
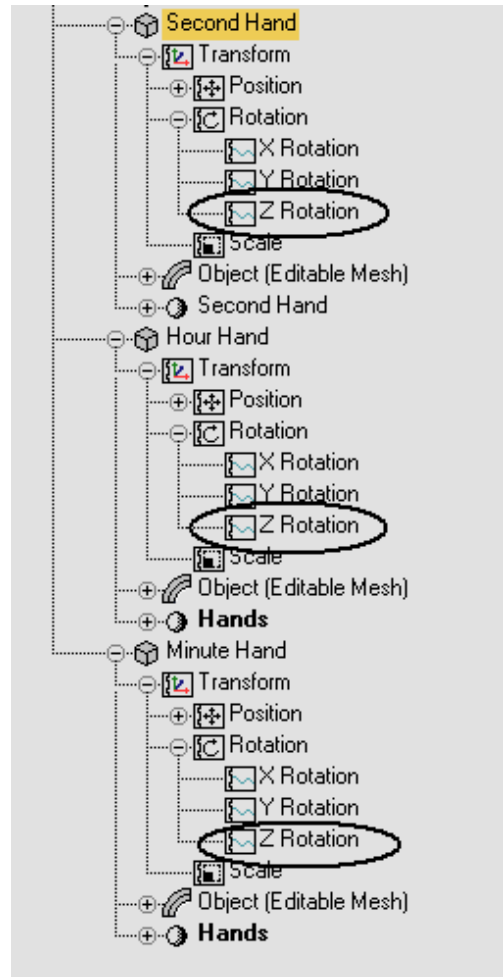

This Track Set can be recalled to conveniently display the included tracks within the Curve Editor.

6. Close Curve Editor

Animate the Second Hand

The second hand will be animated so that it rotates one second per frame.

1. Press H to open the Select by Name dialog.
2. Highlight the Second Hand in the list and click Select to select it.

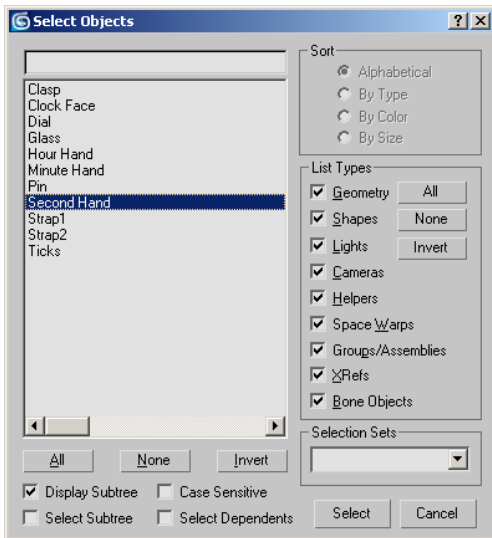

3. Right-click and choose Curve Editor from the Quad menu.
4. Right-click in the pane displayed on the left to open the Quad menu.
5. Within the Auto Expand sub menu, make sure the following options are active.

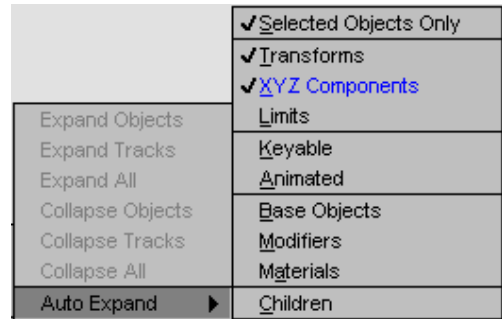

These options display the X, Y, and Z components of the transform tracks.

6. Highlight the Second Hand's the Z Rotation track.



7. Click Add Keys.

8. Click near frame 0 and again near frame 1 to add some keys. Don't worry about setting the values exactly at this point. You'll adjust them in a moment.
9. Right-click and choose Move Keys from the Quad menu. This cancels Add Keys mode.

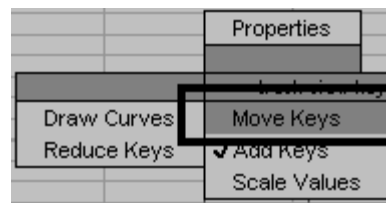

10. Click the first key and set its time and value to zero.

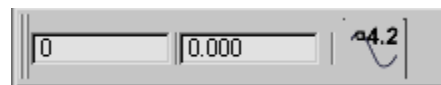

11. Click the second key and set its time to 1 and value to -6.

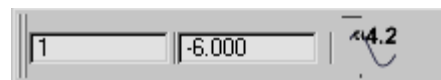

12. Close the Curve Editor.

Setting Key Tangent Type

1. Open *Watch2.max* or continue with your current file.
2. Select the Second Hand and open Curve Editor.
3. Highlight the Z Rotation track.

4.  Click Zoom Horizontal Extents Keys.

Note: It is contained within the Zoom Horizontal Extents flyout.

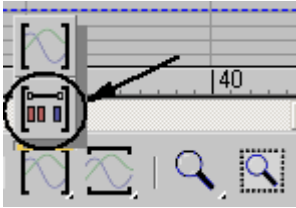

5.  Repeat the Procedure with the Zoom Value Extents Range (vertical zoom).

The Curve editor zooms in to show only the range with keys, which in this case is frame 0 and 1.

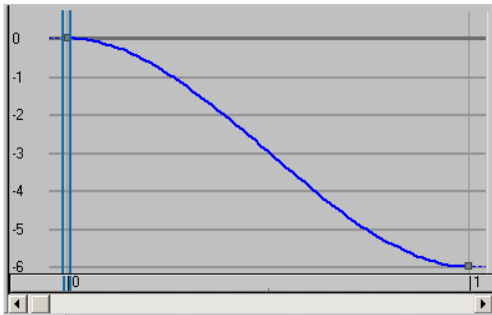

The curve uses the default Auto tangent type. The tangent type should be set to Step.

6. Select both keys using a window selection.

7.  Click Set Tangents to Step on the Curve Editor's toolbar. This retains a key's value until the next key frame.

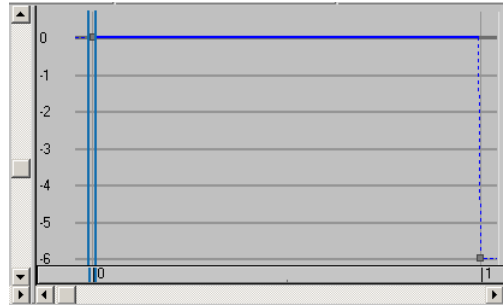

Setting Parameter Curve Out-of-Range Type

To make the second hand repeat its motion the Out-of-Range type should be set to Relative Repeat.

1.  Click Parameter Curve Out-of-Range Type.
2. Click the Relative Repeat option.

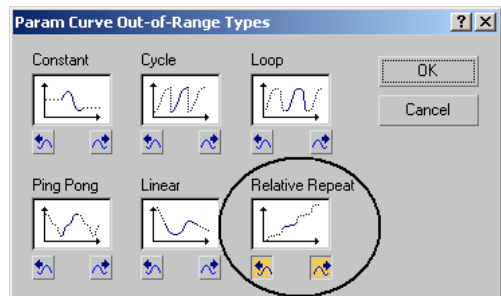

3. Click OK to close the dialog.
4. Close the Curve Editor.
5. Play the animation.



The second hand repeats its motion throughout the animation range.

Animate the Minute Hand

The second hand moves in steps, jumping ahead each second. The minute hand however should move continuously. This can be accomplished with the linear key tangents.

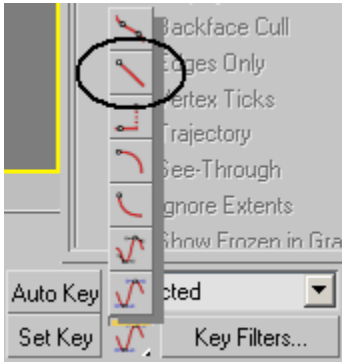
1. Set the default tangent type to linear.



2. Move the time slider to frame 60.
3. Open the Select by Name dialog and select the minute hand.
4. **Auto Key** Click Auto Key.
5.  Click the Rotation tool.
6. Enter -6 in the Z transform field and press enter.
 
7. Turn off Auto Key.
8. Open the Curve Editor
9. Select the Z Rotation track of the Minute Hand.
10.  Click Parameter Curve Out-of-Range Type.
11. Set the Parameter Curve out of Range type to Relative Repeat.

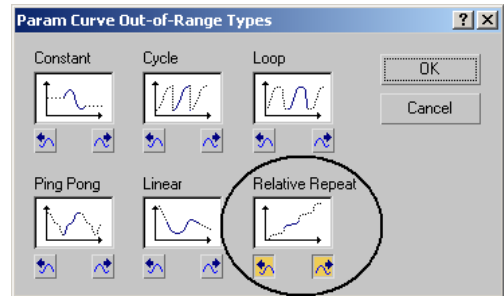

12. Close the Curve Editor.



Play the animation.

The second and minute hands move correctly. Next you'll animate the hour hand.

Copying Controllers

In this sequence you'll animate the hour hand by copying and adjusting the controller from the minute hand.

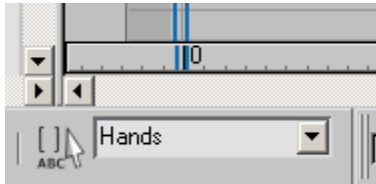
1. Open *Watch3.max* or continue with your current file.
2. Right-click in the viewport and select Curve Editor.
3. Choose Hands from the Track Set list.
 
4. Highlight the Z-Rotation track of the Minute Hand.
5. Right-click and choose Copy from the Quad Menu.

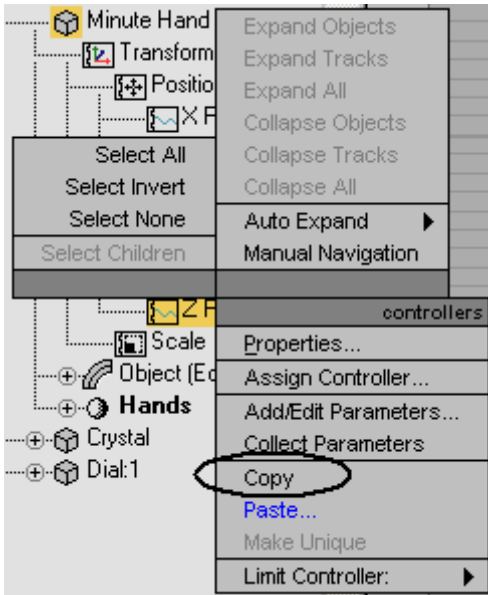

6. Highlight the Z Rotation track of the Hour Hand.
7. Right-click and choose Paste from the menu.

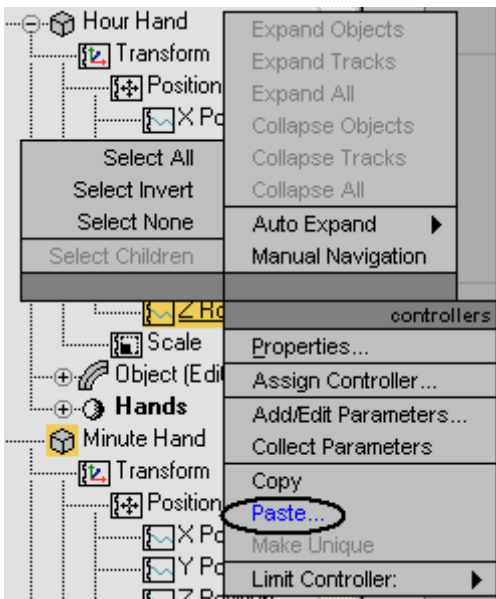

8. Choose Copy from the dialog.

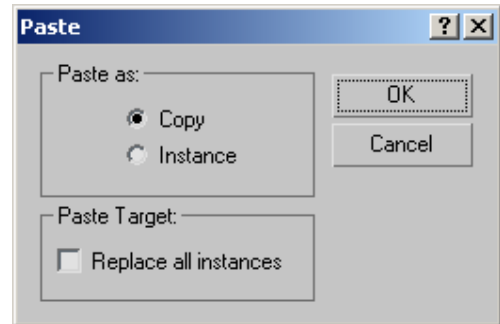

9. Make sure the Z Rotation track of the Hour Hand is the only highlighted track.
10. Select the second key of the Hour Hands Z Rotation track.



11. Adjust the value at frame 60 from -6 to -0.5.

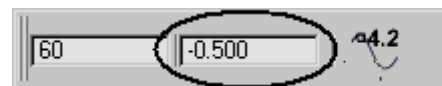

12. Close the Curve Editor.



Play the animation.

Although the hour hand is animated you can't see it move until the animation time is extended.

Extending the Animation Time

1. Open the time configuration dialog.
2. Set the end time to 3600.

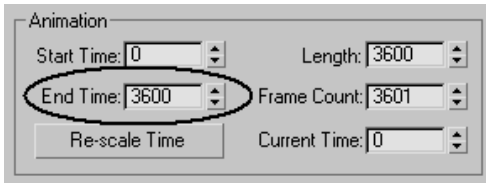

3. Click OK to close the time configuration dialog.
4. Drag the time slider to view the animation. One hour elapses over the course of the animation.

Summary

In this tutorial, you learned how to animate the second, minute and hour hands of a clock. You also learned how to create keyframes in a variety of ways and prepare a set of animation tracks for later recall.

Animating a Walkthrough

Animating a Walkthrough

When you create a camera in 3ds Max, you can “fly” that camera through your scene, whether that scene is an interior or an exterior design. You can use the camera to explore your virtual conception, and see if you actually end up with what you thought you designed. You can also present your walkthroughs to your clients and colleagues.

There are a variety of methods you can use to create a walkthrough animation. In this chapter we’ll teach you a simple method of placing a camera on a path.



Skill level: Beginner

Time to complete: 1+ hours (includes rendering time to create an animation)

Features Covered in This Tutorial

In this tutorial, you will learn how to:

- Create Free and Target cameras.
- Adjust the animation length for a suitable camera motion.
- Apply a path constraint to a camera.
- Use Set Key to animate the camera target.

Tutorial Files

All the necessary files to do the tutorials can be found on the Tutorial, Samples, And Partners CD, in the `|tutorials|walkthrough` folder, unless otherwise specified.

Creating a Walkthrough

Set up the lesson:

- Open the `great_wall_head.max` file from the `|tutorials|walkthrough` folder.

Tip: If the Units Mismatch dialog displays, choose Adopt The File’s Unit Scale and then click OK.

Calculate the Required Number of Frames:

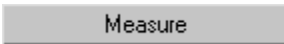
1. Press **H** to open the Select Objects dialog, and then double-click Camera Path.
2.  From the Utility panel, click the Measure tool. This tool reports the length of the camera path, which is approximately 900 feet.

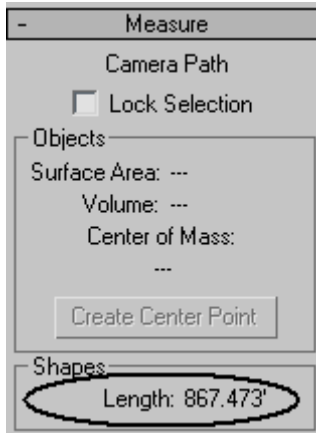

Note: For a comfortable walking pace in architectural walkthroughs you'll need about a second for every 3 feet of distance. For a jog or a fast run, you can go as far as 9 feet for a second. In NTSC format, that translates into 30 frames for every 9 feet of distance traveled, or 3000 frames for 900 feet.

3.  Click the Time configuration button next to the Current Frame Field.
4. In the Animation group in the Time Configuration dialog, change End Time to 3000 to increase the number of frames in the animation, and then click OK.

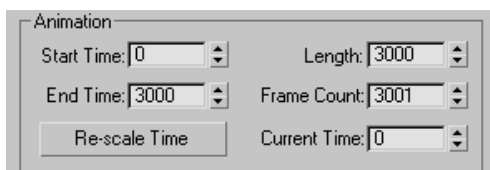

This will provide sufficient frames for your walkthrough animation.

The time slider frame indicator now displays 3000 frames.

Creating a Free Camera:

1. From the Cameras category of the create Panel, click the Free button.

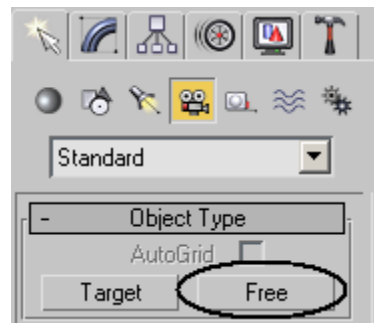

2. Click to create the camera anywhere within the Front viewport.
3. In the Name and Color rollout, rename the camera *FreeCam*

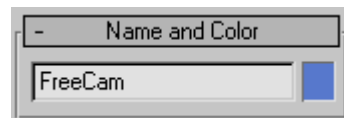

Assigning a Path Constraint to the Camera:

1. Press **H** to open the Select by Name dialog.
2. Double-click on FreeCam, the camera you just created.
3. From the Animation menu at the top of the screen, choose Constraints > Path Constraint. A rubber band appears.
4. Press **H** to access the Pick Object dialog, and then double-click Camera Path to select it. This places the camera on the path and gives the Motion panel focus. The selected path appears in the Target window of the Path Parameters rollout.

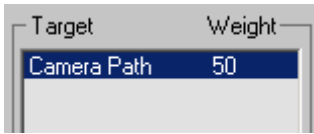

5. Enable the Follow option in the Path Parameters rollout.

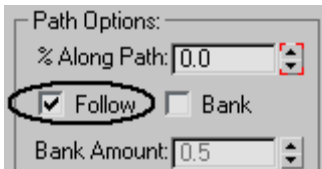

6. Set the Follow Axis to Y.

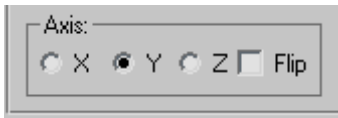

7. Right-click the Perspective viewport to activate it, and then press C to view what the camera is looking at.

8.  Click Play to view the animation.

The Free Camera travels along the path but the motion seems unnatural. At times it aims too high and at other times too low. The Free Camera direction is maintained tangential to the path. While the Free Camera may be suitable for a path constrained to a horizontal plane it isn't ideal for the undulating path in this scene. In the next section you'll try a Target Camera.

Creating a Target Camera:

A Target camera follows a path in the same fashion as a free camera. Instead of aiming tangential to the path it remains directed towards its target, which can be animated independently.

1. Stop the animation if it is still playing and go to Frame 0.

2. Select the FreeCam you created in the previous section if it is not already selected.
3. Right-click over the camera, and then, from the quad menu, select Hide Selection.

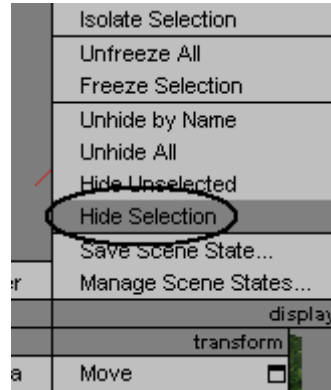

4. From the Cameras category of the Create Panel, click the Target button.

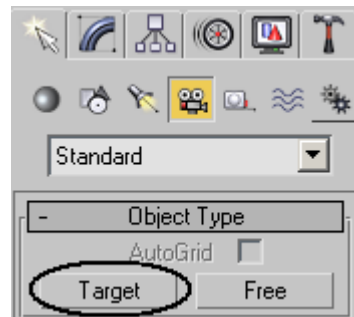

5. Click and drag to create the camera anywhere within the Top viewport.

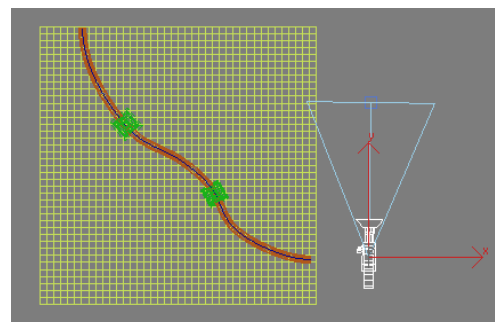

- In the Name and Color rollout, rename the camera *TargetCam*.

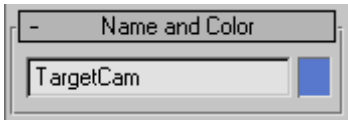



- Assign a Path Constraint, as you did earlier, to constrain the new camera to the existing path.
- Activate the FreeCam viewport.
- Press C to view the selected Camera's point of view.
-  Click Play to view the animation. The target remains stationary while the camera moves along the path.

Animating the Camera Target:

To create a walkthrough with a target camera, you have to animate the target moving ahead of the camera and stop occasionally on points of interest.

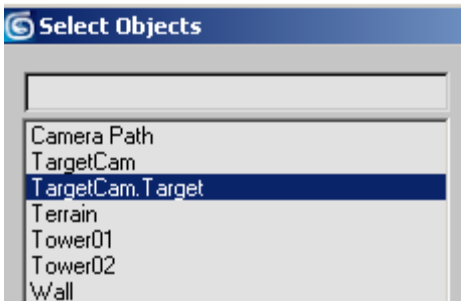
- Stop the animation if it is still playing and go to Frame 0.
- Press H to open the Select by Name dialog.
- Double-click TargetCam.Target.



-  Click and then right-click the move tool.
- At frame 0, position the target at -22, -200, 147.

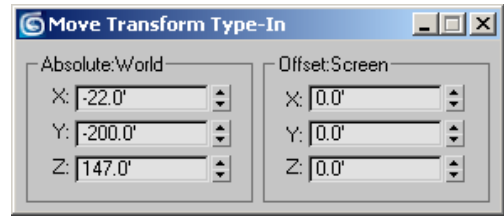

This gives an appropriate starting direction for the camera.

-  Press Auto Key.
- Move the time slider to frame 194.
- Position the target at 80,-69,26.

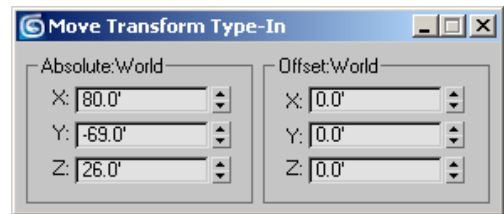

Note: From the Top viewport that this position corresponds to the first tower along the wall, which is a suitable point of interest.

- Press shift and drag the key you just created to approximately frame 815. This holds the target at the tower as the camera approaches it.
- Move the time slider to frame 1050.
- Position the Target at 44,11,42.

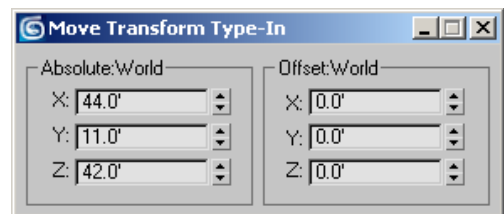

- Move the time slider to frame 1272.
- Position the Target at -141,112,92.

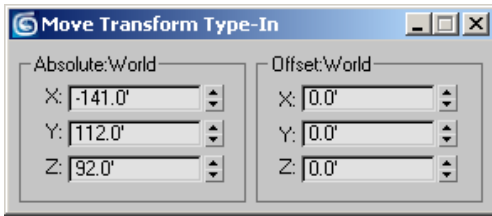

This positions the target near the second tower.

14. Press Shift and drag the key you just created to approximately frame 1820. This holds the target at the second tower while the camera approaches it.
15. Move the time slider to frame 1964.
16. Position the target at $-235, 250, 82$.

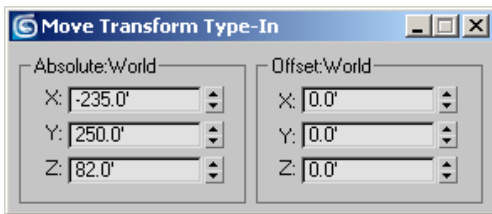

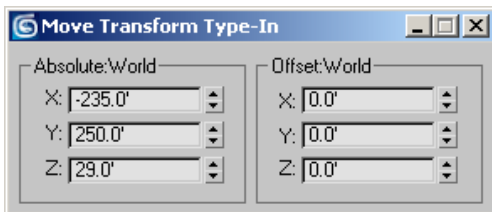

17. Move the time slider to frame 2135.
18. Position the target at $-235, 250, 29$.

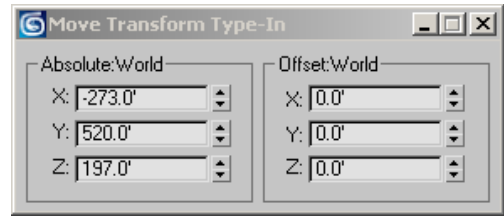

This lowers the target's position along the Z axis to accommodate the drop in the path just after the second tower.

19. Move the time slider to frame 2534.
20. Position the target at $-273, 520, 197$.



21. Press shift and drag the key you just created to approximately frame 2963.
22.  Click Play to view the result in the TargetCam viewport. Note how the target moves ahead of the camera to the points of interest along the way.
23. Turn off Auto Key mode.
24. Right-Click in the Top viewport to make it active.
25.  Click Play. Viewing the animation in the top viewport further emphasizes how the target is moving to the points of interest ahead of the camera.

Summary

In this lesson, you have created a camera walkthrough animation by calculating the number of frames needed for the animation, and you have learned to automate the creation of the camera and how to constrain it to a path. Finally, you have learned how to manually animate the head turn and tilt of the camera by animating the camera target to create realistic camera motion.

Biped Animation

Biped Quickstart

Quick Start

This tutorial introduces you to the elements of the built-in character animation features in 3ds Max and the workflow for some of its most important features.

Note: The components that are described in the following topics were previously offered separately in the **character studio** product, but are now integrated within 3ds Max 8.



The purpose of this tutorial is to familiarize you with:

- Creating and posing a biped
- Associating the biped with a mesh using the Physique modifier
- Animating the biped using two different methods, freeform and footstep animation
- Combining motions in the Motion Mixer

Skill level: Beginner

Time to complete: 1 hour

You can find the files for this tutorial in the *tutorials\character_animation\quick_start* folder on the Tutorial Files CD that ships with 3ds Max.



Creating a Biped

In this lesson, you'll create a default biped: a simple skeleton consisting of bones connected in a hierarchy. A default biped is different from 3ds Max Bone system objects because the biped structure automatically has built-in joints like a human being. You can bend your knee so your foot touches the back of your thigh, but you can't bend it forward so that your toe touches the front of your thigh. Biped creates skeletons in the same fashion. They are ready to animate, and work accurately without additional set up.

Set up the lesson:

- Reset 3ds Max.

Create a biped:

1.  On the Create panel, click Systems.
2.  On the Object Type rollout, click Biped.
The Biped button turns gold.
3. If you can't see the Height spinner in the Create Biped rollout, scroll to the bottom of the command panel.
4. In the Perspective viewport, place your cursor over the center of the grid, press down on the left mouse button, and drag upward.
A biped appears and grows with your cursor movement.
5. Drag upward until the Height spinner on the Create Biped rollout reads approximately 70 units, then release the mouse button.

A biped is created in the viewport.

The biped is a hierarchy of special objects. Its parent object (*Bip01*) is its center of mass (COM). The COM is displayed in the viewports as a small, blue tetrahedron, initially centered in the biped's pelvis. After you create a biped,

only the center of mass object is selected (not the entire biped).

Name the biped:

When you create your first biped, it has a root name of *Bip01*. The root name of each additional biped is incremented, so the next biped you create has a root name of *Bip02*. The root name acts as a prefix for each part of the biped, to make it unique from any other bipeds in the scene.

1. In the Create Biped rollout, highlight the current root name entry, *Bip01*, in the Root Name field.

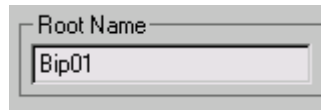

Note: You can also change the biped root name from the Motion Panel if you expand the Biped rollout.

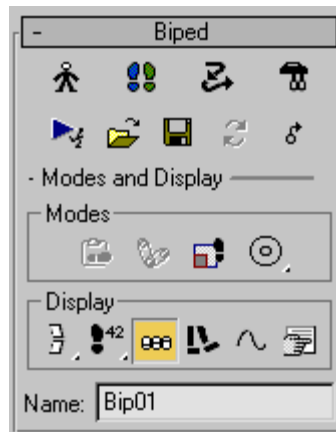

2. Enter the new root name, **MyBiped**.

Renaming the biped's root name to the name of the character is common practice and helps with scene organization.

3. Using File > Save As on the menu bar, save the scene as **MyBiped.max**.

To find more information about building bipeds, see the tutorial *Working with Biped Parts* (page 1–383).

Posing a Biped

Once you've created a biped, you need to pose it to match the character model that the biped will control. This is done in Figure mode, which allows you to bend, rotate, and scale parts of the biped to conform to the character mesh. In this lesson, you will adjust a biped to fit a character mesh.

Character meshes are usually built in one of two stances. The most common is with the arms out and the legs slightly spread, like da Vinci's drawing of the Vitruvian Man. Or, the character mesh is built in a resting position with arms at its sides and legs together.

For this lesson, you'll be working with a character named Dr. X.

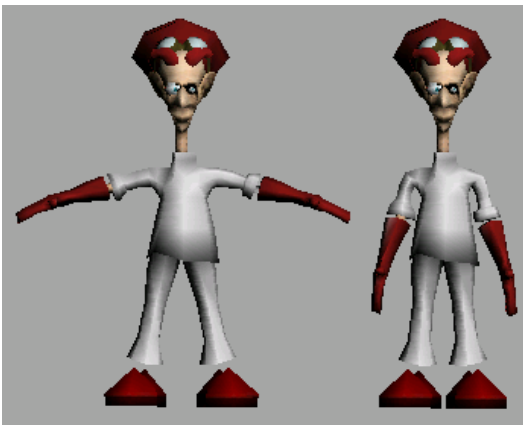

Left: Dr. X exhibiting the Vitruvian Man stance; right: a resting position.



Set up the lesson:

1. Reset 3ds Max.
2. Load the scene file *cs4_qs_drX01.max* from the *tutorials\character_animation\quick_start* folder.

This scene contains a character mesh named *DoctorX*.

Build the biped:

Now that you know how to create a biped, you're going to use the character mesh as a template for building the biped that will control Dr. X.

1.  On the Create panel, click Systems.
2.  Turn on Biped and make sure you can see the Height spinner in the Create Biped rollout.
3. In the Front viewport, click down at Dr. X's feet and drag up until the biped is about 1.0m in height

This will place the center of mass (COM) roughly at Dr. X's pelvis.

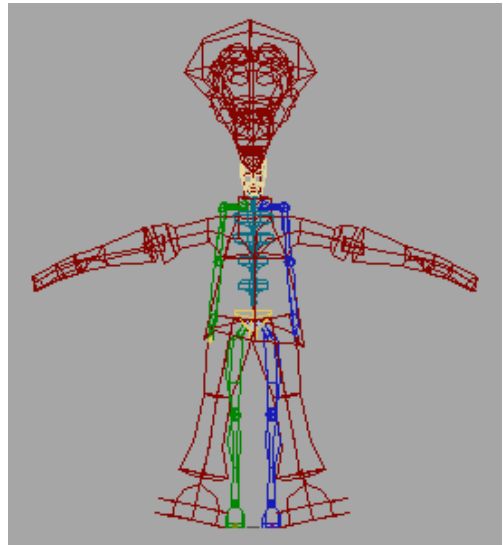



The new biped and Dr. X.

4. In the Create Biped rollout, change the Root Name to **Dr.X**.

Position the biped:

Once the biped is added to the character mesh, you need to adjust the biped to better match the stance of the mesh. First, you'll adjust the position of the biped within the Dr. X model.

1.  Click the Motion panel tab.
2.  In the Biped rollout, turn on Figure Mode.

All changes to the biped's reference pose must be done in Figure mode.

3.  In the Left and Front viewports, click Zoom Region and zoom in around the pelvis of Dr. X.

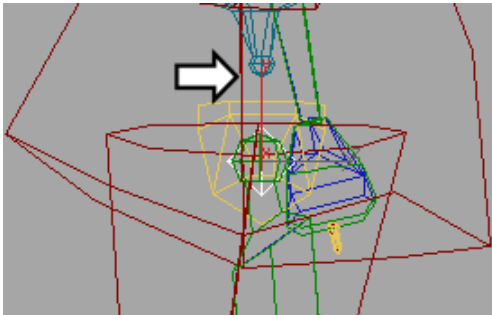

The illustrations show the COM in white and arrows pointing at the center line of the mesh.



Zoom into Left viewport



Zoom into Front viewport

4.  In the Track Selection Rollout, make sure the Body Horizontal button is active.
5.  Move *Dr.X*, the COM, in both the Left and Front viewports so that it lines up with the vertical center line of the character mesh.

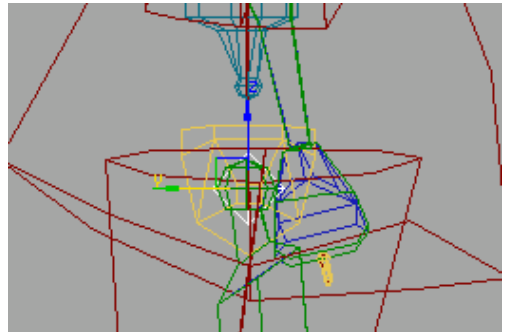

Bip01 moved in the Left viewport



Bip01 moved in the Front viewport

Adjust the legs:

Next, you'll adjust the legs so they conform with the character's legs. When adjusting legs, you'll want to pay close attention to the key bend points at the knees and ankles.

1.  Activate the Front viewport. Enlarge the viewport by pressing **ALT+W** on the keyboard and click the Zoom Extents button.

2.  Select the biped's left thigh, *Dr.X L Thigh*. This is colored blue by default, and its name appears in the name field at the top of the Motion panel when selected.



Tip: If you select the mesh by mistake, deselect by clicking outside the figures, and then try again.

3.  From the Track Selection rollout, click the Symmetrical button.

The biped's right thigh, *Dr.X R Thigh* is now added to the selection set.

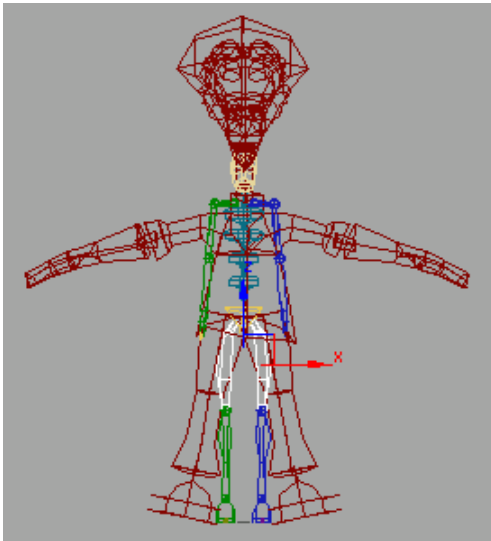

4. In this step, you rotate the biped's legs to run roughly along the legs of the mesh. To make these rotations, you'll have to switch between the Front and Left viewports. Press **F** and **L** on the keyboard to make these switches.



Click the Rotate button and make the following rotations:

- In the Front viewport, rotate about **12.0** degrees about the Z-axis. A readout appears in yellow as you rotate the selection.

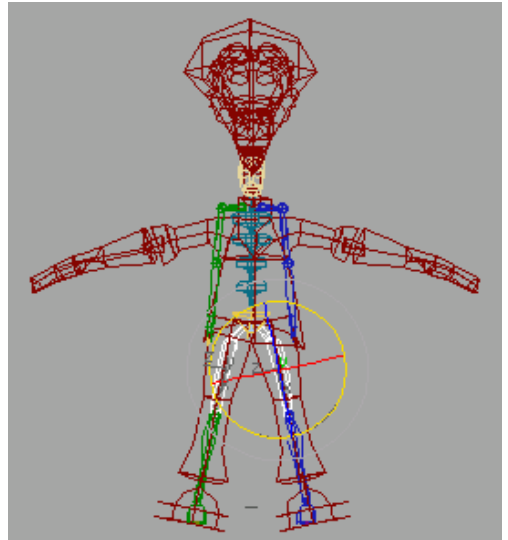

- In the Left viewport, rotate about **-8** degrees about the Z-axis.

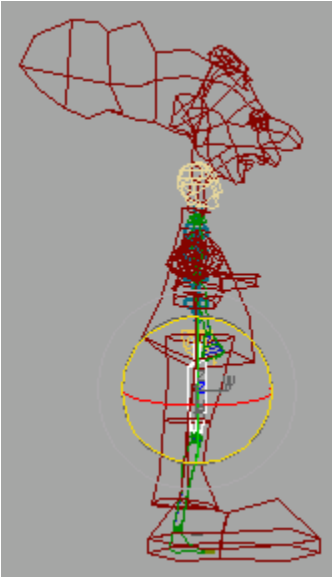

- TIP: You can type in the rotation values if you right-click and choose the Rotate Settings button from the quad menu.
5. Right-click and from the Quad menu, choose the Scale settings button. Scale the thighs along the X-axis by 85%. Type in the value or use the spinners while viewing the results in the viewport.

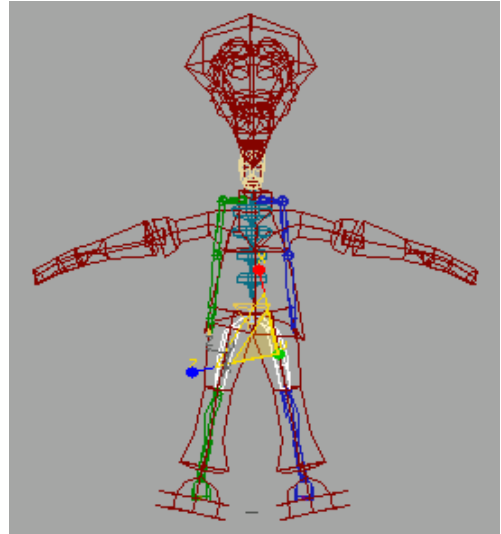

6. Press the Page Down key on the keyboard. Page Up and Page Down are quick shortcuts for moving up and down the hierarchy. Since both thighs were selected, now both calves are selected once you've pressed Page Down.
7.  Scale the calves by about 90% along the X-axis as you did with the thighs earlier. This aligns the biped's ankles more closely with the ankles of the character mesh.

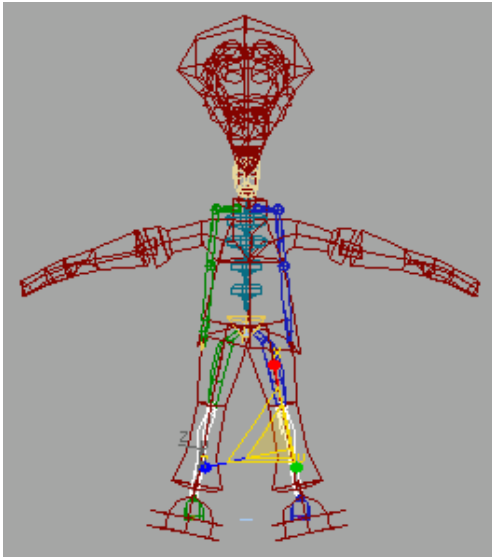

The Left view of the scaled thighs and calves.

8. Page Down again to select the biped foot objects. Scale the feet from the Front and Left views to more closely fit in the shoes.

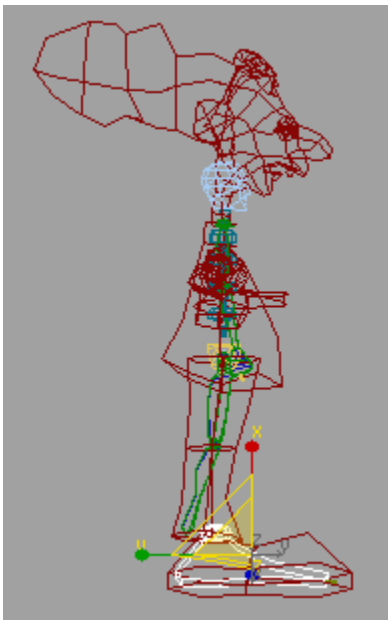

9. On the Structure rollout, adjust the Ankle attach value to slide the foot to better fit in the mesh.

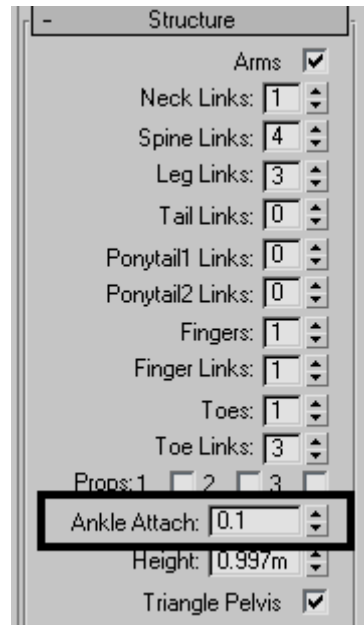

10. In the Front viewport, rotate the Bip Foot objects so they match the mesh angle.

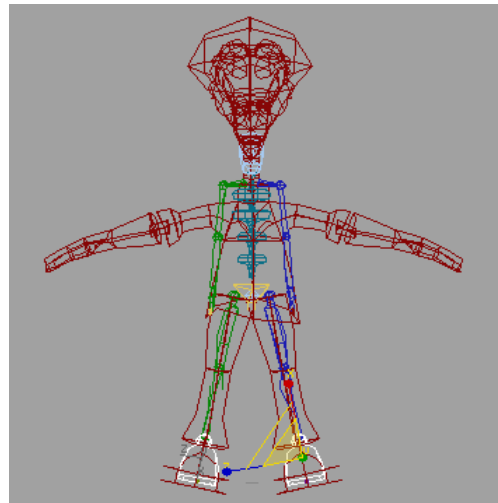

Rotate the feet to fit the mesh.

11. Save the scene as **my_drx01.max**.

The procedures you've just completed give you an idea of what it takes to align a biped to a mesh, and that patience is the key to this process. This character still needs work, such as the feet need to be adjusted as well as the entire upper body. If you want, read the following tips for biped alignment, then use the same procedures to experiment with aligning the rest of the biped. Otherwise, continue to the next lesson.

Tips for Biped Alignment

Here are some tips that may help when adding a biped to a character mesh.

- The most important tip is to make sure the COM is always aligned with the mesh.
- When scaling and rotating biped parts, pay attention to the model in multiple viewports. A rotation, for instance, may look good in one viewport, but another viewport may indicate a problem.
- Examine the character mesh's complexity. If the character is wearing mittens or shoes, you probably don't need five fingers and toes. Adjust the biped structure accordingly.
- Remember ponytails. If the character has a lot of hair or a long nose, like an elephant trunk, you can use a ponytail to control that part of the mesh.
- If the character mesh has a short torso or long neck, it may be best to reduce the number of Spine Links or increase the number of Neck Links. You can add up to 25 links in the neck, tail or ponytails, and up to ten links in the spine.
- If the character is carrying something like a weapon or tool, add a Prop to control that object.

For a more detailed look at posing a biped, see the lesson *Aligning the Biped to the Model* (page 1–386).

Applying Physique

After the biped is posed to match the character mesh, you apply the Physique modifier to the character mesh. The Physique modifier associates the biped with the character mesh.

After Physique is applied and set up, any animation on the biped is passed on to the mesh, making it move as if there were bones and muscles underneath.

Set up the lesson:

1. Load *cs4_qs_drX02.max* from the *tutorials\character_animation\quick_start* folder.
This scene contains Dr. X and a completely posed biped.
2. In the Front viewport, zoom in on the biped's pelvis (orange triangle) and the center of mass, or COM (blue tetrahedron).

Apply Physique:

1. Select the character mesh, *DoctorX*.



2. On the Modify panel, choose Physique from the Modifier List.

The Physique rollouts appear in the command panel.



3. In the Physique rollout, click Attach To Node, then click the biped's COM.

The Physique Initialization dialog displays.

4. Click Initialize.

The character mesh is now associated with the biped. The orange deformation spline running through the mesh indicates that the entire biped structure has been associated with the mesh.

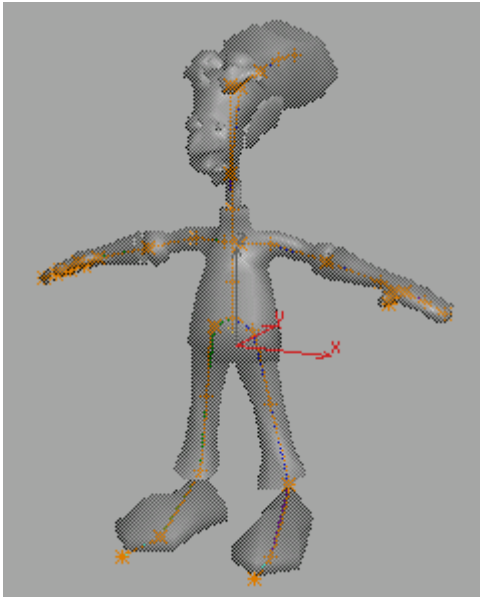

Orange spline follows Dr. X mesh. (This view uses See-Through display mode with the biped bones hidden.)

Tip: To toggle the view to See-Through display mode, select the DoctorX mesh and press ALT-X.

Adjust the envelopes:

Physique associates the biped with the mesh via the mesh's vertices. Each biped part is surrounded by an area called an *envelope*, and mesh vertices that lie inside an envelope are effected by that biped part. The default size of an envelope depends on the size of the biped part, which you set when you pose the biped.

Often, envelopes need to be manually adjusted to make the biped work properly with the mesh. If you notice irregular spikes poking out from the mesh, it's a good indication that one or more vertices lie outside of an envelope's area of influence. You can see this effect by rotating the arm.

1.  Right-click in the Top viewport to activate it and use Region Zoom to view Dr. X's left arm.

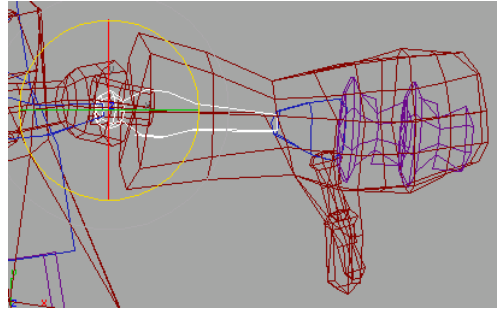

2.  Select *DrX Biped L Forearm* and rotate it up and down. You'll see some vertices don't move with the arm.



Vertices that are not influenced by the envelope pull out of shape.

3. Press **CTRL+Z** to put the arm back to its original position so you can adjust the envelope.
4. Select the *DoctorX* mesh again and in the modifier stack, click the plus (+) symbol next to Physique and highlight the Envelope sub-object.

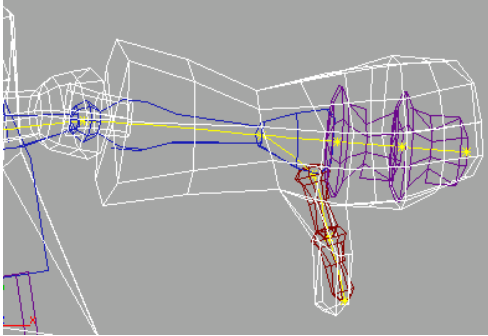

Note that the orange splines running through the biped have turned yellow. These are deformation splines, which deform the mesh as the spline moves.

5. Select the deformation spline running along the biped's left forearm to display the associated envelopes.

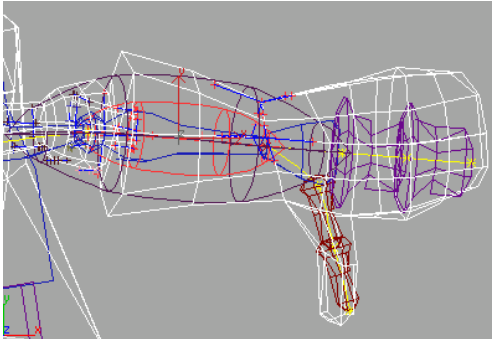

Notice that each biped part has two envelopes, an inner one (red) and an outer one (purple). Some of the vertices near the opening of the glove are outside the outer envelope boundary. These vertices won't be affected at all by the biped's lower arm unless the envelope is enlarged.

6. In the Blending Envelopes rollout, in the Envelope Parameters group, increase the Radial Scale parameter to **2.0**.

The vertices at the opening of Dr. X's glove are now within the envelope.

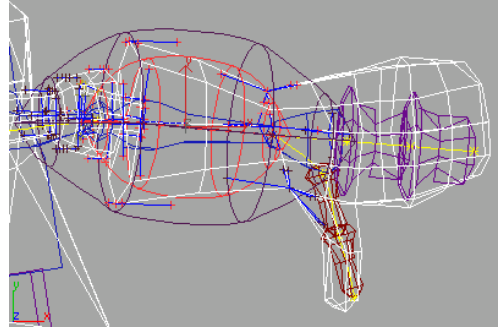

The dark outer envelope completely encompasses the lower arm.

Many more small adjustments are needed to make all the envelopes fit the mesh correctly. In the next lesson, you'll load a file that has a mesh with envelopes that are properly adjusted.

Note: Keep in mind that the default envelopes are based on the size of the biped bones. Therefore, if you adjust the envelopes of a character that uses the Classic biped body type, and later change to the Skeleton body type, the envelopes are going to be much smaller and will require more editing.

When you have finished adjusting envelopes, you can apply a MeshSmooth modifier to the mesh above the Physique modifier to make the mesh look smoother.

7. Apply the MeshSmooth modifier to the mesh above the Physique modifier, and set Iterations to **1**.

When MeshSmooth is placed above Physique on the stack, you only need to adjust envelopes for the low-poly version of the model. The Physique settings are passed up the stack to the MeshSmooth modifier.

8. Save your work as **my_drx02.max**.

If you want to learn more about adjusting envelopes and vertex assignments, see the lesson *Adjusting Envelopes* (page 1–400).

Animating the Biped with Freeform Animation

There are two types of animation that a biped can perform: Freeform animation and Footstep animation. In this lesson, you'll use Freeform animation to make Dr. X do a series of deep knee bends. Freeform animation does not use footsteps. You manually set all the keys in a Freeform animation.

To get an idea of how your animation should turn out, view the preview file, *drxkneebends.avi*, in the *tutorials\character_animation\quick_start* folder.



Dr. X doing his deep knee bend exercises

Set up for this lesson:

1. Open *cs4_qs_drx03.max* from the *tutorials\character_animation\quick_start* folder.



This scene contains Dr. X with properly adjusted envelopes.



2. Press the **H** key and choose *DrX Biped L Foot* from the Select Object list, then click the Select button.

Plant the feet:

Since Dr. X is doing squats, his feet are not required to move. You'll plant his feet to keep them from moving throughout the exercise.

1.  Open the Motion panel.
2. Expand the Key Info rollout, and expand the IK expansion bar.
The left foot is selected, so you can set a key for it.
3.  In the Key Info rollout, click Set Planted Key.
4. In the Track Selection rollout, click the Opposite button to select DrX Biped R Foot.
5.  Click Set Planted Key to set a key for the right foot.

Animate the first knee bend:

You'll start by animating the knee-bending motion. Dr. X will start the knee bend in his current stance with arms outstretched, and perform a total of

four squats. When completed, he'll return to his original stance.

When the feet are planted, you animate the knees bending by moving the biped's center of mass up and down.

1. Make sure the time slider is at frame 0.

2.  In the Track Selection rollout, click Body Vertical.

This selects the center of mass's body vertical track.

3.  Turn on Auto Key.
4. Move the center of mass (COM) downward slightly to make the character's knees bend a little bit.



This places a key for the center of mass's body vertical track at frame 0.

5. Right-click in the Front viewport to activate it, and move the time slider to frame 15.

6.  Move the COM down about -0.25m on the Z-axis.

Watch the Coordinate display Z-field until it reaches about -0.25m and release the mouse

button. A key is automatically created at frame 15. This is Dr. X's squatted pose.



7. Scrub (pull) the time slider to see Dr. X bend his knees once.

Copy and paste the standing posture:

1. Move the time slider to frame 0.
2. Expand the Copy/Paste rollout.

The tools on this rollout enable you to quickly copy and paste keys from one frame to other frames. By default, the Posture option is selected. This option pastes keys from individual body parts.

3. In the Copy/Paste rollout, click Create Collections. Name the Collection Dr X poses.

4.  Click the Copy Posture button.

5. In the Copied Postures field, rename the posture to the name **Standing**.

6. Move the time slider to frame 30.

7.  Make sure Auto Key is still turned on.

8.  In the Copy/Paste rollout, paste options group, click the Paste Vertical button.

9.  Click Paste Posture.

Dr. X stands up again. When you paste a posture with Auto Key turned on, a key is created at the current frame with the new posture. Here, a new key was created for the COM's Body Vertical track at frame 30.

Copy and paste the squatting posture:

1. Go to frame 15.

2.  In the Copy/Paste rollout, click the Copy Posture button. Rename the posture to **Squatting**.

3.  Go to frame 45, and click Paste Posture.

Paste the remaining postures:

Now that you've stored the two postures, you can easily paste them to other frames.

1. Go to frame 60. Choose the *Standing* posture from the Copied Postures list, and click Paste Posture.
2. Go to frame 75. Choose the *Squatting* posture from the Copied Postures list, and click Paste Posture.
3. On frame 90, paste the *Standing* posture.
4. On frame 105, paste the *Squatting* posture.
5. On frame 120, paste the *Standing* posture.

You have now created all the knee-bend motions for this animation. If you like, you can play the animation to see the motion.

6. Save the scene as **MyDrX02.max**.

Animate the arms:

Now that the legs are set to bend, you'll rotate the arms and lock the upper body. As Dr. X dips

down, his arms are going to swing forward, then back out to his sides as he rises. You'll also set two keys to lock the upper body to keep Dr. X facing forward.

1. Press the **H** key and choose *DrX Biped L UpperArm*, then click the Select button.

2.  From the Track Selection rollout, click the Symmetrical button to select the opposite upper arm.

3. Move the time slider to frame 0.

4.  On the Key Info rollout, click Set Key.

This sets a key for the arms in their outstretched position.

Warning: Be sure to use the Set Key button on the Key Info rollout, not the Set Key text button under Auto Key.

5.  On the Copy/Paste rollout, click Copy Posture. Name the posture **Arms Out**.

6. Move the time slider to frame 15.

7.  In the Top viewport, rotate the arms about -75 degrees around the Z-axis.

Look at the Z-field in the Coordinate display Z-field when rotating the arms. A key is added, and Dr. X's arms are in the forward position.



8. On the Copy/Paste rollout, click Copy Posture, and name the posture **Arms Forward**.
9. Paste the copied postures to set keys for the arms on these frames:
 - Frame 30: Arms Out
 - Frame 45: Arms Forward
 - Frame 60: Arms Out
 - Frame 75: Arms Forward
 - Frame 90: Arms Out
 - Frame 105: Arms Forward
 - Frame 120: Arms Out

Save a motion clip:

When you're happy with the results of the animation, you want to save it so the motion can be reused in the future. When you save a motion, it is saved in the *.bip* file format, the native format for biped character movement.

1. Select any part of the biped. If you have hidden the biped to render the scene, you must unhide it before you can select it.



2. From the Biped rollout, choose Save File. The Save File dialog displays.
3. Specify a folder where you are storing your motion files such as a new *tutorials\character_animation\motions* folder.
4. Enter **my_kneebends** as the file name and click Save.

The motion is saved as a BIP file.

To learn more about freeform animation, see the tutorial *Animating with Freeform* (page 1-343).

Play the animation:

1. Select all the parts of the biped, and right-click and choose Hide Selection.
2. Select the mesh. In the Modify panel, turn on the MeshSmooth modifier by clicking the light bulb to turn it on.
3. Play the animation.
4. Save the scene as **my_drx03_freeform.max**.

Animating the Biped with Footsteps

Now that you're familiar with freeform animation, you'll learn the basics of footstep animation. Footstep animation only controls the placement of the biped's feet. In this lesson, you'll create a footstep animation where Dr. X walks for eight steps.

You can see what your animation should look like by viewing the preview file, *drxwalk.avi*, in the *tutorials\character_animation\quick_start* folder.



Set up the lesson:

1. Reload *cs4_qs_drX03.max* from the *tutorials\character_animation\quick_start* folder.

This scene contains Dr. X with Physique applied to the mesh, and all envelopes adjusted. The mesh is ready for animation.



2. Press the **H** key and choose *DoctorX* from the Select Object list, then click the Select button.

3. In the Perspective viewport, right-click the mesh and choose Hide Selection from the quad menu.

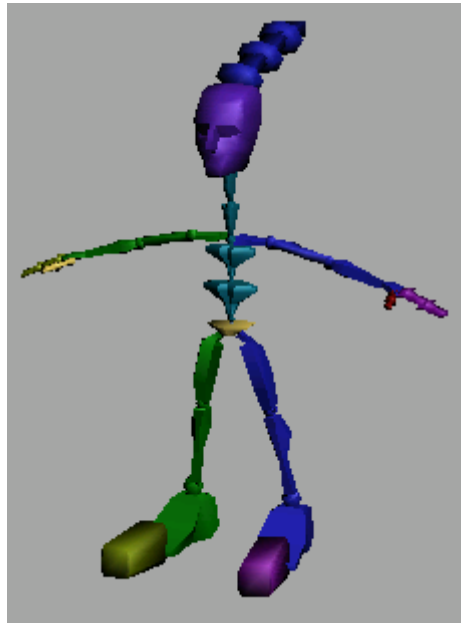

Hiding the mesh makes it easier to select the biped and test the animation. This is especially true if you have a highly detailed mesh.



4. Press the **H** key again and choose *DrX Biped*, the center of mass, from the Select Object list, then click the Select button.

Create the footsteps:

Now you'll make Dr. X walk forward in a straight line.

1.  Open the Motion panel.
2.  In the Biped rollout, turn on Footstep Mode.

Using the rollouts that now display, you'll create footsteps for Dr. X.

3.  In the Footstep Creation rollout, click the Create Multiple Footsteps button.

The Create Multiple Footsteps: Walk dialog displays.

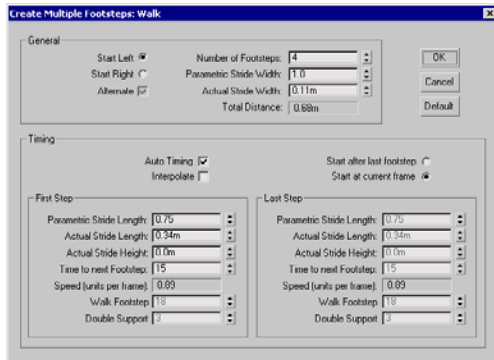

4. In the General group, increase the Number Of Footsteps to 8 and click OK.

5.  In the Footstep Operations rollout, click Create Keys For Inactive Footsteps.

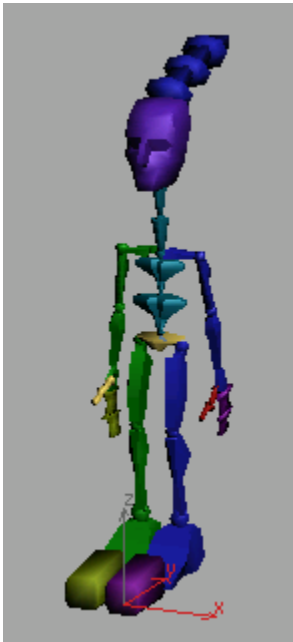

When the footstep keys are created, Dr. X changes his pose.

6.  Right-click in the Perspective viewport, and then click the Play Animation button. You can also scrub the time slider to examine the animation more closely.

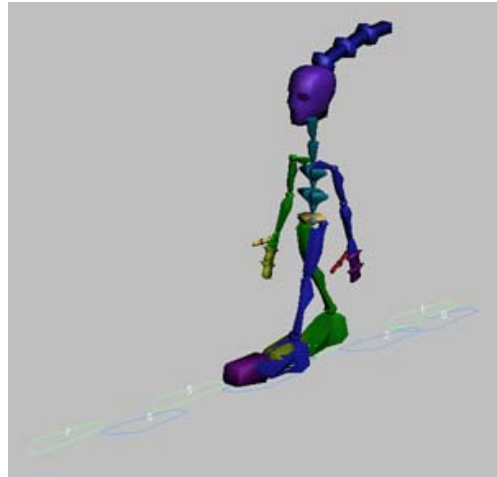

By just watching the biped walk, you can tell that Dr. X's walk doesn't look right. You can see that the feet are too close together, and his arms are straight down at his side. In addition, the shoes and hands will collide or intersect with other body parts when the mesh is displayed again. Next, you'll do some fine tuning to make Dr. X's walk look better.

Fine tune the animation:

In this part of the lesson, you'll make a few adjustments to clean up the animation.

1. If you don't see footsteps outlined in front of Dr. X, do the following:
 - In the Biped rollout, click the gray expansion bar below the buttons. Additional buttons appear.

-  In the Display group, click the Show Footsteps And Numbers button.



Note: If the footsteps still fail to display, click the Show Footsteps And Numbers button and hold until you see the button flyout. Choose the Show Footsteps And Numbers button from the flyout.

- In the Perspective viewport, zoom out, if necessary, to see all the footsteps. Drag a selection window around all the footsteps. Be sure to include the two footsteps under the biped's feet.

The footsteps turn white after they're selected.

Note: Because you're working in Footstep mode, only the footsteps can be selected, so you can drag over the biped without fear of selecting other objects.

- In the Footstep Operations rollout, turn off Length and increase the Scale to 2.5.

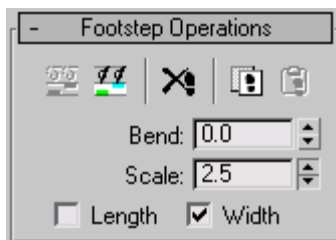

The biped's stance widens to more closely match how it looked in Figure mode. However, now that the stance is wider, the hands will intersect the legs when the mesh is unhidden. You'll fix that next.

Rotate the arms:

With the wider stance, the hands intersect the legs as they swing past. Now you'll do a little freeform animation to give the arms some clearance.

-  In the Biped rollout, turn off Footstep mode.

Now you can rotate Dr. X's arms.

- Press the **H** key and select *DrX Biped L Upperarm*.

-  In the Track Selection rollout, click the Symmetrical button.

Notice the keys in the time line. At each of the keys, you'll rotate the arms.

-  Turn on Auto Key and Key Mode Toggle, then click the right arrow on the time slider.

The time slider jumps to frame 30.

-  On the Main toolbar, click the Rotate button.

- On the Coordinate display, in the Y-field, enter 12.

The arms are rotated out away from the body.



7. Continue clicking the right arrow on the time slider to jump to the next key and repeat the same amount of rotation for each key on the time line.

Don't forget the key at frame 0.

8. **Auto Key** Turn off Auto Key to end the animation process.
9. Play the animation.

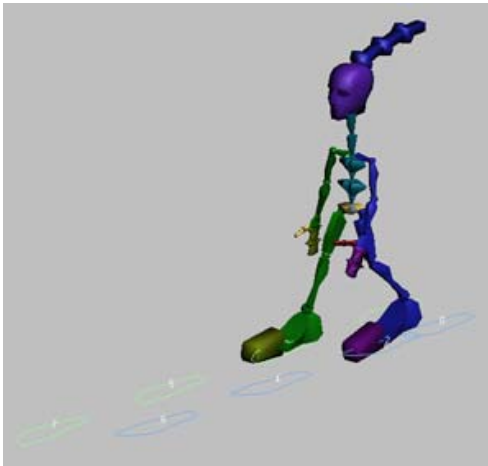

Save the motion in a BIP file:

You can save the footstep motion for later use in other scenes.

1.  From the Biped rollout, choose Save File. The Save File dialog displays.
2. Specify a folder where you are storing your motion files such as a new *tutorials\character_animation\motions* folder.
3. Enter **my_DrXWalk** as the file name, and click Save.

The footstep motion is saved in the BIP file.

Prepare for playing or rendering:

1. Press the **H** key and click the All button, then click Select.
2. Right-click the biped and choose Hide Selection. The biped is now hidden.
3. Open the Display panel. In the Hide rollout, click Unhide By Name. The Unhide Objects dialog displays.
4. Select *DoctorX* from the list and click Unhide. Dr. X's mesh is unhidden.
5. On the Modify panel, turn on the MeshSmooth modifier by clicking the light bulb to turn it on.
6.  Click in the Perspective viewport and click the Play Animation button.



7. Save the scene as **my_drX03_footsteps.max**.

You can find a finished version of this scene in the file *cs4_qs_drX03_footsteps.max*.

Combining Motions with the Motion Mixer

In this lesson, you'll use the Motion Mixer with the two motion files you've just created. The Motion Mixer lets you create a smooth transition between Dr. X doing his deep knee bends and walking.

Set up for this lesson:

- Open the file *cs4_qs_drX03.max* from the *tutorials\character_animation\quick_start* folder.

This scene contains Dr. X ready for animation.



Open the Motion Mixer:

The Motion Mixer is similar to a sound mixer, except you'll work with animation files instead of audio files. You'll add motion clips, which are *.bip* files, to the Motion Mixer, and create transitions between the clips to smoothly blend them together.

1. Select any part of the biped.



2. Open the Motion panel.



3. On the Biped rollout, turn off Figure Mode.



4. In the Biped Apps rollout, click the Mixer button.

The Motion Mixer window opens.

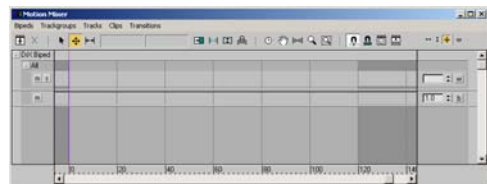

The biped is automatically displayed in the Mixer. It has a default *trackgroup* labelled All, where you will start laying out your tracks, motion clips, and transitions. The label All

indicates that motions placed on tracks will apply to the entire biped, rather than specific body parts.

Tip: The Motion Mixer window can be resized. For better viewing of what's added to the Mixer, you can drag the edge of the window vertically and horizontally.



Opening the Motion Mixer also automatically turns on the Mixer Mode button on the Biped rollout. When Mixer mode is on, the biped performs the motions in the Motion Mixer.

Add the clips to the Mixer:

Trackgroups are populated by *tracks*, in the form of Layer tracks or Transition tracks. On each track, you add *clips* and *transitions*. The final product of your efforts is called a *mix*.

Here, you'll add two clips to the trackgroup with a transition between them.

1. Click in the topmost track on the All trackgroup to select it. The track turns a lighter gray color when selected.

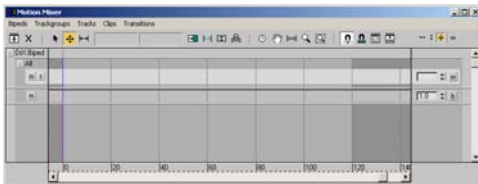

By default, the topmost track is a *layer* track, which is designed for consecutive clips with no transitions between them. You want to create a transition between two clips, so you'll need a *transition* track.

2. On the Mixer menu bar, open the Tracks menu and choose Convert To Transition Track.

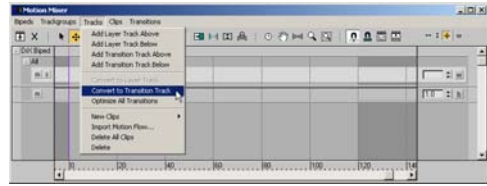

The track is changed to a transition track that is taller than the original, with room for two tracks and a transition.

Tip: You can right-click the track to access the same menu options.

3. On the Tracks menu, choose New Clips > From Files.



The Open dialog displays.

4. If you've done the two previous lessons and want to use the motions you created, browse to the folder where you saved your motions, and choose *my_kneebends.bip*. Otherwise, browse to the *tutorials\character_animation\quick_start* folder and choose *kneebends.bip*.

The clip holding the knee-bend motion is added to the track.

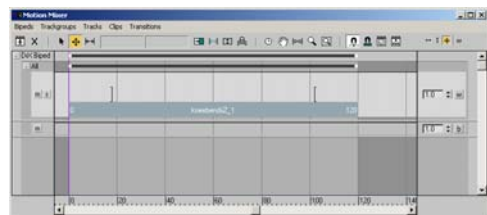

The clip appears with hatchmarks, indicating that it is not yet valid. A clip on a transition

track has to have a transition to be valid. You'll take care of this in the next step.

Note: The color of the clip in your Motion Mixer might differ from the color of the clip in the image.

- Right-click a blank area of the transition track, and choose **New Clips > From Files** from the pop-up menu. Choose the file *my_drxwalk.bip* or *drxwalk.bip*.

The second clip is added to the track, and a transition is automatically added between the two clips. The transition is colored with a darker version of the clip color, and spans the transition time between the two clips.

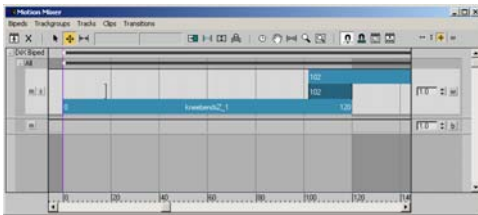

- On the Motion Mixer toolbar, click **Zoom Extents** so you can see the entire mix in the display.

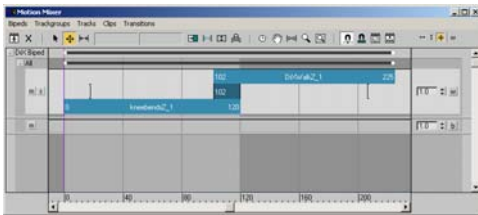

- On the Motion Mixer toolbar, click **Set Range**.

This feature automatically sets the length of the animation to the number of frames needed for the mix. In this case, it sets the animation length to 225 frames.

Play the mix:

You've just created a basic mix comprised of two clips and a transition. Now you'll play the animation.

- In the Biped rollout, turn on the **Mixer Mode** button if it's not already active.
- Click the **Play Animation** button on the 3ds Max status bar. Watch the animation in the viewport and its progress in the Mixer window.

Dr. X does his knee bends in the first clip.



He smoothly transitions to walking in the second clip.



The feet slide a little during the transition, but this problem can be fixed with the Mixer. For information on how to do this, and for a more detailed look at other features in the Motion Mixer, see the tutorial *Mixing Animation* (page 2-547).

3. Save the scene as **my_drx03_mixer.max**.

You can find a finished version of this scene in the file *cs4_qs_drx03_mixer.max*.

Tip: If you want to render this animation, hide the biped, select the mesh, and turn on the MeshSmooth modifier on the Modify panel before rendering.

Animating with Footsteps

Footstep mode uses a unique footstep gizmo to control the contact of the foot with the ground. When you move a footstep gizmo to a new

location, the animation updates to match the move.

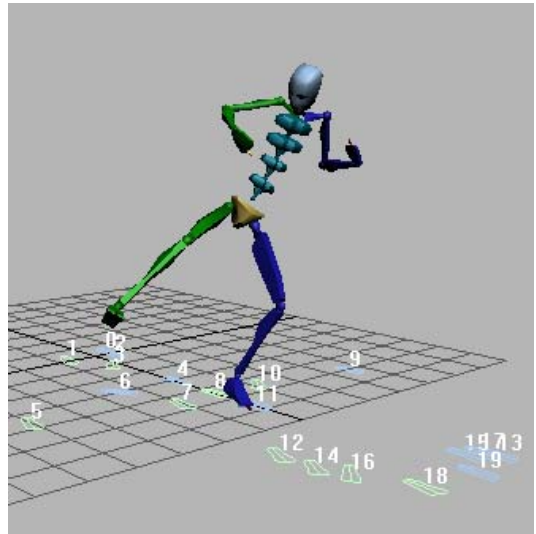

Footstep animation

In this tutorial, you'll do the following:

- Animate a biped using footsteps.
- Make a biped walk, run, jump, and do flips.
- Make a biped take a pratfall.
- Add a freeform period to a footstep animation.
- Convert a footstep animation to freeform.
- Change the duration of a footstep animation using IK keys.

Skill level: Beginner

Time to complete: 1+ hours

You can find the files for this tutorial in the *tutorials\character_animation\footstep_animation* folder on the Tutorial Files CD that ships with 3ds Max. Before starting the tutorials, copy the *tutorials* folder from the CD to your *3dsmax8* local installation.

Creating a Distinctive Walk

In this lesson, using automatically created motion as the basis, you'll animate a biped walking with a rolling, springy step.

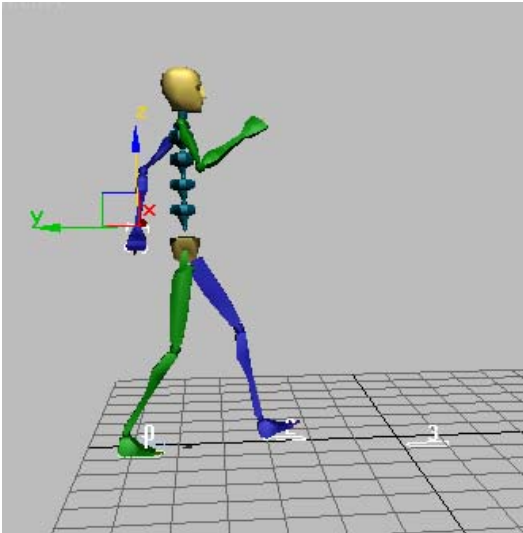

The automatic footsteps generate a starting point for you. You'll then change the automatic walk into something more expressive and distinctive. This sophisticated yet simple approach results in a natural-looking motion that you can create quickly.

Set up for this lesson:

1. Reset 3ds Max.
2. From the *tutorials\character_animation\footstep_animation* folder, open *walk_start.max*.

In this file, a biped is standing near the origin.

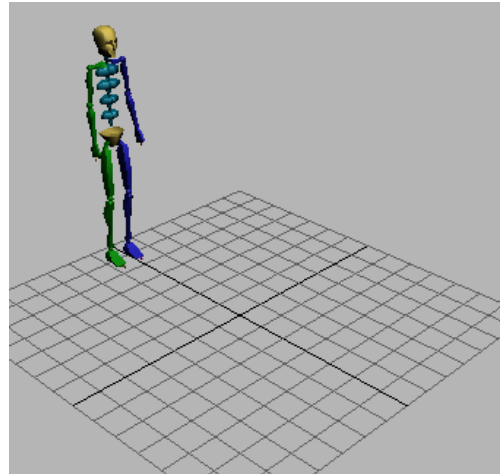

Biped near origin of grid

3. Maximize the Perspective viewport by pressing **ALT+W**.

4. Click any part of the biped to select it.

A white box outlines the selected body part.

5.  Open the Motion panel.

The Biped controls are displayed. Figure mode is active.

Next you'll turn on Footstep mode. Figure mode turns off automatically.

Create multiple footsteps:

1.  On the Motion panel, in the Biped rollout, turn on Footstep Mode.

 The Footstep mode button turns yellow, and the Footstep Creation and Footstep Operations rollouts are displayed.

2.  In the Footstep Creation rollout, click Create Multiple Footsteps.

The Create Multiple Footsteps: Walk dialog is displayed. Here you see many parameters for creating multiple footsteps. You'll only change

the number of footsteps, leaving the other defaults as they are.

3. In the General group of the Create Multiple Footsteps: Walk dialog, change Number Of Footsteps to **8**, and then click OK.

Footprints are displayed in white in the viewport. These are inactive footsteps. They do not yet control any animation for the biped. If you press the Play Animation button, the biped won't move.

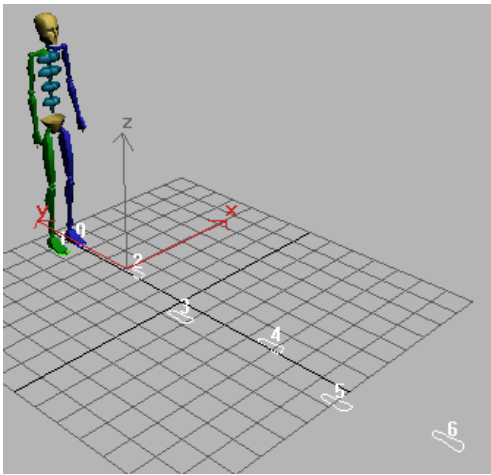

Inactive footsteps

4.  In the Footstep Operations rollout, click Create Keys For Inactive Footsteps.

The footsteps are activated. Animation keys are created for the biped.

5. Play the animation.
The biped walks.

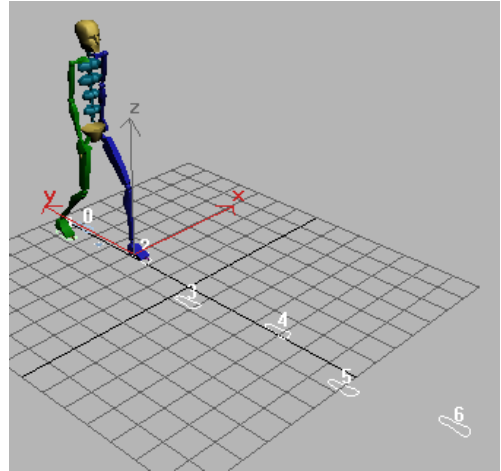

The biped takes a step.

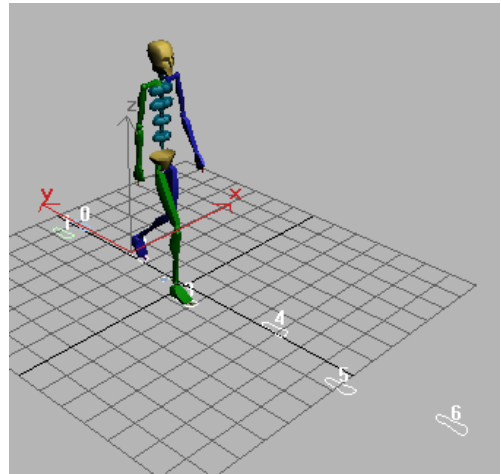

The biped takes another step.

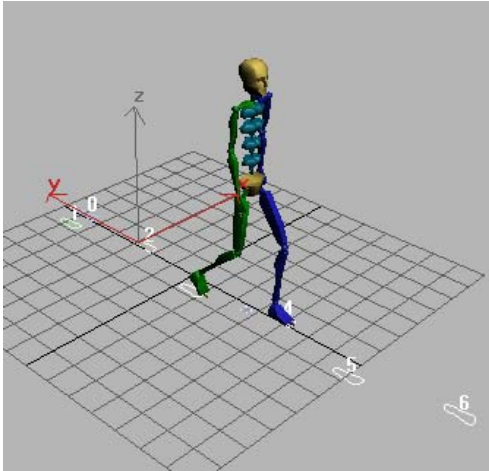

The biped keeps on walking.

- On the Biped rollout, turn off the Footstep Mode button.

Notice that the first footstep is numbered 0, and the last footstep is numbered 7.

-  In the Track Selection Rollout, click the Body Horizontal button. This selects the horizontal position track for the center of mass (COM) object.

The track bar displays keys for the length of the animation.



Body Horizontal keys

-  In the Track Selection rollout, click the Horizontal button to turn it off, and then click the Body Vertical button.

The same keys are visible in the viewport.



Body Vertical keys

- Play the animation.
The biped walks, but without much character.

In the following procedures, you'll begin individualizing the motion by adjusting the keys for the Body Horizontal, Vertical, and Rotation tracks. You'll exaggerate the rotation of the center of mass to create a more energetic walk.

Adjust body rotation keys:

-  In the Perspective viewport, use Arc Rotate to shift the view so that the biped is walking toward you. Then move the time slider to frame 0.

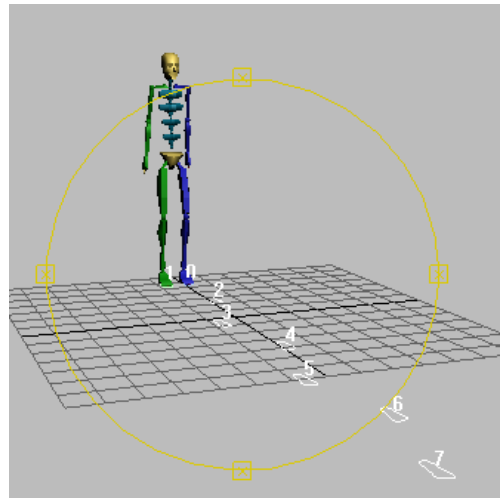

-  Be sure a part of the biped is still selected. In the Track Selection rollout, click the Body Rotation button.

The Transform gizmo displays for rotation. The track bar displays the rotation keys.



-  On the 3ds Max status bar, click the Key Mode button to turn on Key mode.

Key mode lets you use Previous and Next Key buttons to jump between keyframes for the selected object. You can also use the <

and > keys on the keyboard to move between keyframes without clicking the mouse.

3. Press > on the keyboard to move the time slider to frame 24.
4. Use the Transform gizmo to adjust the body rotation. Move your cursor over the gizmo; when the circle turns yellow and the X in the center turns red, press and drag to rotate. If you can't see the X, zoom into the viewport. Rotate **5** to **10** degrees about the X-axis to move the hips down toward the leg that is in motion. When you rotate, one foot will cross the other.

Tip: The rotation is displayed in yellow text above the Transform gizmo, and also in the Coordinate fields on the status bar. You can use the plus (+) and minus (-) keys to change the size of the Transform gizmo.

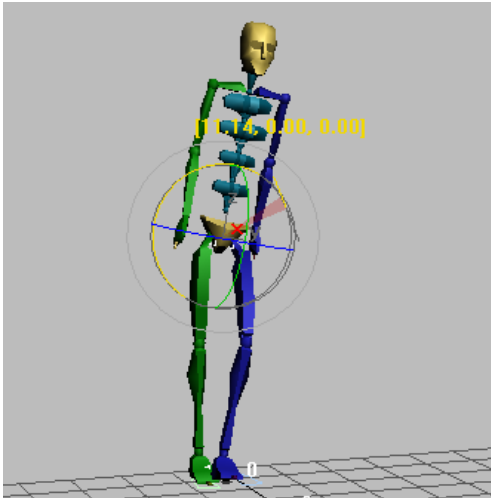

Rotation of the center of mass object about the X-axis

5.  On the Motion panel, open the Key Info rollout and click the Set Key button.

When you set the key, the biped will shift position slightly. In the viewport, you can see that the blue foot is no longer crossing the green.

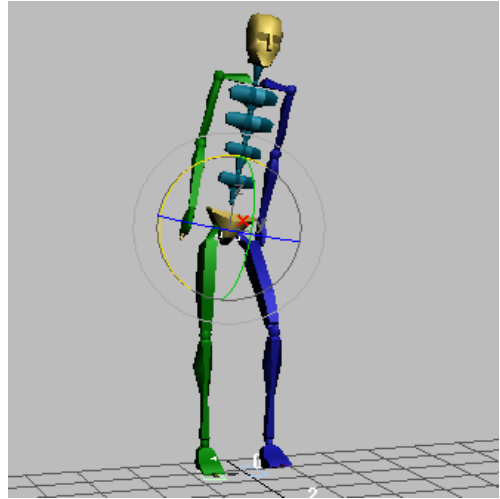

Biped foot snaps away from the other foot.

What is happening is that the foot, calf, and thigh bones are being controlled by the footstep gizmos. The footsteps represent a pair of keys with IK Blend set to 1 and the Join To Prev IK key turned on. When you set the key, these settings force the foot, calf, and leg bones back into the correct path for walking.

6.  Click Next Key three times to move to frame 40.
7. Rotate the Transform gizmo **-6** to **-10** degrees about the X-axis.

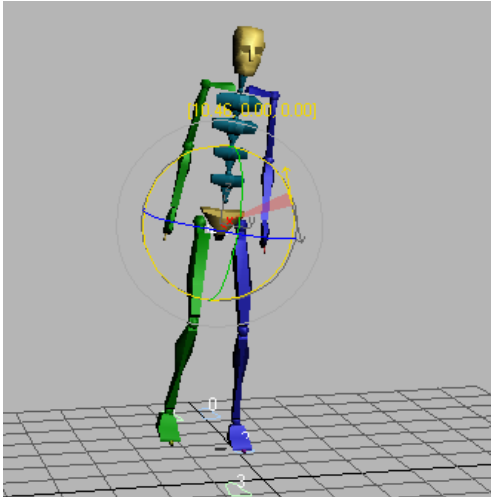

Negative rotation with blue foot in contact with the ground

8. Slowly go through the rest of the rotation keys, repeating this process. At keys where the blue foot comes in contact with the ground (frames 40, 69, and 99), rotate about the X-axis in a negative direction, then set a key. At keys where the green foot is down (frames 55, 84, 116), rotate about the X-axis in a positive direction, then set a key.

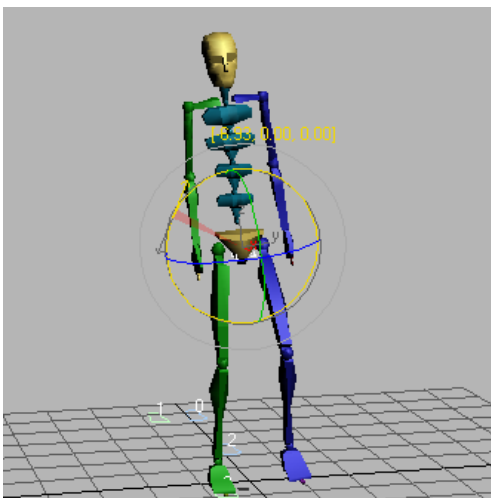

Positive rotation at frame 54

9. Repeat this pattern until you have finished rotating the COM at the end of the animation. Don't make your adjustments too precise. Slight variations from frame to frame make the motion look more natural.

When you are done, play the animation and notice the increased hip swings that result from rotating the center of mass back and forth.

10.  On the Biped rollout, click Save File and save the file as *mywalk.bip*.

If you load the newly saved *mywalk.bip* file into a scene containing a skinned character, the character will swing its hips according to the instructions you saved in this file. Play the animation to determine if you need to adjust it. For instance, Dr. X (from the quick start tutorial) has huge feet, which may need to be moved further apart so they don't pass through the legs accidentally.



Dr. X character with distinctive walk

Add spring to the step:

1. Continue from before, or load *mywalk.bip* that you saved.

To load a BIP file, create or select a biped. On the Motion panel, in the Biped rollout, click File Load and open the file. This transfers all the movement information in the file to the biped.

2.  In the Track Selection rollout, click the Body Vertical button.

This selects the vertical position track for the center of mass object.

3.  Turn on Key Mode, if it isn't already on.
4. Starting at frame 0, move through the animation using the < and > keys. When you come to a frame where either a green or blue foot comes in contact with the ground, move the COM down just a few units.

The knees will bend because the feet are controlled by the footsteps.

5.  In the Key Info rollout, press the Set Key button after making a change at a frame.
- This sets a key for the change you've made in the viewport. Otherwise the change is discarded.
6. Play the animation.

The biped walks with newfound bounce.

7.  On the Biped rollout, click Save File. Name the file *mywalk2.bip*.

Add arm and hand motions:

Arm and hand motions are an integral part of an individual's gait. In the following sequence, you'll customize the arm motion by moving the hands and rotating the arms.

You previously created keyframes using the Set Key button; however, for this technique, you'll use Auto Key instead.

1. Continue from before, or load *mywalk2.bip*, the file you saved earlier. If you prefer, you

can begin at the end of the last procedure by opening *springstep.max*.

2.  In the 3ds Max status bar, turn on the Auto Key button.
3. Move the time slider to frame 0.
4. Dragging the time slider to the right, flip through the frames of animation. Drag forward and backward, and watch how the arms and legs swing. Study the motion carefully.

When the green foot is extended, the blue arm swings forward. When the blue foot swings out, the green arm swings forward. See if you can find the frame at which the hand extends the farthest forward.

5. In the viewport, select the green hand of the biped (*Bip01 RHand*).
The track bar displays the keys for the hand.
 6. Move the time slider to frame 30.
- There is a key in track bar at that frame for the hand object.
7. Right-click the hand, and choose Move from the quad menu.

Using the Transform gizmo, move the hand approximately **10** units upward on the Z-axis.

By moving the hand, you've also rotated the two arm bones. The keys for the hand and arm bones are stored on a single track.

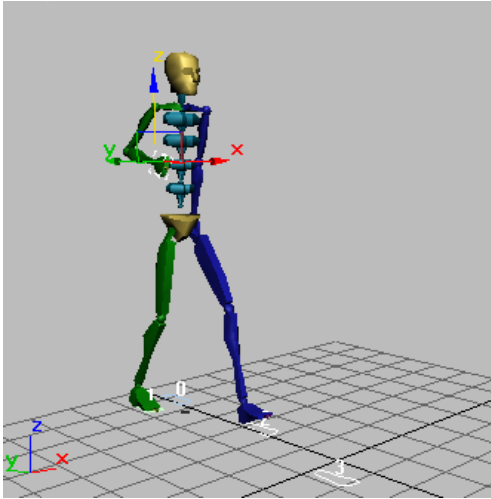

The hand moved upward

8. Select the *Bip01 R UpperArm* object, then right-click and choose Rotate. Rotate the upper arm approximately **-30** degrees about the Z-axis.

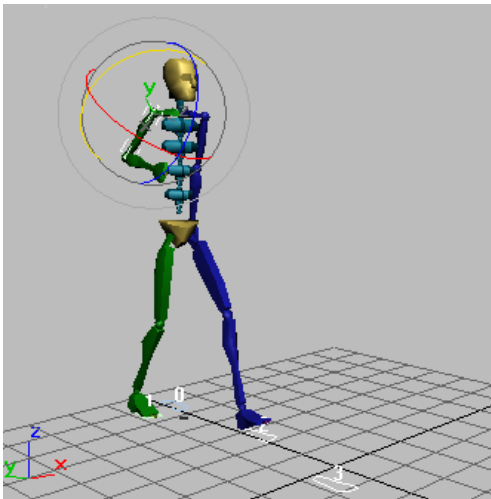

The upper arm rotated around the Z-axis

9. Rotate the upper arm approximately **20** degrees about the Y-axis, so the elbows are flying out and away from the body.

10. Select the forearm object (*Bip01 R Forearm*) and rotate it so the hand moves closer to the chest.

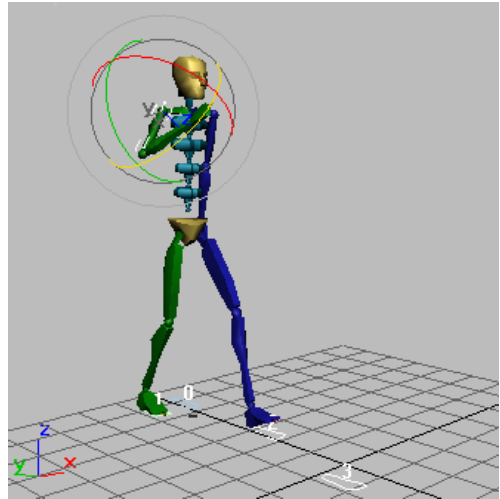

The hand rotated close to the chest

You can position the arm using forward kinematics (the rotation of the parent objects) or inverse kinematic (using position transform on the end of the chain, in this case the position of the wrist.) You can also rotate the hands.

11.  Use Arc Rotate to revolve the viewport so you can see the angle of the other arm behind the biped.

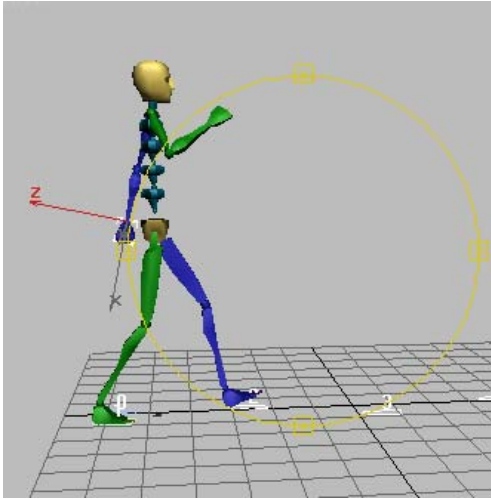

View of the arm behind the biped

12. Select the blue hand, and right-click to choose Move. Move the hand further away from the biped's body. Then move the blue hand upward on the Z-axis so the elbow bends slightly.

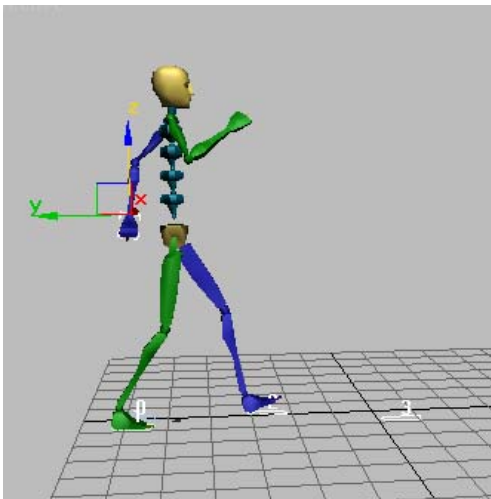

13. Move the time slider back and forth to observe the animation so far.
14. Repeat the process at frames 60 and 90.
15. Repeat for the other side at frames 45 and 75.

Tip: If you want exact duplication of these arm positions, you can use the tools in the Copy/Paste rollout. Select both arm assemblies, create a collection, then use Copy Posture and Paste Opposite at the correct frames. See *Creating a Simple Freeform Animation* (page 1-344) for information on using those features.

16. Play the animation.

Save it as *mywalk3.bip*.

17. To see your work on a skinned character, open *cs4_qs_DrX04.max* from the *tutorials\character_animation\quick_start* tutorial folder, and then load your *mywalk3.bip* file. For comparison, you can also load *distinctive_walk_final.bip*. Remember to select part of the biped to access the Biped rollout.





Dr. X with spring in his step

Add head motions:

You can edit the head motion to make the biped's walk look more natural. In this procedure, you'll add head rotations to accentuate the COM rotation.

1.  Turn on Auto Key, if it isn't on already.

2.  Turn on Key mode, if it isn't on already.
3. Move the time slider to frame 0.
4.  In the Perspective viewport, select the biped's head using Rotate on the 3ds Max Main toolbar.
5. Rotate the head down as if the biped is asleep.

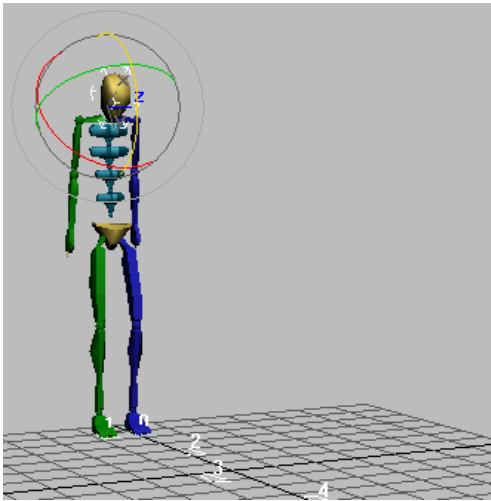

The head rotated downward

6. Move the time slider to the next keyframe by pressing the > key on the keyboard.
7. Keyframe rotations for the head. You can rotate the head to counterbalance the angle of the shoulders. Or, you can rotate the head in the opposite direction so it follows the rotation of the COM. Each rotation will give a different result. Extreme rotations should be avoided. Also, be careful to put the rotations only on existing keys.

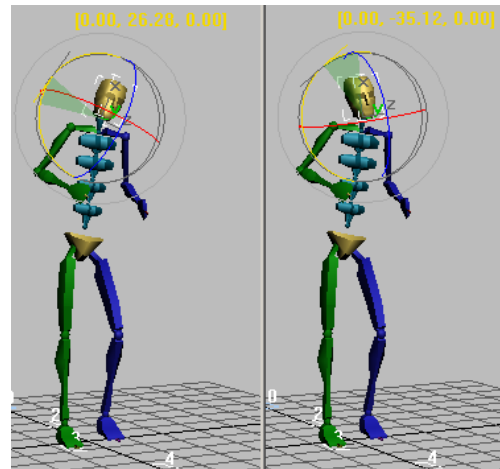

Rotate the head to follow the movement, or rotate the head to oppose the shoulders.

8. Continue to jump through the head's keys, setting rotations of your choice to animate the head.
Natural head motion is smooth, so the orientations should change gradually from one key to the next.
9. Turn off Auto Key and Key Mode.
10. Play the animation, and notice how much the biped's head movements add to the animation.
You can now save your work as *mywalk4.bip*. You can check your file against *head_rotate_with.bip* and *head_rotate_against.bip*.



Dr. X's distinctive walk with head rotation

Modifying Footsteps



In this lesson, you'll learn how to copy and paste biped footsteps to extend an animation. You'll also learn how to adjust and bend the steps, and to produce the effect of walking on uneven terrain. You'll also make the biped take a jump.

Set up for this lesson:

- Continue from the previous exercise, or open *paste_footsteps_start.max*.

Extend the walk:

1. Select any part of the biped.
2.  On the Motion panel, in the Biped rollout, turn on Footstep Mode.
The Footsteps sub-object level is activated, and only the footsteps can be selected.
3. Right-click to activate the Top viewport, then press **ALT+W** to maximize the viewport.
4. Using Select And Move, region-select footsteps 3 through 7.

5.  On the Footstep Operations rollout, click Copy Footsteps to place the selected footsteps into the footstep buffer.
6.  Click Paste Footsteps to paste the selected footsteps into the viewport.

The new footsteps appear next to the biped's current footsteps.

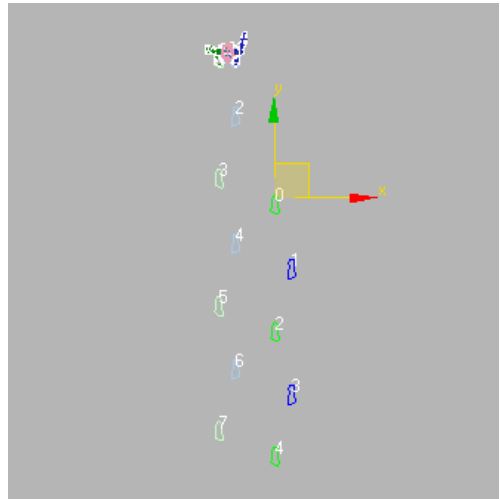

Pasted footsteps appear.

Tip: If you have Transform gizmo on, use the minus key (-) to shrink the Transform gizmo, so it doesn't cover up the footsteps.

7. The new footsteps can be moved as a set. Move them so the first footstep of the new set is over footstep 7 of the original set. When footstep 7 of the original set turns red, release the mouse button.
Footsteps from the original motion are inserted. Now there are 11 footsteps visible.
8. Press **ALT+W** to display four viewpoints.
9. To display the entire animation in the Perspective viewport, zoom out and use Arc Rotate and Pan to adjust your view until the biped and all 11 steps are visible.

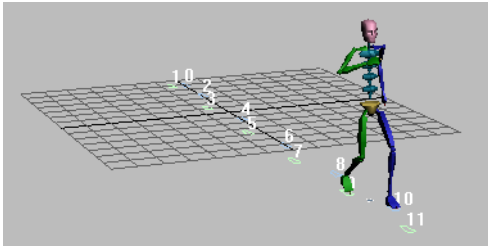

Pasted footsteps extend the motion.

10. With the Perspective viewport active, play the animation.

Since you are still in Footstep mode, the Motion panel is available. This is a good time to save your *mywalk_pasted.bip* file, using Save File on the Biped rollout.

Scale the walk:



1. Make sure Footstep mode is active.
2. In the Top viewport, region-select all the footsteps.
3. On the Footstep Operations rollout, turn off Length, and leave Width selected.
4. Set Scale to **2.0** to double the spacing between the left and right footsteps.
5. Play the animation.
The biped walks with legs apart.
6. Set Scale to **0.25** or smaller to reduce the spacing between the left and right footsteps to half of the original scaling (one-quarter the current setting).

If you hadn't previously doubled this parameter, a setting of 0.5 would have scaled the width by 50%.

Now the biped puts one foot in front of the next.

Tip: If your character has big feet, or if it's walking on a wire or a ledge, use Scale Width and Length to adjust the footsteps.

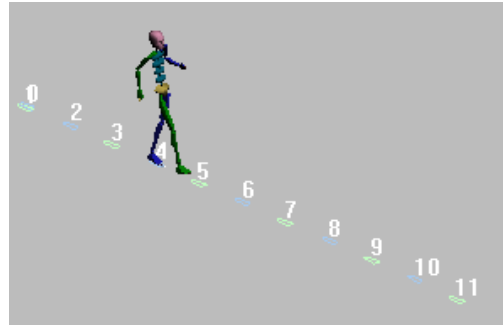

Scale the width between the steps.

7. Play the animation.
The biped walks as if on a tightrope.

Bend the walk:

1. In the Top viewport, select all the footsteps from 7 on.
2. On the Footstep Operations rollout, set Bend to **20.0**.
The footsteps bend to the left, beginning at footstep 7.
3. Play the animation.



Walk on uneven terrain:

You can raise and rotate the footsteps to create the illusion of walking on uneven terrain.

1. Make sure that Footstep mode is still on.
2. Maximize the Perspective viewport.
3. Use Select And Rotate to select all the footsteps from 4 on.

4. Use the Transform gizmo arrows to rotate the selected footsteps approximately **-15** degrees about the X-axis so the footsteps go up a hill.
5. Select footsteps 8 through 11.
6. Rotate the selected footsteps about the X-axis approximately **21** degrees, so that the footsteps go back down the hill.
7. Select footstep 11. Rotate it so it's parallel with the grid.
8. Play the animation.

The biped's feet follow the footstep placement.

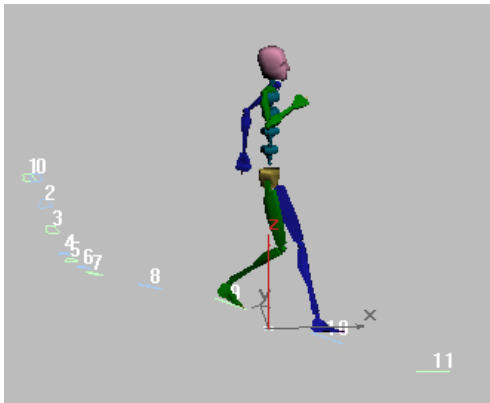

Add a jump:

If there is a period of time during a footstep animation when neither foot is on the ground, the software interprets this period as a jump. There are several different ways to create a jumping animation. In this set of procedures, you'll move footstep keys in Track View to make the jump.

- Open *footsteps_jump_start.max*.

This is a slightly longer version of the same file you've been working on. It has 15 footsteps instead of 11.

Move footstep keys in Track View:

1. Select *Bip01*. On the Motion panel, in the Biped rollout, turn on Footstep Mode, if it isn't already on.

2. In the viewport, right-click and choose Curve Editor from the quad menu.

Track View is displayed.

3. On the Track View menu bar, choose Modes > Dope Sheet.

The *Bip01 Footstep* track is displayed in Track View.

Tip: If this track is not displayed, turn on Footstep Mode, and the track will appear as long as you're in the Dope Sheet editor.

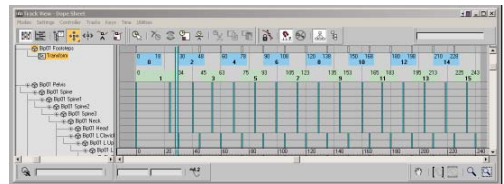

Dope Sheet shows special footstep keys.

In the illustration above, each blue block represents a left footstep, and each green block represents a right footstep. The length of the blocks is the period of time that the foot is in contact with the ground during the footstep. The spaces between the blue and green blocks represent periods in which the biped is not supported by the left or right foot.

4. Navigate the viewport using Zoom and Pan until you can see the biped and the footsteps, as well as the Footstep keys in Track View.
5. Resize the Track View window, or zoom into the track so you can see the start and end frame numbers on each footstep.
6. Select footsteps 11 through 15 by drawing a box around them in Track View, or by dragging a selection region in the viewport.

In Track View, notice that footstep number 11 starts at frame 165.



7. On the Track View toolbar, click the Slide Keys button.

- In Track View, click in the center of footstep 11 and drag it to the right until the number 166 (indicating the first frame of footstep 11) increments to number 180. Release the mouse button.

This creates a gap between step 10 and 11. The keys in the other biped tracks adjust to the change in the footstep track.

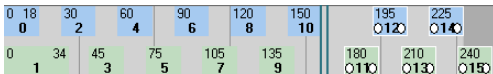

The keys shifted to the right to create a gap

By creating an area in the footstep track where neither foot is supporting the biped, you have changed a walking step into a jumping step

- Play the animation.

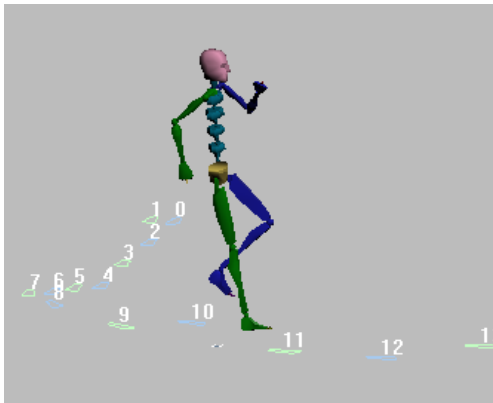

The gap between footsteps creates a jump.

- In the viewport, move footstep 10 so it is next to footstep 9.
- In the viewport, move footsteps 11 through 15 so there is more of a gap for the jump. Move these footsteps about 5–7 units in the X-axis direction.

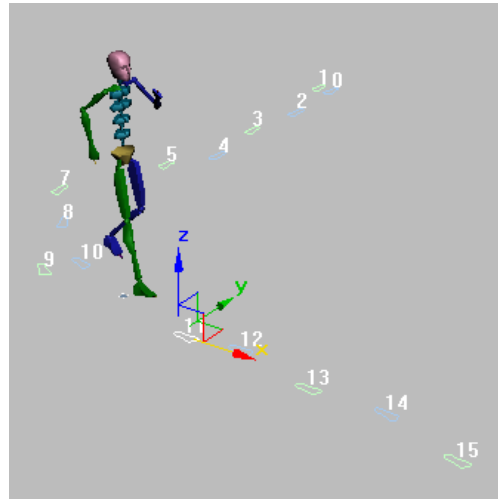

More gap for the jump

Now, if you shorten the duration of footstep 10, you can accentuate the jump.

- On the Track View toolbar, click Move Key.
- In Track View - Dope Sheet, click the right edge of footstep 10. A white dot appears only on the right side of the key to show it's selected.
- Drag the right edge of footstep 10 to the left to shorten the duration of the key. Change the key so it ends at frame 160.





Shorten the duration of footstep 10.

- Play the animation and observe the jump.
- Turn off Footstep Mode.

Make the biped crouch before the jump:

The preparation for the jump, between footsteps 9 and 10, looks a little stiff because the biped is not

crouching enough before jumping. Resetting a vertical key will fix this.

1.  On the Motion panel, in the Track Selection rollout, click Body Vertical.
2. Move the time slider to frame 153, where there is a Body Vertical track key.
3.  On the Motion panel, in the Key Info rollout, click Set Key.
4. Press **H** and select Bip01, the center of mass.
5. Move the center of mass down approximately -5 units. If the biped jumps back to its original position, click Set Key and try again. Click Set Key when you have a crouching position as illustrated here.

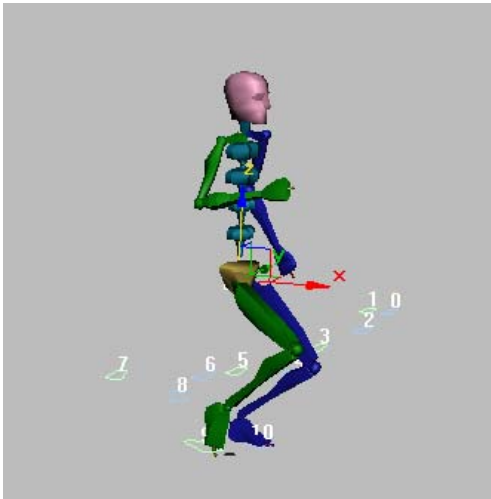

Lower the center-of-mass object using the Body Vertical track.

6. Move the time slider to view the animation. There appears to be a glitch in the motion. There are two Body Vertical keys next to each other that are causing this problem.
7. Move the time slider to frame 153.

8. In the Key Info rollout, click the Next Key arrow to move to the next key at frame 154. Click Delete Key to remove this second key.
9. Select *Bip01 R Foot*.
10. Move the time slider to frame 167. Click Body Vertical and raise the foot slightly, so the biped's knee is bent.
11.  Set a free key to hold the bent knee position. Set additional keys on the foot if it hyperextends before it hits the ground, or if it goes through the ground at takeoff.
12. Play back the animation and observe the motion.
13. In the Track Selection rollout, click Body Rotation. Move the time slider to frame 160. Using the Transform gizmo, rotate the center of mass so the body pitches forward.

The jump looks more natural now. The result should be similar to the jump in *footstep_jump_final.bip*.

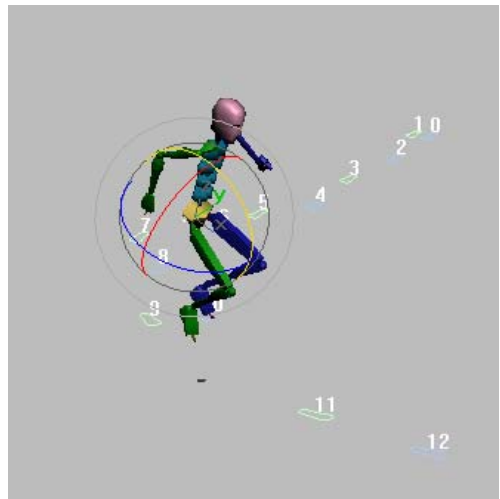

Making a Biped Stop and Start Walking

In just a few key strokes, you can generate multiple footsteps to make a biped walk. But what if you want the biped to stop and pause? To do that, you'll use a simple manipulation of the footstep keys in the Track View - Dope Sheet. Just stretching the length of the selected footsteps changes the animation so the biped pauses in its path.

Make the biped stop and start:

1. Open *standstill_start.max*.

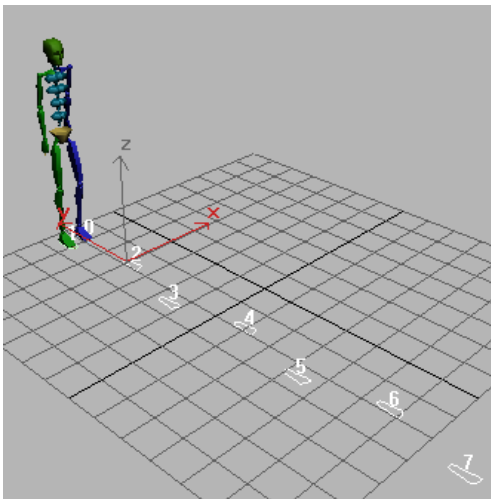

2. In the viewport, select any part of the biped.
3. Open the Motion panel.
The Biped controls are displayed in the rollouts.
4. Play the animation of the biped by pressing the Play Animation button in the VCR controls.
The biped walks seven steps forward without stopping.

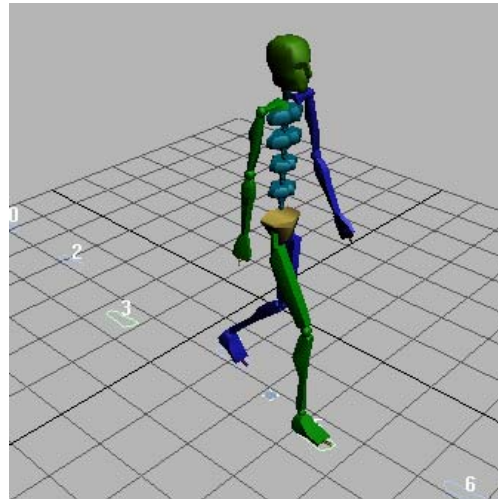

You'll use footsteps 4 and 5 as the footsteps where the biped pauses.



5. In the Biped rollout, turn on Footstep Mode.
6. In the Perspective viewport, select footsteps 5–7, then right-click and choose Move.
7. Move the footsteps so that footstep 5 is next to footstep 4.

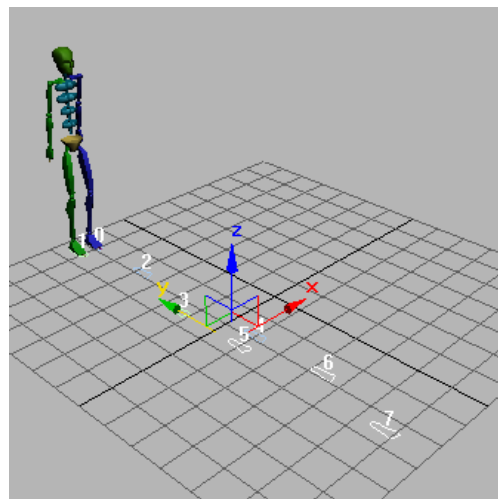

- Play the animation to observe the change.

The animation looks a little funny right now; something's not quite right.

It's good practice to deactivate the footsteps, and then create new keys from the moved footsteps. This will recreate the correct upper body motions. You'll do that next.

Create keys to correct upper body motions:

- Select footsteps 4–7 in the viewport. On the Motion panel, in the Footstep Operations rollout, click Deactivate Footsteps.

To manipulate the footstep keys, you'll use Track View in Dope Sheet mode.

- On the 3ds Max menu bar, choose Graph Editors > Track View - Dope Sheet.

The Dope Sheet opens, and the footstep tracks are displayed.

- Right-click the top of the Track View window and choose Dock > Bottom.

The Dope Sheet moves out of the way of the viewports.

- Make adjustments as needed to your viewport so you have a clear view of the footsteps and the biped. When you select footsteps in the viewport, you also select footstep keys in Dope Sheet.

- Select footsteps 4–7 in the viewport, if they aren't already selected.

In the Dope Sheet, the selected keys appear with white dots on them.

- Press ALT and click the white dot at the left side of footstep key 4. This deselects the left side of that footstep key. Repeat for key 5, deselecting the left side of the key.

Keys 4 through 7 are selected, but keys 4 and 5 display only one white dot.

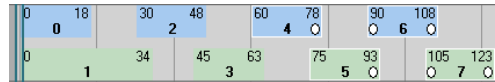

- From the right side of key 5, drag to the right so the key ends at frame 200.

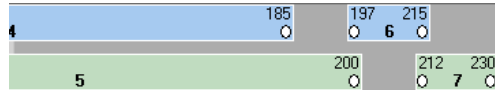

- On the keyboard, press **ALT+R** to extend the animation to match the footstep keys.

Frames are automatically added to the animation.

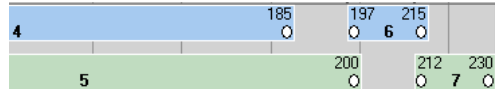

The light grey background extends behind the footstep keys. The time slider now shows that there are 230 frames in the animation.

- Play the animation and observe the biped motion.

The biped walks, then stops and waits, and then walks again. The motion seems a bit odd, though, as he steps off around frame 180.

Tip: There are a number of different ways to play and observe biped motion. One way is to drag the time slider to play the animation. For more control, press the < and > keys on the keyboard. This lets you stop instantly if you see a problem, and is more like a traditional animator flipping through the pages of drawings.



- In the Footstep Operations rollout, click Deactivate Footsteps.

In the Dope Sheet, the footstep keys change color.



- In the Footstep Operations rollout, click Create Keys For Inactive Footsteps.

In the Dope Sheet, the footstep keys change back to their earlier color.

12. Play the animation again.

The motion is better. When new keys are created, the software applies a new upper body motion.

Tip: For this reason, when animating starting with footsteps, work out the foot motion before you worry too much about the upper body motion.

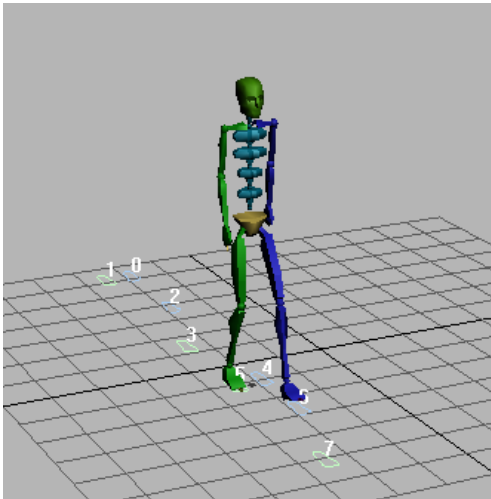

13. Save your work as **my_standstill.bip**, or open *standstill_final.max* to check the completed file.

Animating a Gymnastic Flip

In this lesson, you learn to animate a biped to produce two realistic back flips, including the windup and proper in-air motions for the legs, arms, and upper body. As a final step, you add a twist to the flips.

In the startup file, the jump sequence has already been set up for you. It's a basic, eight-footstep backward jump produced with the Create Multiple Footsteps dialog. The last pair of steps have been

moved in to reduce the jump height of the final hop.

Set up for this lesson:

1. Open *flip_start.max*.

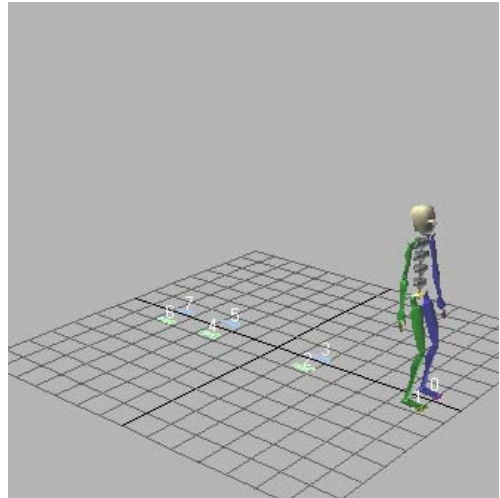

2. Select any part of the biped, then open the Motion panel.

3.  Activate the Front viewport. Play the animation using the Biped Playback button on the Biped rollout. Observe the movement of the stick figure, then click the button again to turn off Biped Playback.

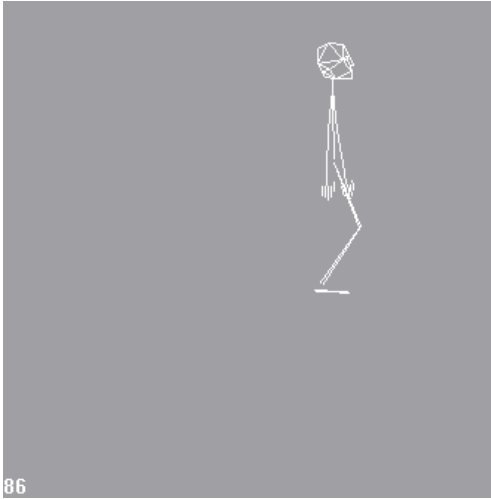



86

Biped playback

4. Activate the Perspective viewport. Play the animation by clicking the Play Animation button on the 3ds Max status bar.

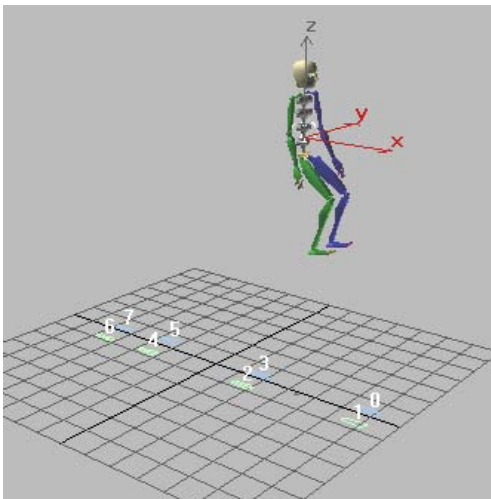
Notice that the upper body appears mechanical, although the biped leans slightly into the jump and bends its knees in anticipation of the jump.

*Animation playback*

5.  Click the Time Configuration button to open the Time Configuration dialog. In the Playback group turn on Real Time, and set the Speed to **1x**. Click OK to close the dialog, then play the animation again.

This slows down the playback step so you can see the animation motion better.

Next, you will add two flips to the motion. Adding a flip involves setting rotation keys for the body by rotating the center of mass object *Bip01* while the body is in the air. If the feet are not touching the ground, rotating the center of mass rotates the entire body. If the feet are planted on the ground, rotating the center of mass rotates only the upper body.

You want the biped to rotate 360 degrees during a flip. To do this, you need to define at least two turning keyframes in the air to make the biped flip all the way around in the same direction.

Add the first flip:

1.  On the Motion panel, in the Track Selection rollout, click Body Rotation to select rotation track for the center of mass (COM). The Rotation Transform gizmo appears in the viewport, with the COM automatically selected.
2. Move the time slider to frame 31, at the top of the first jump.
3. In the Perspective viewport, rotate the biped approximately **-94** degrees about the Y-axis, so he is facing the sky and his back is parallel with the ground plane.

The rotation is displayed in yellow above the Transform gizmo as the biped rotates.

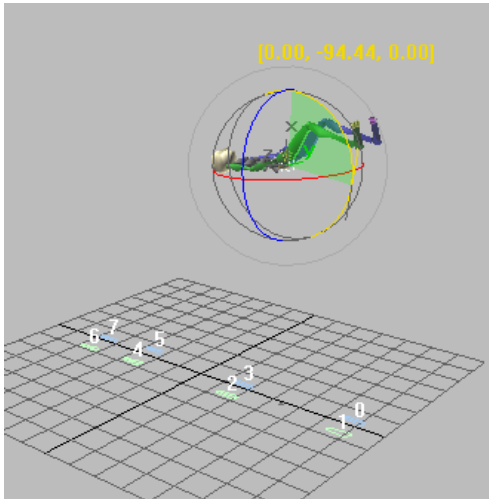

Rotation at frame 31

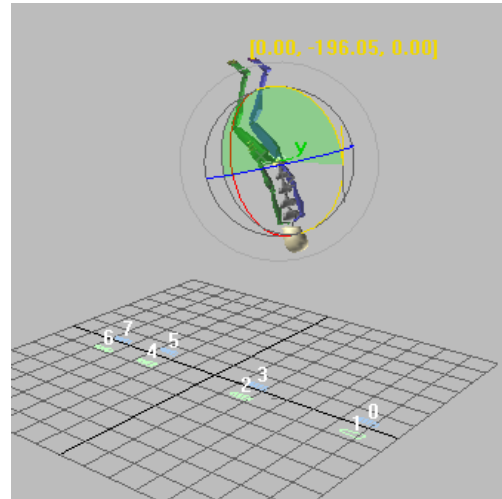

Rotation at frame 42

4.  On the Key Info rollout, click Set Key to set a rotation key at frame 31.
5. Move the time slider to frame 42.
The biped rotates back as a result of continuity with other keys. The next step corrects the rotation to continue the flip.
6. Rotate the biped **-196** degrees about the Y-axis.
The biped is upside down with its feet about to come back down.



7.  Click Set Key to set a rotation key at frame 42.

This completes the first flip.

8. Scrub the time slider slowly to examine the flip.

You can use the body keys you just created to produce the second flip. Since the second flip is similar to the first, you can copy body positions from the first flip to equivalent frames in the second flip.

Produce the second flip:

1. Move the time slider to frame 31.
2. Open the Copy/Paste rollout.
3.   Make sure Posture is turned on, then select the Copy Rotation button.
4.  Click Copy Posture to copy the body rotation to the list of copied postures.
The pose from frame 31 is copied to the buffer. In the Copied Postures list it appears as *Rot1*.
5. Move the time slider to frame 42 and click Copy Posture again.

The pose from frame 42 is copied to the buffer. In the Copied Postures list, it appears as *Rot2*.

6. Move the time slider to frame 74, at the top of the second jump.



7. On the Copied Postures list, choose *Rot1*, and then click Paste Posture.

The biped body rotates into the same position at frame 74 as at frame 31.



8. Click Set Key to create a rotation key for the copied posture.
9. Move the time slider to frame 85. Choose *Rot2* from the list, then click Paste Posture.
10. Click Set Key again.



11. Move the time slider to frame 0, and play the animation.

Now you have two complete flips in the jump sequence.



12. Save your motion data. On the Biped rollout, click Save File, and name the file **myflip2.bip**.

Verify your work:



1. On the Biped rollout, click Load File to open another Biped motion file. On the Open dialog, choose *tutorials\character_animation\tutorial_3\flip2.bip* and click Open.

This motion file contains the same movements that you created in the opening procedures of this lesson.

2. Play this version to verify that your motion sequence is accurate.

You can continue this lesson with this prepared motion file to insure that you are starting from a known point. If your motion sequence is correct,

and you would rather use your own file, you can reload *myflip2.bip* and proceed with the following procedures.

Create the basic windup (or angular momentum) for the flip:

So far, you've set keys for the body turning in midair. Now, to create the impression that the body is preparing for the back flip by whipping itself backward just before liftoff, you need to alter the rotational keys of the body about its center of mass on the ground. Because the feet are planted on the ground, rotating the center of mass rotates only the upper body.

The whipping action also involves the spine and arms, but you'll begin by setting the body's rotation keys about the center of mass.

1. Select any part of the biped.



2. On the Motion panel, in the Track Selection rollout, click Body Rotation.

This selects the center of mass using Select And Rotate.

3. Move the time slider to frame 0. Turn Auto Key on.
4. In the Perspective viewport, rotate the biped approximately **35** degrees about the Y-axis, so the biped bends his upper body forward.

Because the feet are planted on the ground, only the upper body is affected.

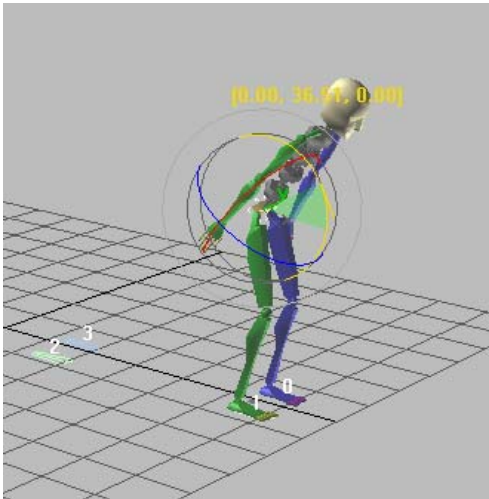

Only the upper body rotates.

- Next, you will add rotation keys to the center of mass at five different frames.

At Frame:	Do this:
10	Rotate the biped 30 degrees about the Y-axis.
20 (liftoff)	Rotate the biped -25 degrees about the Y-axis.
53 (touch-down)	Rotate the biped 15 degrees about the Y-axis.
63 (second liftoff)	Rotate the biped -30 degrees about the Y-axis.
96 (second touch-down)	Rotate the biped 15 degrees about the Y-axis.

- Scrub the time slider slowly to see the windup and landing for each flip.
-  Save your motion data. On the Biped rollout, click Save File, and name the file **myflip3.bip**

Verify your work:

-  On the Biped rollout, click Load File to open another Biped motion file, *flip3.bip*.

This motion file contains the same movements that you just created in the previous procedure.

- Play this version to verify that your motion sequence is accurate.

Now that you’ve made the biped wind up and flip, the next procedures show you how to improve the quality of the movement, to make it look more natural. You do this by working on one body track at a time.

Adjust the first flip:

- Select any part of the biped. Go to frame 10.



- On the Motion panel, in the Track Selection rollout, click Body Vertical.



- Turn on Auto Key. In the Perspective viewport, move the COM down on the Z-axis so the biped bends his knees a little.



- On the 3ds Max menu bar, click Select By Name. select all the biped spine objects from the selection list, then lock the selection (press **SPACEBAR** on the keyboard).

- Right-click in the Perspective viewport and choose Rotate from the quad menu.



- On the Biped rollout, expand the expansion bar. Then, in the Modes group, turn on the Bend Links Mode button.

- Go to frame 0.

- Rotate the spine object **30** degrees about the Z-axis to bend the biped forward.

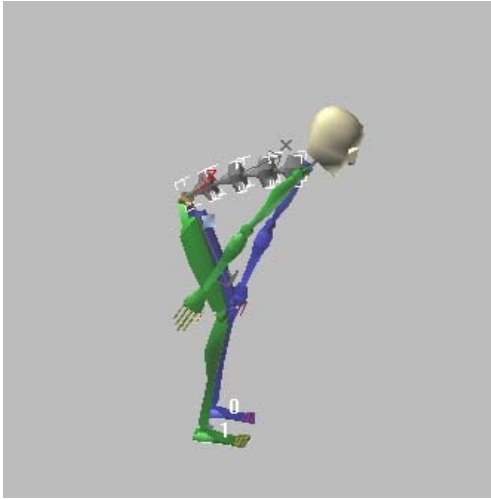

Rotation at frame 0

9. Move to frame 20 where the lift for the jump begins. Rotate the spine -30 degrees about the Z-axis to bend the biped further backward.

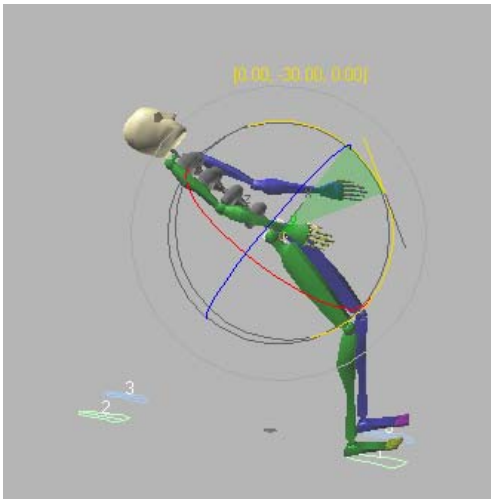

Rotation at frame 20

10.  On the expanded Biped rollout, in the Display group, turn on Leg States.

In the viewport, the status of both feet is displayed as Lift on the footsteps. (You may have to zoom in to be able to read this.)

11. Move to frame 42. Rotate the spine 60 degrees about the Z-axis.

Notice that the biped's back tucks in. This alters the biped's position during the first flip. Next, you'll alter its position during the second flip.

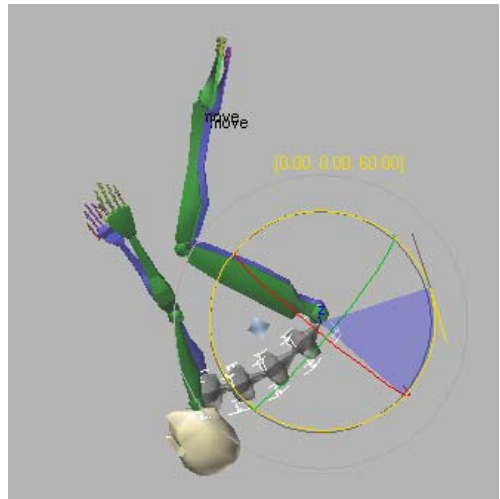

Rotation at frame 42

Adjust the second flip:

1. Move to frame 53. Rotate the spine 20 degrees about the Z-axis.

This is when the biped lands after the first flip. Notice that the status of both feet is Touch.

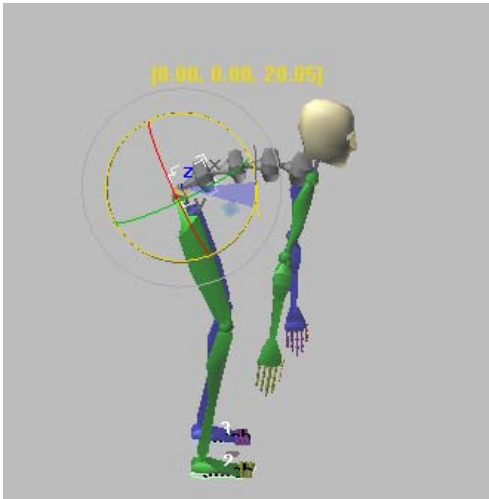

Rotation at frame 53

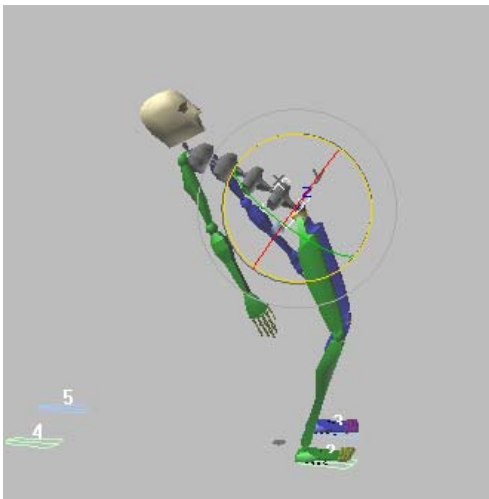

2. Move to frame 63. Rotate the spine **-20** degrees about the Z-axis, so the biped's spine is thrown back in preparation for the next flip. If the biped raises up off the ground, move the COM so his feet touch again, and the knees are bent. At frame 63, the status of both feet is Lift.



Rotation at frame 63

3. Move to frame 85. Rotate the spine **60** degrees about the Z-axis.

The biped changes from a straight posture to a tucked posture.

4.  On the Biped rollout, in the Modes group, turn off Bend Links Mode. Turn off Auto Key.
5. Go to frame 0 and play the animation.
Notice that the biped's upper body now bends as though it was being used to power the motion.
6.  Save your motion data. On the Biped rollout, click Save File, and name the file **myflip4.bip**.

Adjust the legs:

1. Press **SPACEBAR** to unlock the selection. Move to frame 37.
2. Turn on Auto Key.
3. In the Perspective viewport, right-click and choose Rotate.
4. Select either biped foot.
5.  On the Track Selection rollout, click Symmetrical to select both feet.
6. Rotate the feet approximately **50** degrees about the Z-axis, so the toes point up a little more.
7. Right-click and select Move. Use the Transform gizmo corners to move the feet so the knees move between the hands. You might need to readjust the spine rotations to get the hands and knees to match.

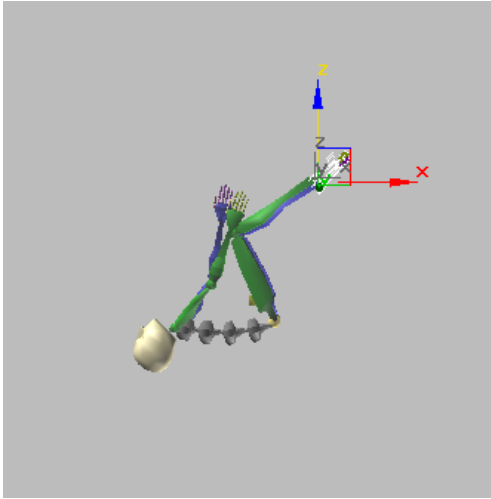

Move the feet to bend the knees.

8. Move to frame 80, the equivalent frame in the second jump. Move the feet again so the knees tuck, and the pose compresses.

Use the file *flip4.bip* for reference and backup.

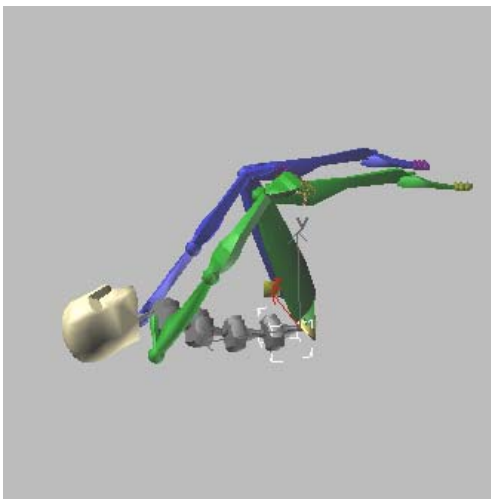



Tucked knee pose

Until now, the biped's arms have been relatively immobile. In a real flip, the arms would begin the flip. In general, arm movement is timed to the spine movement. For the first jump, the arms

begin moving at frame 0 and finish moving at frame 20. They accelerate through that period.

Rotate the arms:

1.  Make sure Auto Key is still on.
2. In the Perspective viewport, right-click and choose Rotate.
3. Select an upper arm object (named *Bip01 R UpperArm*).
4.  On the Motion panel, in the Track Selection rollout, click Symmetrical to select both arms.
5. At frame 20, rotate the arms -150 degrees about the Z-axis.

This makes the arms nearly vertical.

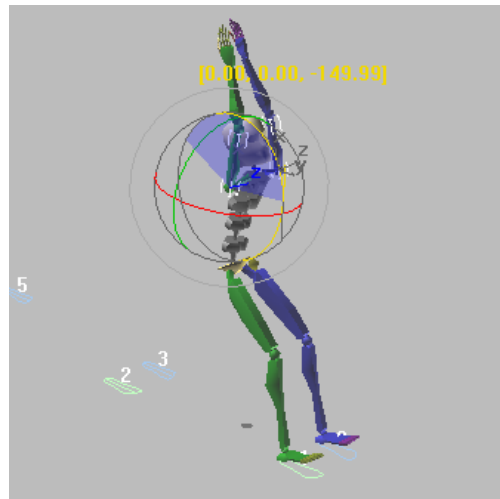

Arms rotated up at frame 20

6.  Move to frame 10, the midpoint of the rotation. click Set Key to lock the rotation. Or you can also right-click the time slider, and use the Create Key dialog to set the keys for the arms.
7. Move to frame 0. Rotate the arms 60 degrees about the Z-axis.

This places the arms just behind the back.

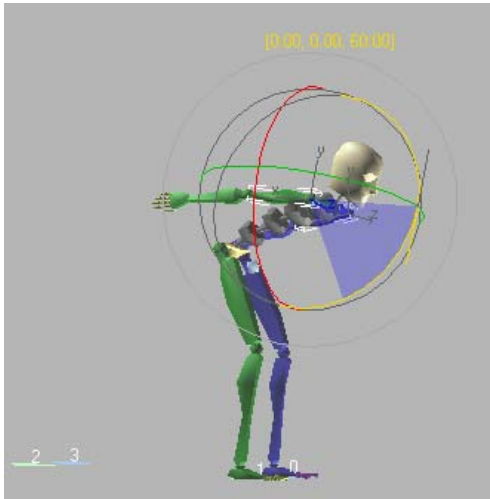



Arms rotated back at frame 0

8. Play the animation.

Tip: On the Time Configuration dialog, in the Playback group, turn on Real Time, and set the Speed to 1/4. This slows the animation playback in the viewport, so you can watch it carefully.

Adjust the arm swing:

At this point, the motion is fine, but the arms should accelerate more. To do this, you'll copy the arm posture from the first third of the motion onto the arms in the middle of the time sequence. The result will be slower motion in the first half of the sequence and faster motion in the second half.

1. Turn on Auto Key if it isn't on already.
2. At frame 6, double-click an upper arm to select the entire arm.
3.  On the Track Selection rollout, click Symmetrical to select both arms.
4. On the Copy/Paste rollout, turn on Posture and click the Copy Rotation button.
5.  Click Copy Posture.

The posture of the arms is copied into the list. It is named *RotLArmRArmLFingRFing*.

6.  Move to frame 10. Click Paste Posture.
7. Play the animation.
8. Move to frame 53. Right-click the time slider, turn off Position and Scale, then click OK to create keys for the arms.

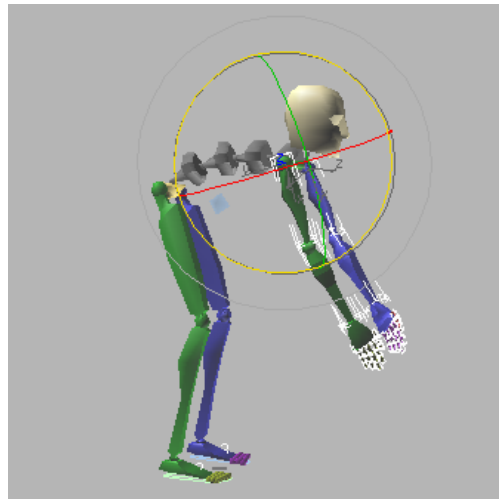

9. Deselect both arms. Then select an upper arm object, and click Symmetrical.
10. Move to frame 63, the liftoff point. In the Perspective viewport, right-click and choose Rotate.
11. Rotate the arms -150 degrees about the Z-axis, so the arms raise up.

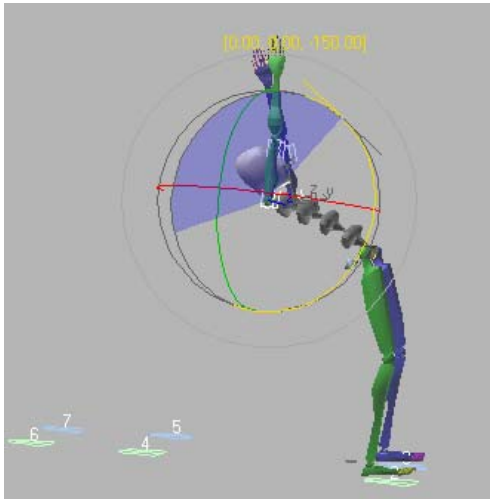

Rotation at frame 63

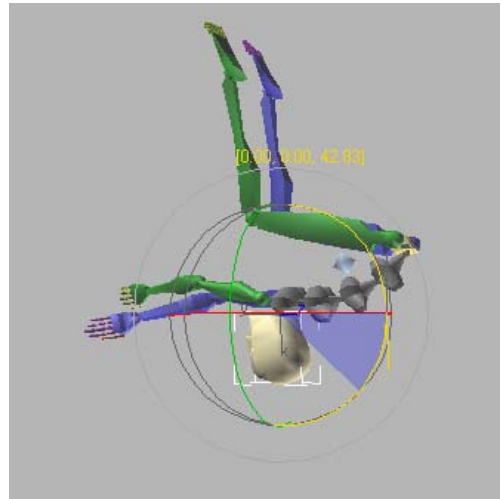

Biped head rotation at frame 42

Move the head:

In general, the head will bend with the spine as it tucks, but will be more vertical when the feet are planted.

1. Move to frame 20. Make sure that Auto Key is still on.
2. Select and rotate the head **-40** degrees about the Z-axis.
3. Scrub the time slider forward and watch the head rotation.

As a result of spine and center of mass rotations, the head is thrown back too far at frame 42.

4. Move to frame 42. Rotate the head **40** degrees about the Z-axis.

5. Move to frame 53, a touch-down point, where the biped would be looking up from the tuck. Rotate the head **-12** degrees about the Z-axis.

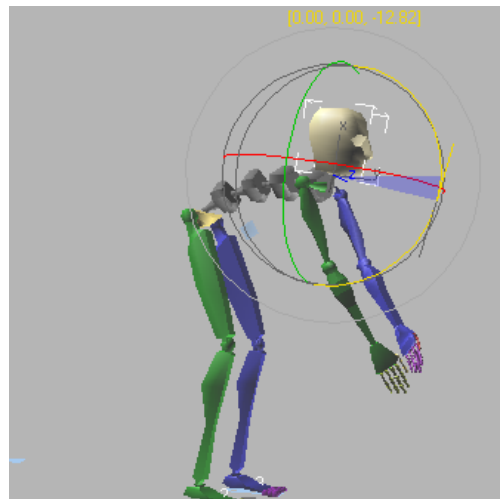

Head rotated up at frame 53

6. Move to frame 63, where the head would be thrown back as part of the jump. Rotate the head **-40** degrees about the Z-axis.

The biped is looking straight up at the sky.

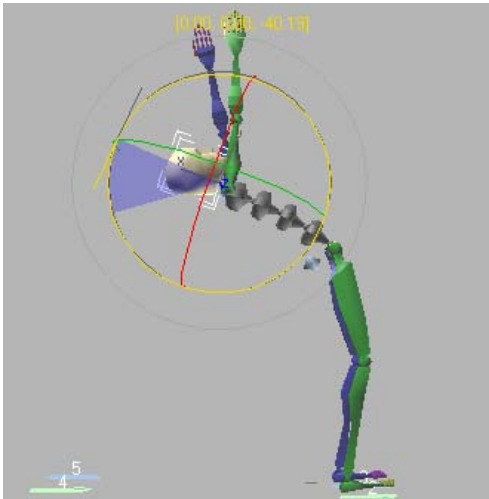

Head thrown back at frame 63

7. Move to frame 71. Rotate the head **15** degrees about the Z-axis.
8. Move to frame 85, the same point in the flip as frame 42. Rotate the head **40** degrees about the Z-axis.

This tucks the chin into the chest between the arms.

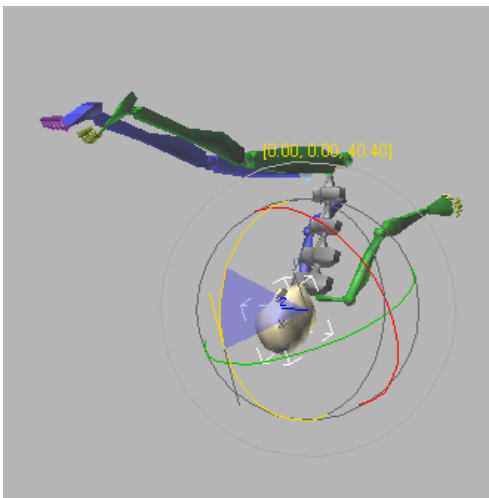

Chin tucked in at frame 85

9. **Auto Key** Turn off Auto Key. Go to frame 0, and play the animation.

There is a problem with the arms at frame 85. You can fix that by copying the posture of the arms at frame 84, and then pasting it at frame 85 with Auto Key turned on.

You can also add additional keys to change the arm movement as you like. In the provided file, the biped tries to keep his hands on his knees, but during the second flip he lets go and his arms flip around.

10. Save your motion data as **myflip5.bip**.

You can load *flip5.bip* to check your changes.

Now that you have a good-looking jump and flip, it's time to add a twist. The easiest way to accomplish this is to rotate selected footsteps and let the biped automatically adapt.

Twist the footsteps:

1.  On the Biped rollout, turn on Footstep mode.
2. In the Top viewport, region-select footsteps 2 and 3.
3. Drag up on footstep 2 to rotate the footsteps **-180** degrees about the Local Z-axis.
4. Right-click and choose Move. Move footsteps 2 and 3 about the Y-axis, in line with the other footsteps.

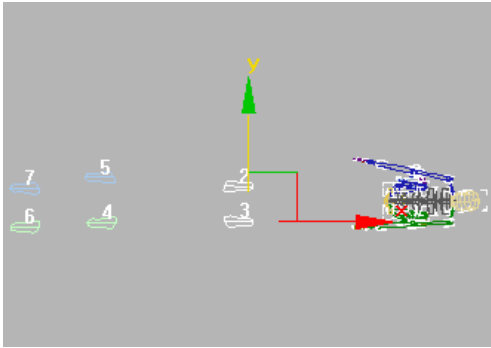

Footsteps rotated and moved

5. Play the animation.

You'll see the biped do a half twist in the first jump. It will also do a backward half twist in the second jump. You'll fix that next.

6. In the Top viewport, right-click and choose Rotate. Region-select footsteps 4, 5, 6, and 7.
7. Drag up on footstep 6, and rotate the footsteps **-180** degrees about the Z-axis.
8. Right-click and choose Move. Drag the footsteps so footstep 6 is on top of footstep 0.

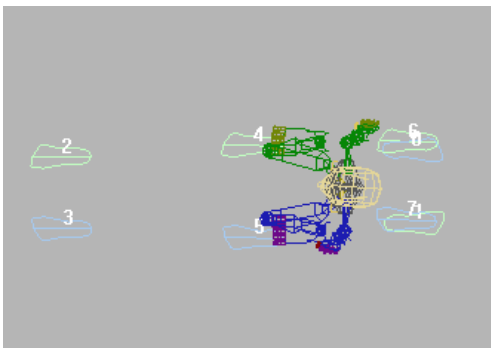

9. Play the animation again.

The biped does a half twist in the first jump. The second jump is a simple flip ending with the biped facing the opposite direction.

10. Load *flip6.bip* to verify that your motion sequence is accurate.

In the following procedure, you'll move some of the footsteps to simulate a jump from higher to lower platforms.

Add height to the flip:

You'll use a Track View selection technique to select footsteps 0 and 1, because they are covered by footsteps 6 and 7.

1. Make sure Footstep mode is still on.
2. On the Graph Editors menu choose Track View – Dope Sheet.

The Dope Sheet editor opens. *Bip01Footsteps* are displayed in the track as blue and green blocks.

3. Region-select the blue and green footstep blocks numbered 0 and 1 to select the footsteps. Then close the Dope Sheet window once the selection is made.
4.  Click Move. In the Perspective viewport, drag footsteps 0 and 1 up **80** units on the Local Z-axis.

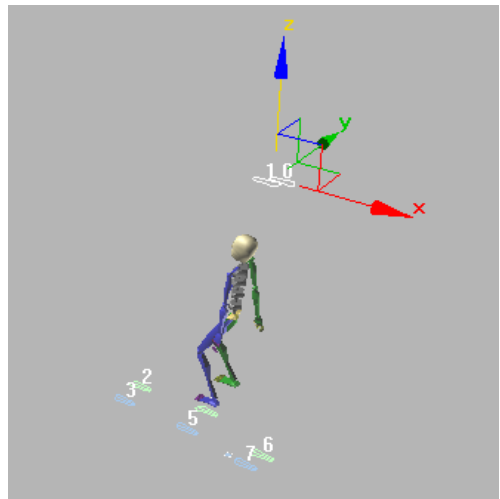

5. Select footsteps 2 and 3. Move the footsteps up **40** units on the Local Z-axis.

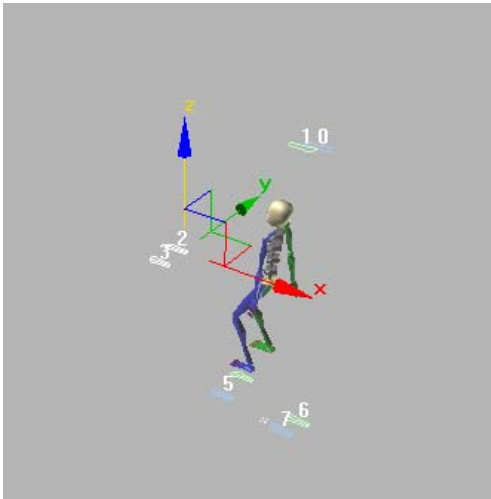

6. Select footsteps 4 and 5. Move the footsteps up **15** units on the Local Z-axis. Footsteps 6 and 7 remain at ground level.
7. Turn off Footstep mode and play the animation. The biped jumps from a height, twists, lands on a lower level, continues the jump, flips, and comes to a stop on the lowest level. The levels make the acrobatics more believable and interesting.

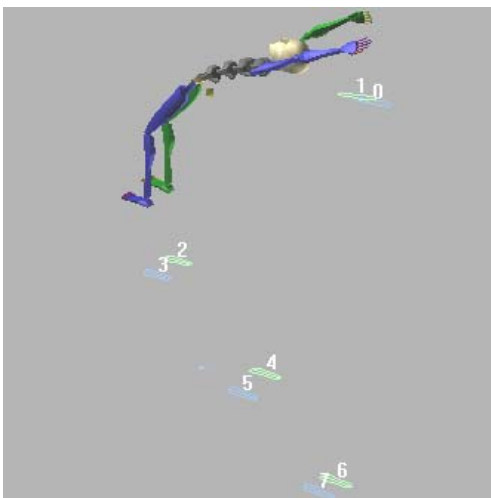

Jump and twist from a height

8.  Load *flip7.bip* if you want to verify that your motion sequence is accurate.

To add to the realism, you could create a complete scene by constructing a series of platforms under each set of footsteps.

You could also try flipping the Dr. X character.



Animating a Prtfall

In this lesson, using both Auto Key and Set Key animation methods, you'll animate a biped slipping on a virtual banana peel. You'll learn to change rigid footsteps to sliding ones, and to create a freeform period in a footstep animation using Track View. Other procedures help you to fine-tune and troubleshoot the animation.

Set up for this lesson:

1. Open *slip_start.max*.
2. Right-click the viewport name, and change the display to Wireframe.
3. Select any part of the biped.
4. Open the Motion panel.

The Biped controls are now available.

Understand the animation:

1. Play the animation by dragging the time slider.

The biped walks about 5 steps

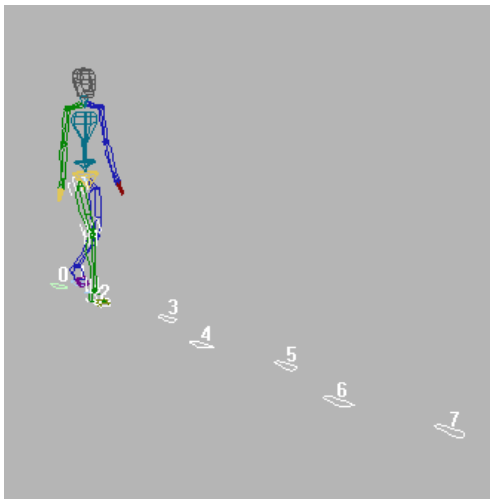

The plan is to make the biped slide and fall on footstep 5. Imagine a banana peel on that footstep.

2. Drag the time slider to frame 75, where the heel hits the ground for footstep 5. Zoom into the viewport so you can see the foot easily.
3. In the viewport, select the blue *Bip01 L Foot* object.

The pivot point displays.

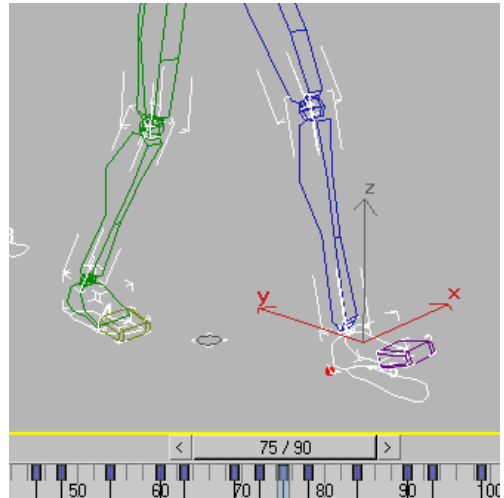

Heel touches down

4. On the Motion panel, open the Key Info rollout. Expand the IK bar so you can see IK Blend and other controls.

In the viewport, the pivot point is displayed as a red dot, and the track bar displays keys. The key for the foot at frame 75 is a planted key. This means IK Blend is set to 1, and the Join To Prev IK option is on.

IK Blend at 1 locks the pivot and the foot to the ground plane. Join To Prev IK Key considers the rotation of the foot at the previous key and attempts to match it.

5. Drag the time slider to continue to scroll through the animation, watching the pivot point move.

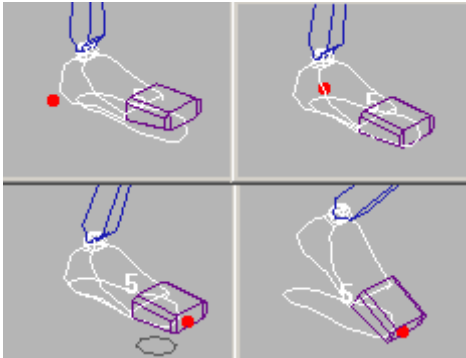



Pivot point animates over time.

- At frame 78, the pivot shifts to the outside of the heel.
- At frame 84, the pivot moves to the toes.
- At frame 93, the heel is lifting in the air. After this frame the foot is off the footstep and in the air.

Tip: In the 3ds Max status bar, turn on the Key Mode Toggle button to jump from key to key. This makes it easier to understand the animation. On the time slider, click the forward and backward arrows to move to the next or previous keys. You can also use the Next Key and Last Key buttons in the VCR Controls, or the < and > keys on the keyboard.

Create a sliding footstep:

1. Make sure the *Bip01 L Foot* object is still selected.
2.  Turn on Key mode, and go to frame 75.
3.  In the Key Info rollout, click Set Sliding Key.
4. Advance to the next key (at frame 78).
5. Rotate the foot so the toes remain up in the air.

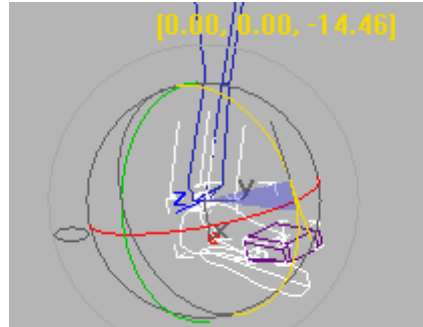

Rotated foot

6. Move the foot forward, so it slides forward on the footstep gizmo.



Sliding footstep

7.  In the Key Info rollout, click Set Sliding Key.

The pivot point jumps to the foot's new position. The footstep is now displayed with a line through it. This indicates that it's a sliding footstep: the foot can slide over or off the footstep, as well as the ground plane.

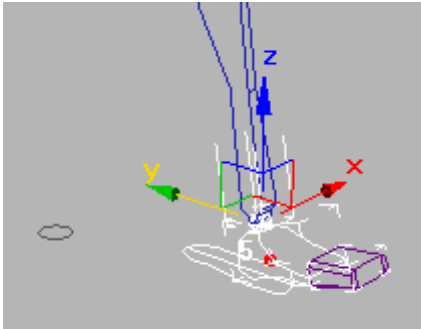

Pivot point jumps to footstep.

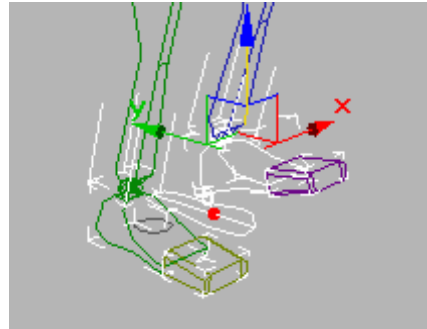

The foot rotated and raised at frame 84

8.  Advance to the next keyframe at frame 84. Set a sliding key.
9. In the Key Info rollout, in the IK group of controls, click the Select Pivot button. Then, in the viewport, click the blue pivot at the center of the back of the heel.

The pivot turns red to show it has been selected.

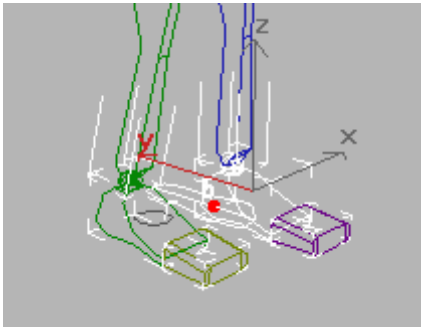

Pivot selected at back of heel

10. Turn off Select Pivot.
11. Rotate the foot, then raise it up in the air, so the foot is starting to kick upward.

12.  Set a sliding key.

Again the pivot point jumps from the footstep to the foot.

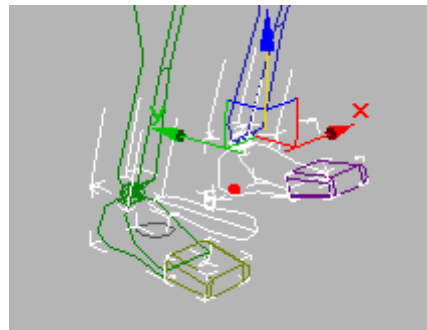

Tip: If the foot is off the footstep and in the air, use a free key. A sliding key, however, will also let you lift the foot off the footstep.

13. Move the time slider to play the animation.

The biped's left foot slides over and off footstep 5.

Next, you'll create a freeform period, so you can freely animate the biped's movement in the air.

Create a freeform period:

Using a freeform period in a footstep animation allows you to suspend the automatic systems Biped uses during footstep animation.

If you set up a freeform period between footsteps 5 and 6, you'll be able to animate the biped slipping, falling, and bouncing on the ground plane.

1. In the Biped rollout, turn on Footstep Mode.
2. Right-click in the viewport and choose Curve Editor.

Track View opens.

3. On the Track View menu bar, choose Modes > Dope Sheet.

The footstep keys are now visible in Track View.

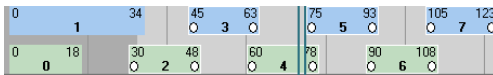

4. In Track View, double-click footstep 6.
In the viewport, footstep 6 highlights in white.
5. In Track View, move footstep 6 so it is directly under footstep 7.

This creates a gap for a freeform period.

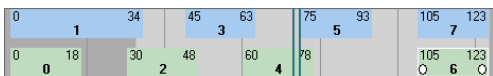

The footsteps in Track View display the starting and ending frames. As you move the footstep in Track View, these frame numbers change.

Tip: You can also change the duration of the footstep by using the Footstep Edge Selection arrows in the Footstep Mode dialog. Click the left or right arrow to select that edge for movement. Select the dot between the arrows to move the footstep in time, without changing its duration.

6. In Track View, right-click anywhere in the Footstep track.

The Bip01 Footstep Mode dialog is displayed.

7. In this dialog, turn on Edit Free Form (No Physics).

In Track View, a hollow yellow box appears to the right of footstep 5.

8. Click inside the hollow yellow box.

The box becomes solid yellow. This indicates that it's a freeform period.

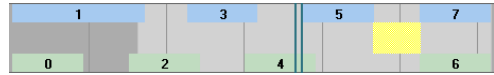

9. Scrub the time slider and watch the animation.

The biped floats from footsteps 5 to footstep 6.

Change the timing of the slip:

The slip happens too slowly. You can change the timing of the sliding footstep so the freeform period starts sooner. Also, you need more time for the body to rotate and bounce on the ground.



1. Click Time Configuration in the time controls on the 3ds Max status bar.
2. In the Time Configuration dialog, change End Time from 123 to 150. Click OK.

This extends the animation by adding 27 blank frames.

3. In the Bip01 Footstep Mode dialog, turn on Edit Footsteps

If you've closed this dialog, right-click the solid yellow freeform period in the Track View - Dope Sheet.

4. In Track View, drag a selection rectangle around footsteps 6 and 7.
5. Move footsteps 6 and 7 to the right, so the yellow period is extended and footsteps 6 and 7 start later, at frame 140.

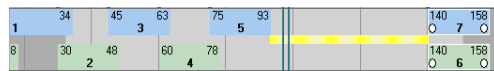

6. In Track View, notice that the last two footstep keys extend beyond the end of the animation,

into the darker gray area. To extend the animation, press **ALT+R**.

The end of the animation now matches the end of the footsteps. The time slider now shows the animation has been extended to 158 frames, as does the change in the background behind the footstep keys.

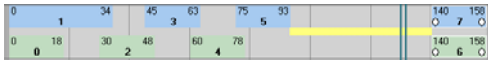

Tip: If the Biped keyboard shortcuts won't work, turn on the Keyboard Shortcut Override Toggle on the Main toolbar.

7. In Track View, click footstep 5.
8. In the Footstep Mode dialog, in the Footstep Edge Selection group, click the right arrow. A white dot appears at the right side of the box for footstep 5.



9. Adjust the right side so the footstep ends at frame 83. You'll probably need to zoom in so you can see the frame numbers. Use the Zoom button at the lower-right corner of Track View.



10. Play the animation. The biped slides faster over the footstep. Since you're still in Footstep mode, you can also move the footstep's position in the viewport.
11. In the Perspective viewport, select footstep 6 and move it next to footstep 7.

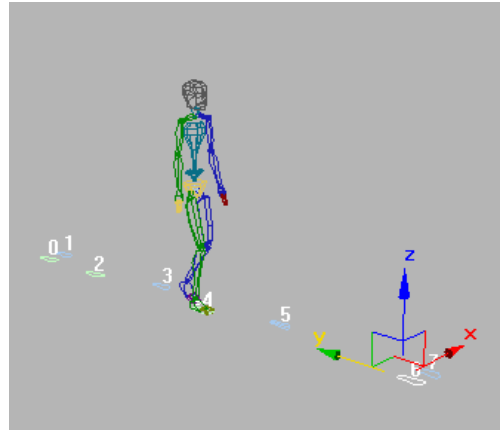

12. Move the time slider to observe the animation. Now you have enough time and space for the pratfall.

Keyframe the fall:

In this procedure, you'll turn off Dynamics Blend, so Biped physics is not used in the animation. To keyframe the fall, you'll rotate the center of mass, so the biped moves from vertical to horizontal. You'll also move the center of mass, so the biped rises up and then falls to the ground plane.

1. In the Bip01 Footstep Mode dialog, turn on Edit Free Form (No Physics). Close the Track View window.
2. Turn on Auto Key. Since the center of mass doesn't use planted, sliding, or free keys, you can use the Auto Key button to set keys automatically.
3. Turn off Footstep mode to display other Biped rollouts.
4.  In the Track Selection rollout, click the Body Vertical button.

Now you can see keys in the track bar.

5. Move the time slider to frame 78. In the Key Info rollout, click Set Key.

- In the Key Info rollout, expand the Body bar, then change Dynamics Blend to 0.

This turns off Biped Dynamics and applies Spline Dynamics instead. Biped Dynamics, available only on Body Vertical track keys, adds physics to the animation, while Spline Dynamics does not.

- Move to frame 83.

The left foot has a planted key at this frame.
- In the viewport, move the center of mass forward a little.
- Rotate the center of mass slightly (-15 degrees) so the biped begins its pratfall.

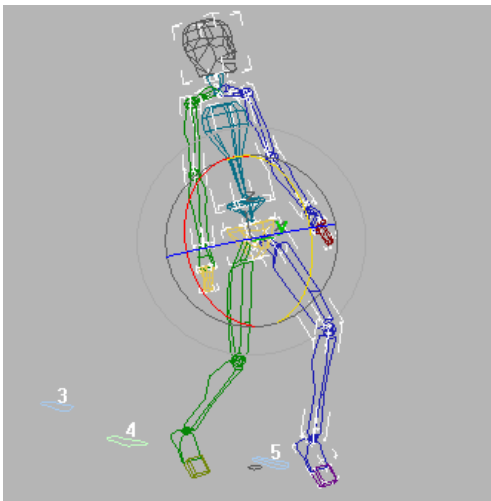

COM moved and rotated at frame 83

-  Select the blue foot. In the Key Info rollout, set a sliding key.
- Move to frame 86. In the Track Selection rollout, turn on Body Rotation.
- In the viewport, rotate the center of mass so the biped is horizontal.

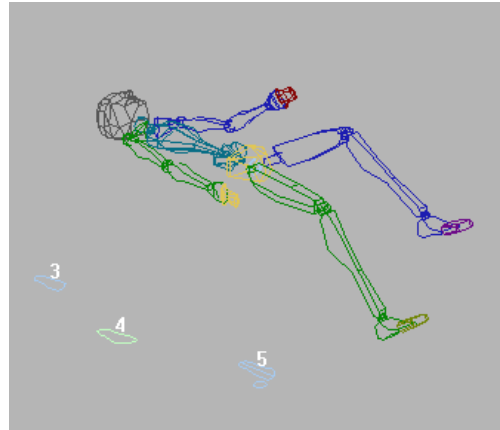

Rotation at frame 86

-  Select and move each foot so it's raised up and spread apart. After you move each foot, rotate it so it's pointing upward, then click the Set Free Key button in the Key Info rollout.

Whenever you keyframe the hands and feet, try to use the Set Key options rather than Auto Key. This gives you added control.

-  Select and move each arm so it's positioned out from the body, and then click the Set Free Key button.

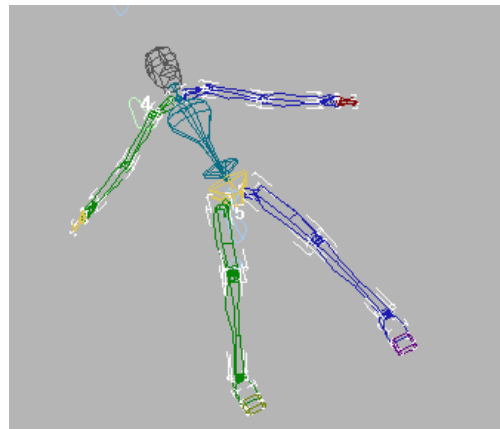

View of biped from overhead

Next, the biped's feet need to swing up for a frame or two after the rest of the biped begins to descend.

15.  Move to frame 88. Move each arm and foot up some. Rotate each leg and arm as well. Rotate the feet a little, so the toes point upward. Again, click Set Free Key after moving and rotating each object.

This adds some secondary motion to the animation.

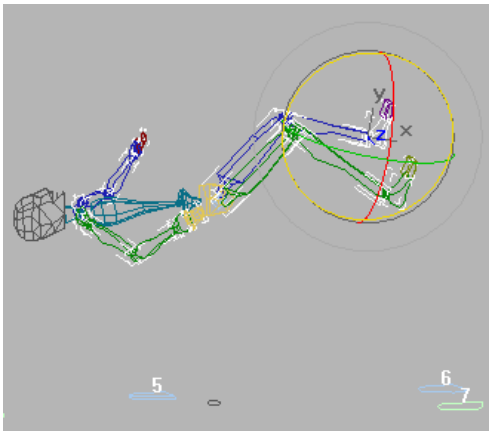

16. Move to frame 97.

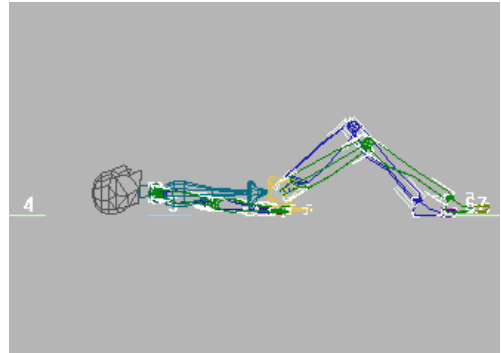

The next step creates the descent of the horizontal biped to the ground.

17. In the Track Selection rollout, turn on Body Vertical. In the viewport, move the center of mass so the biped is on the ground. Use a Left viewport to gauge the ground plane (optionally, you can create a box for this purpose). Rotate the center of mass so the biped is horizontal again.



Biped on ground plane in Left viewport

As you work, you'll notice that the green foot keeps trying to point toward the ground. This is due to the settings on the keys for footstep 7. You'll fix that next.

18.  Select the green foot, and press the > key to move to the next keyframe. In the Key Info rollout, click Set Free key. Repeat for all the remaining keys from here to frame 158.
19. Correct any foot rotations that still seem out of place, setting free keys for them as you do.
20.  At frame 97, position the feet so they are flat on the ground. Click Set Free Key for each foot. Rotate the hands so they are flat on the ground as well, and again click Set Free Key for each.
21. Use the time slider to flip through the biped's slipping motion. Notice that the biped magically rises up after the fall; you'll change that later in the lesson.

Next, you'll add a slight bounce to the body.

Add a bounce:

You'll add keyframes to make the biped strike the ground and bounce once. There's a Body Vertical key set at frame 111 you need to reset.

1.  In the Track Selection rollout, turn on Body Vertical. Move the time slider to frame 111.
2. In the Key Info rollout, expand the IK bar, and change Dynamic Blend to 0.

Note: If Dynamic Blend is unavailable, click Set Key first. Dynamic Blend is only available where there are Body Vertical keys.

3. Rotate the biped so it's horizontal.
4. Move the biped back down to the ground.
5. At frame 101, keyframe the center of mass so the biped lifts off the ground.

Optionally, add secondary movement by keyframing the hands to trail the movement of the center of mass.

6. A few frames after the center of mass lifts off, raise the hands.
7. A few frames after the center of mass strikes the ground, make the hands and feet strike the ground. You can set planted keys for the hands and feet.

Next, you'll keyframe the spine. This biped only has two spine links, so it's easy to do.

8. At frames 95 and 110, rotate the spine so the shoulders touch the ground .

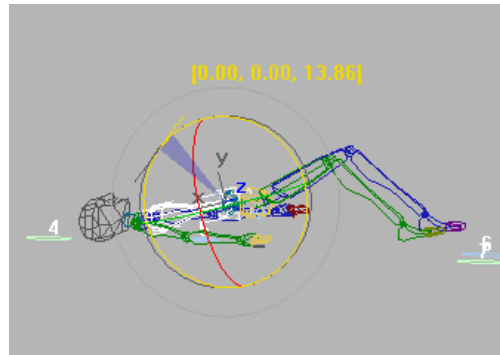

Spine rotated so shoulders touch ground

Next , you'll keyframe the head.

9. At frame 95, rotate the head so the chin tucks in. At frame 102, rotate again so the head rocks back.

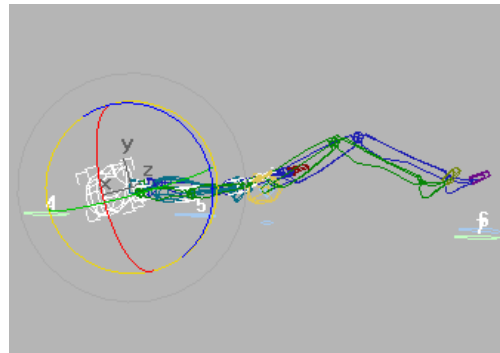

Head rotated

10. At frame 97, in the Track Selection rollout, turn on the Body Rotation button.
11. In the Key Info rollout, expand the TCB bar. Change both Tension and Continuity to 0. This sharpens the bounce, as shown in the curve diagram.

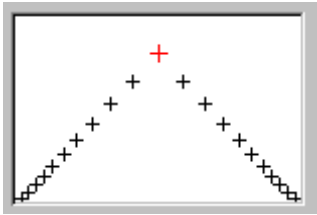

Tension and Continuity at zero

Tip: If the Tension and Continuity curves are not available, click Previous key, then Next key to return to this keyframe with the curves displayed.

12. Play the animation.

The biped bounces more crisply.

- 13.** Create a box under the area of the slip and use it to gauge if you need to raise any part of the biped that sinks into the floor. If you turn off Wireframe viewport shading, you'll be able to visualize the intersection of the biped and box more clearly.

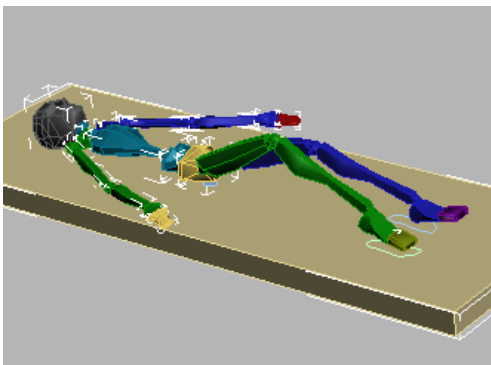

- 14.** Save your work as **myslip.bip**. Compare your work to *slip_with_box.bip*.

As noted earlier, the biped miraculously stands back up when the animation finishes. This is a consequence of the last footsteps. Since 3ds Max lets you change back and forth between footstep and freeform modes, you'll convert between animation modes to correct this.

Convert from footstep to freeform:

You can convert between the footstep and freeform modes without any loss of motion. The motions remain identical (within some limitations), whether you convert from footstep to freeform, or freeform to footstep.

1. Continue in the current file, or open *slip_convert_start.max*.
2. Turn on Auto Key.
3. In the viewport, select any biped body part.
4. On the Motion panel, in the Track Selection rollout, click either Body Horizontal, Body Vertical, or Body Rotation.



5. In the Piped rollout, choose Convert.
6. In the Convert To Freeform dialog, click OK. Do not turn on "Generate a keyframe per frame".

The footsteps disappear from the viewport, but the animation is the same as before.

Next, you'll delete the keys that raise the biped back to standing position.

7. At frame 111, select the entire biped.
8. In the track bar, select all the keys after frame 111.



9. Delete all the selected keys.

Now play the animation. The biped walks, slips quickly, and then lays completely still.

Change the timing:

1.  Be sure Auto Key is still on.
2. Select the entire biped.
3. In the track bar, drag a box to select all the keys from frame 86 to the end of the animation.
4. Move the time slider to frame 90.

- Slide all the keys down, so the keys from frame 86 are now at frame 90.

Tip: To move keyframes to a precise location, first select the keys. Then move the time slider to the desired location, and then move the keys.

The pratfall lasts a little longer now.

If you like, you can add some more rotations to the head after frame 115. While the biped is laying on the ground, make his head shake with disbelief. Also try keyframing some small movements in the feet, placing the feet flat on the ground and sliding them toward the pelvis, raising the knees. Put planted keys on the hands and feet, then rotate the COM for an interesting effect.

- Save your work as *myslip.max*, or load *slip_final.bip* to see the results.

Changing Footsteps Using IK Keys

Footstep and Freeform modes both use the same underlying inverse kinematics (IK) to animate the biped skeleton. Footstep gizmos are a method for manipulating sequences of IK keys.

In this lesson, you'll learn how making changes to the IK keys affects the footsteps.

Set up for this lesson:

- Open *footsteps_keys_start.max*.

A biped is displayed with four footsteps in the viewport.

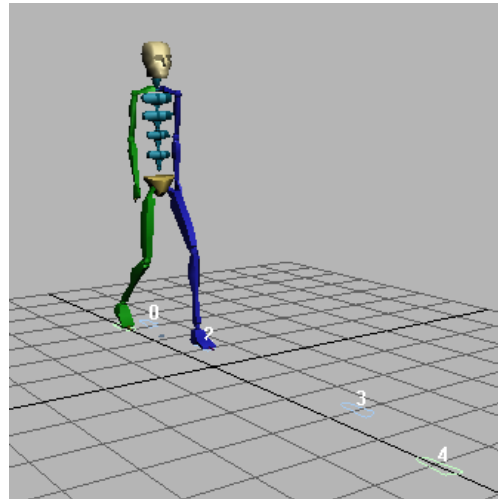

Set IK Keys to create footsteps:

- Drag the time slider to play the animation.

The biped hops on his right foot. Notice that there is no footstep for the right foot between footsteps 2 and 3.

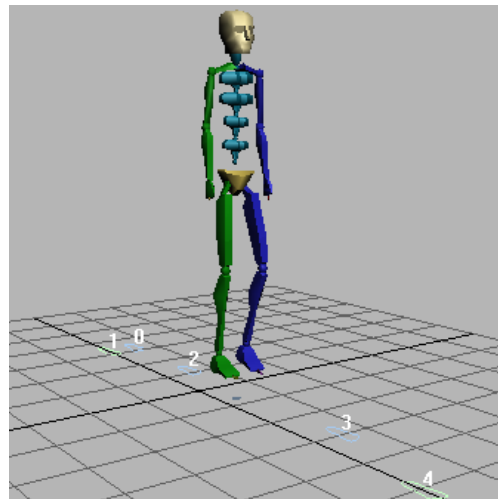



- At frame 45, select *Bip01 R Foot*.

-  In the Key Info rollout on the Motion panel, click Set Planted Key.

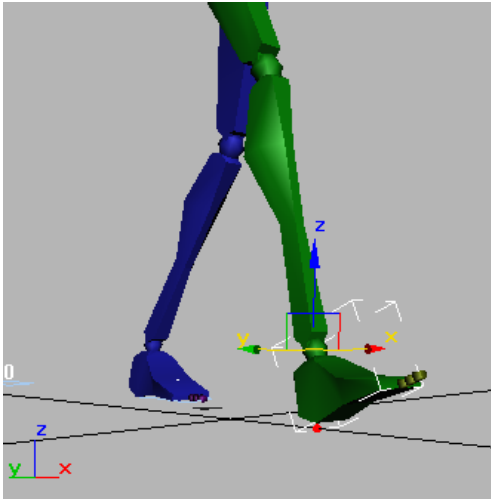
The pivot point is displayed in the viewport. If you can't see it, change to Wireframe viewport shading, or navigate the viewport so you can see beneath the heel.



4.  On the 3ds Max status bar, turn on Key Mode Toggle.
5.  Click next key to go to frame 48, and then click Set Planted Key.

The pivot point shifts to the toe.

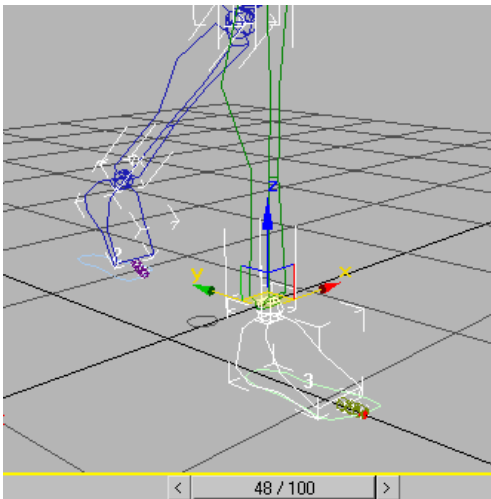

Note that the lowest IK pivot is selected by default for cases where IK is applied to new keys.

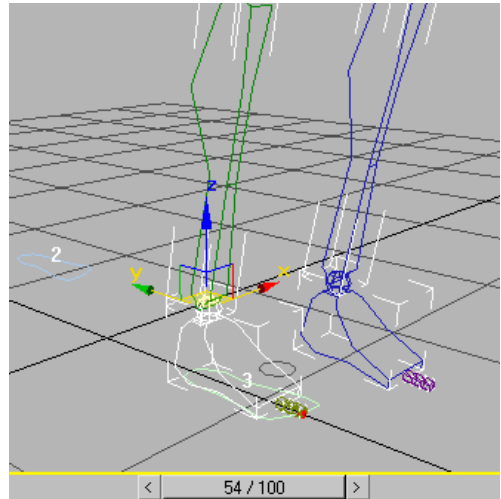

6.  At frame 54, click Set Planted Key.



The biped is moved back to the ground. A footstep is displayed beneath the biped's foot.

A footstep has been created, because there is now an interval of time where IK is applied between the two planted IK keys. However, if you drag the time slider to play the animation, you will see that the walk still needs work.

Change the duration of footsteps using IK keys:

1.  At frame 60, click Set Planted Key.
2. Play the animation now. The walk cycle is much better.
3. Right-click on the foot and choose Dope Sheet.
4.  On the Dope Sheet tool bar, turn on Edit Keys if it is not on already.
5.  In the Biped rollout, turn on Footstep Mode to easily locate the track in Dope Sheet.

- Expand the Footsteps track and notice that footstep 3 extends for 15 frames, from frames 45 to frame 60.



- Turn off Footstep Mode.

- Select *Bip01 R Foot*.

The keys for the foot are displayed in the Dope Sheet



- At frame 63, set another planted key.



- Turn on Footstep Mode.

The Dope Sheet editor again displays the Footsteps track.

The duration of the footstep now is 18 frames, from frames 45 to 63.

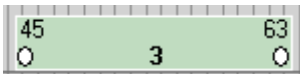

- Turn off Footstep Mode.

Remove footsteps using IK keys:



- At frame 45, select the Bip01 R Foot object in the viewport, then set a free key.



- At frame 48, set a free key.



- At frame 54, set a free key.

Note: The body vertical position is modified. The biped now floats up into the air at frame 54.



- At frame 60, set a free key.

The footstep disappears.

There is only one IK key left. With no IK interval defined, there is no duration, and therefore no footstep.

The animation could be made more realistic by adding arm movement to the hopping steps, or by creating a freeform period for the hop, then

adding poses for a crouch, spring and landing. The point of this lesson, however, has been to demonstrate that footsteps can actually be created or removed by changing the IK keys.

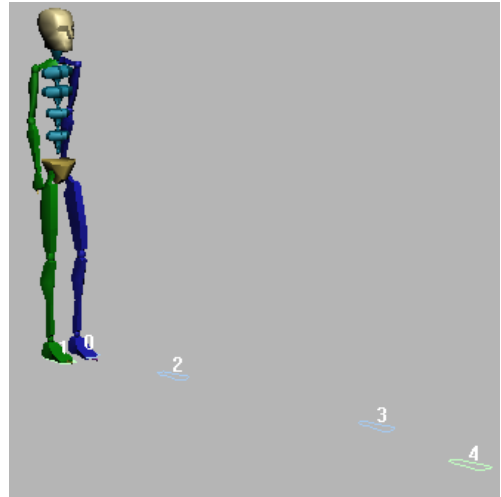

Summary

In this tutorial, you learned how to animate a biped using footsteps, and make a biped, walk, run, do flips, jump, and take a fall. You also learned how to add a freeform period to a footstep animation, convert a footstep animation to freeform animation, and change the duration of a footstep animation using IK keys.

Animating with Freeform

This tutorial shows you how to animate a biped using the freeform technique. This method does not use footsteps; instead, you are responsible for animating every part of the biped. Freeform animation gives an animator fine control over the biped's motion.



In this tutorial, you'll learn how to:

- Create a simple animation of a biped swimming in place
- Use planted, sliding, and free keys
- Create a traditional walk cycle using animated pivot points
- Create a stretchy leg and a shaky walk using Biped SubAnim controllers
- Create animated 3ds Max bones from a biped animation

Skill level: Beginner to Intermediate

Time to complete: 2 hours

You can find the files for this tutorial in the *tutorials\character_animation\freeform_animation* folder on the Tutorial Files CD that ships with 3ds Max. Before starting the tutorials, copy the *tutorials* folder from the CD to your *13dsmax8* local installation.

Creating a Simple Freeform Animation

This tutorial is an introduction to using freeform animation techniques with Biped.

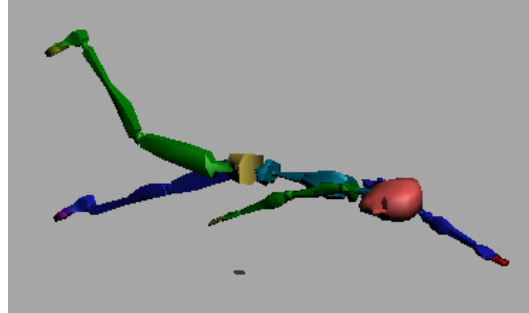

In this tutorial, you will animate a biped swimming in place. You'll use freeform animation methods to produce the kicking legs and arm strokes.

In order to create this motion, you'll use a combination of rotations and moves. You'll also make use of Copy and Paste Posture Opposite to animate one arm and copy its tracks to the other.

Note: The illustrations and steps below were created using the World coordinate system.

Set up the lesson:

1. Reset 3ds Max.

2.  From the Create panel, click the Systems button.

Create a biped and load a FIG file:

1.  Click the Biped button and create a biped in the Front viewport.

2.  Open the Motion panel.

3.  Turn on Figure Mode and click Load File.

The Open dialog displays.

4. Open the file *cs4_tut_rtggame.fig*.

The biped takes on new structural elements saved in the FIG file. This simplified figure has one large toe on each foot and one large finger

on each hand; its spine contains two segments instead of four.



The biped with FIG file applied

5.  Turn off Figure mode.

Tip: You cannot animate in Figure mode.

6.  Select all the biped objects, then click Zoom Extents All.
7. Save the scene as **MySwimmer01.max**.

Start a freeform animation:

You start a freeform animation by clicking the Auto Key button and transforming any part of the biped.

1. Right-click in the Left viewport.
This activates the Left viewport and does not affect selected objects in the scene.
2. Press **ALT+W** to maximize the viewport for a closer view of the biped.

The biped should be in wireframe. Change the shading display of the Left viewport if it is not wireframe.

3.  Turn on Auto Key.

The button turns red, and the active viewport is outlined in red.

4.  From the Track Selection rollout on the Motion panel, click Body Rotation.

Tip: The center of mass object is automatically selected when the movement and rotation buttons in the Track Selection rollout are used.

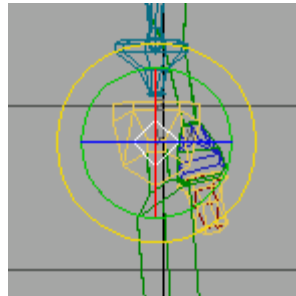

Rotation transform gizmo

The rotation transform gizmo lets you easily rotate an object about a chosen axis. As you move your cursor over the gizmo in the viewport, the axis circles will turn yellow indicating which axis the rotation will occur around.

Note:

- The red circle, displayed as a vertical line in this viewport, affects the X-axis.
 - The green circle affects the Y-axis.
 - The blue circle, displayed as a horizontal line in this viewport, affects the Z-axis.
 - The light gray circle, displayed around the green circle, allows free rotation around all three axes.
5. Move your cursor over the green circle.

The cursor changes to yellow, meaning that any rotation is locked to that axis

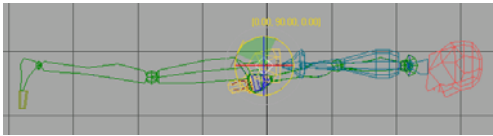

- Rotate the center of mass approximately **90** degrees about the Y-axis. Watch the coordinate readout near the gizmo to see how far you're rotating the biped. Rotate until the biped is lying prone.

Tip: Press **A** on the keyboard to turn on Angle Snap to easily rotate to 90 degrees.



An animation key appears at the far left of the track bar, at frame 0.

You can select all three COM tracks under Track Selection to create keyframes simultaneously. Try this:

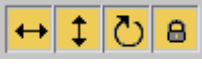
-  In the Track Selection Rollout click on both the Body Horizontal and Body Vertical tracks so that both tracks are selected.
-  Expand the Key Info rollout and click Set Key.
-  In the Track Selection Rollout click Lock COM Keying, then click the Body Rotation button.
  All the multiple tracks for the COM are now selected at once.
- In the Key Info rollout, click Set Key again, and you can set a key for all the COM tracks at frame 0.

The trackbar key shows a multi-color display indicating that both position and rotation keys have been created.

- Click the Lock COM Selection to unlock the COM tracks, then click the Body Rotation again to return to the previous state.

Tip: It's a good idea to set a key at the start of your animation for the 3 COM tracks.

Pose one leg:

Now that the biped is prone, you're ready to animate the swimming motion. First, you'll position the legs. You'll work on the right leg first, setting up its position at frame 0.

- Press **ALT+W** so you can see all four viewports again.
- Select *Bip01 R Thigh* by clicking the lines of the thigh in the Left viewport.

Tip: As you hold your cursor over an object in the viewport, the object's name is displayed in a tooltip, or you can press the **H** key to choose objects from the selection list.



The right thigh is selected.

- Rotate *Bip01 R Thigh* approximately **-30** degrees about the Z-axis.

The right leg is rotated, but the right foot is pointing straight down.

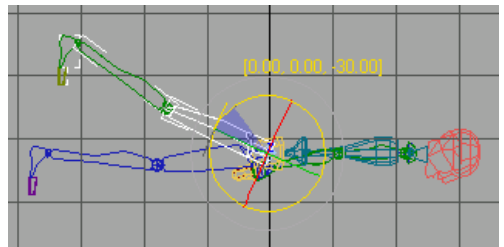

- Click PAGE DOWN twice to select the right foot.

Tip: The PAGE UP and PAGE DOWN keys are a quick way to navigate through the objects that make up a biped.

- Rotate *Bip01 R Foot* about -50 degrees around the Z-axis.

The foot looks better in this position.

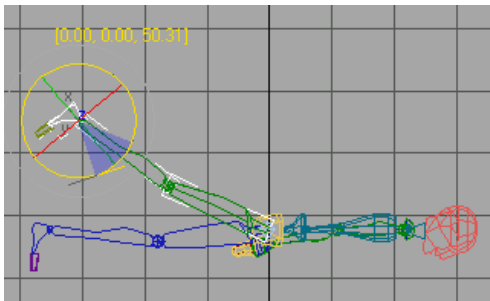

In these rotations, you've just used 3ds Max "forward kinematics." Next you'll use the Select And Move tool on the foot to move the entire leg.

- Right-click the same foot and select Move from the quad menu.

Tip: You can choose the transform tools either from the Main toolbar or by right-clicking to open the quad menu.

The Transform gizmo switches to an axis tripod showing two of three arrows in this viewport. They are displayed at right angles with the Z-axis pointing up and the Y-axis pointing left.

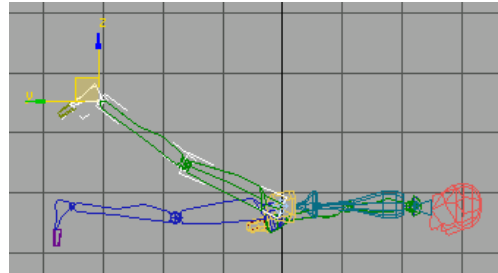

Ready to move the foot

- In the Left viewport, move the cursor over the Y-axis of the gizmo until it turns yellow, then move the foot a little to the right.

The knee bends to accommodate the new position of the foot.

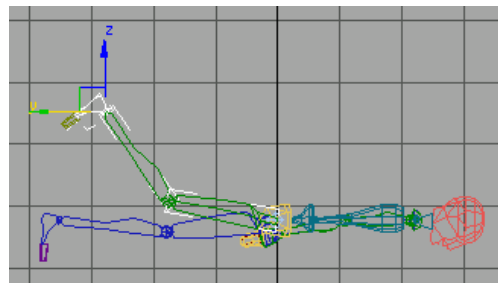

The knee bends

In this move, you've just used "inverse kinematics." The foot, calf, and thigh are linked together in a hierarchical chain. By moving the end of the chain, the foot, you rotated the lower and upper leg objects.

- Save the scene as **MySwimmer02.max**.

Animate the leg:

Everything you've done so far has been at frame 0. Now you'll move forward in time and animate the pose at frame 10.

- Move the time slider to frame 10.
- Move the foot down in the Z-axis until the knee straightens out.

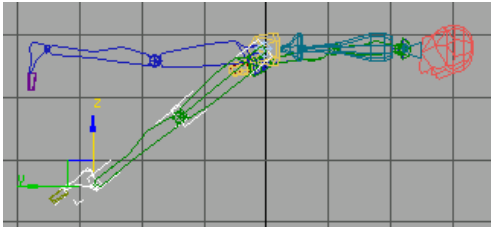

3. Press PAGE UP twice to select *Bip01 R Thigh*.
4. Right-click and choose Rotate from the quad menu, then rotate the *Bip01 R Thigh* approximately -10 degrees about the Z-axis.

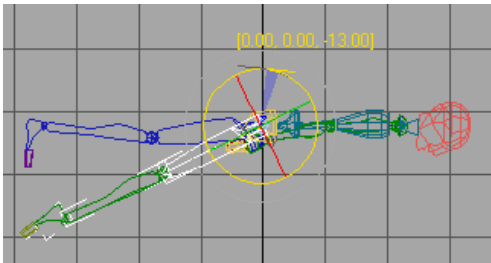

Rotating the thigh

5. Move the time slider back and forth between frame 0 and frame 10.

The leg moves up and down.

Use copy and paste:

Now you'll use some specialized Biped tools to pose and animate the opposite leg.

1. Return the time slider to frame 10.
2. Double-click *Bip01 R Thigh*.

The entire leg is selected from the thigh down to the toes.

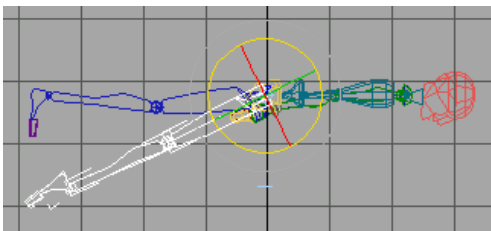

3. From the Motion panel, open the Copy/Paste rollout.

The Copy/Paste functionality includes the creation of Collections. You must first create a Collection before you can start creating Postures.

4.  In the Copy/Paste rollout click the Create Collection button. This creates a collection named Col1. Rename this to Swim - Crawl.
5. Make sure Posture is turned on.



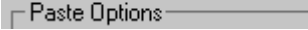

6.  Paste Options Also make sure that Capture Snapshot from Viewport is turned on just above the Paste Options group. This forces the thumbnail of the pose to be taken from the active viewport. This particular posture, for example, is better seen from the left rather than the front viewport.

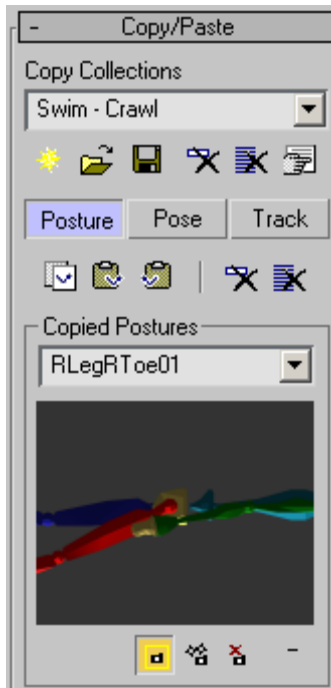
7.  Click Copy Posture.



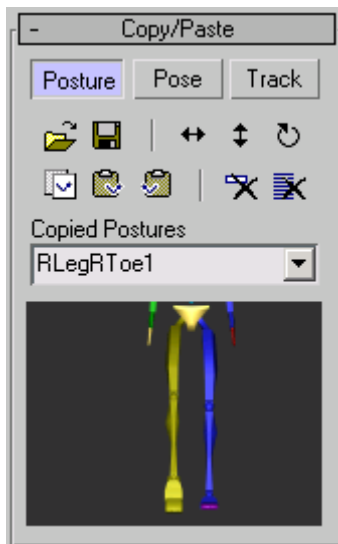

The posture of the right leg is copied into a buffer. Change the name of the Copied Posture to RLegRToe01 – downkick.

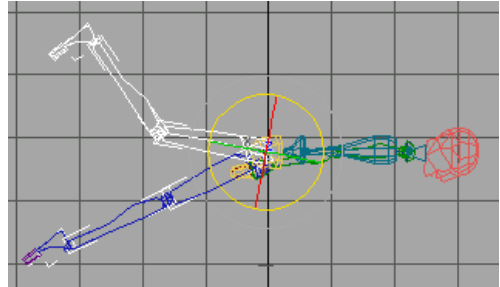

8.  Move the time slider back to frame 0. Choose Paste Posture Opposite. The left leg rotates downward. The right leg hierarchy is still selected.



9.  At frame 0, choose Copy Posture again.
10. Move the time slider to frame 10.
11.  Click Paste Posture Opposite again.

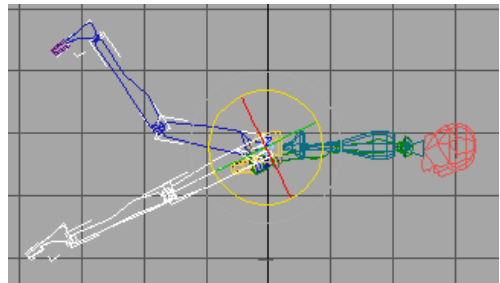

Now the left leg is raised, and the right leg is down.





12. Move the time slider back and forth between frames 0 and 10 and watch the legs kick. Now you'll repeat this process to make the legs kick several times.
13. Save the scene as **MySwimmer03.max**.

Use Paste Posture to create multiple kicks:

You can use the Copy Posture tools to quickly duplicate all the leg keys from one frame to another to create repeated kicking motions.

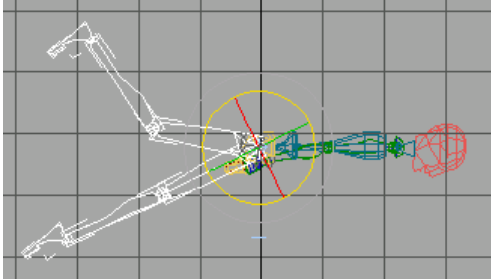
1.  Make sure Auto Key is still on and move the time slider to frame 0.
2.  On the Track Selection rollout, choose Symmetrical.
Now both legs are selected.



3.  Click Copy Posture at frame 0. Name the copied posture *R up L down*.

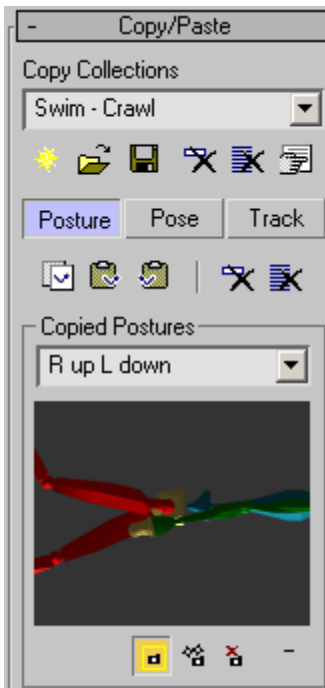

Both legs are added to the collection.

4. Move the time slider to frame 20.

Tip: You can type in the frame number in the Current Frame time control.

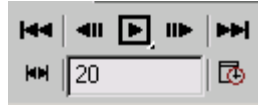

5.  At frame 20, click Paste Posture .
6. Go to frame 30 and click Paste Posture Opposite. From this point forward you can choose to either Paste or Paste Opposite as you create a kicking cycle. For a smooth kick cycle, simply alternate the posture every 10 frames up to frame 80. The track bar displays a total of nine keys for the animation of the legs.
7. In the Copy Collections group click the Save button to save your collection. Name the collection Swim – Crawl. The CPY extension is automatically added to the name.
8. Save the scene as **MySwimmer04.max**.

Tip: If you have AutoBackup turned on, the software will automatically save your work at regular intervals to the \autoback\ folder in your 3dsmax root directory.

Animate one arm:

Animating a kicking leg was fairly easy, requiring only two poses: one with the leg up, and one with the leg down. Animating the arms is more complex. To animate the stroke of an arm, you'll need five poses:

- The arm outstretched
- The arm down
- The arm back
- The arm drawn up out of the water near the ear
- The arm entering the water

When one arm is animated correctly, you'll use Copy Track and Paste Opposite Track to animate

the second arm. You'll adjust the timing of the second arm by sliding the keys in the track bar.

1.  Make sure Auto Key is still on and move the time slider to frame 0.
2. Press H and select *Bip01 L UpperArm* from the Select Objects dialog.

3.  In the Left viewport, select and rotate *Bip01 L UpperArm* approximately -160 degrees about the Z-axis, until it is extended in front of the biped.

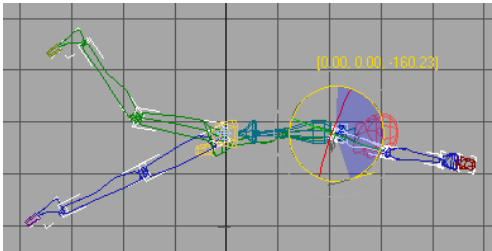

4. Right-click in the Top viewport and press PAGE UP to select *Bip01 L Clavicle* and rotate it -20 degrees about the Y-axis.

This should prevent the arm from passing through the head.

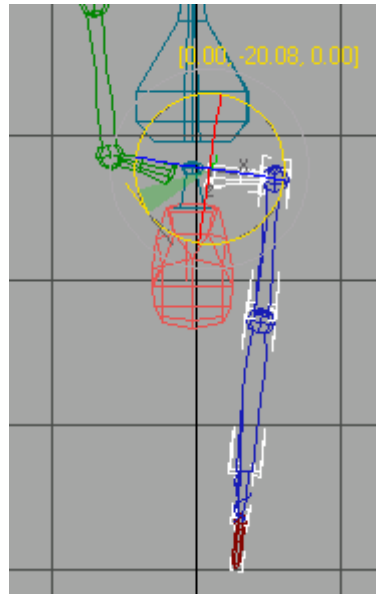

5. In the same viewport, press PAGE DOWN three times to select *Bip01 L Hand*. Rotate it approximately -90 degrees about the X-axis so the palm is facing down.

This completes the first arm pose.

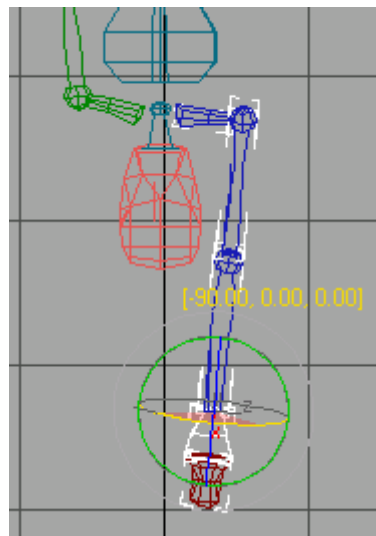

6. This completes the first arm pose. Let's save it.

7. Double-click the Bip01 LClavicle to select the entire left arm hierarchy
8. Activate the perspective viewport so that the snapshot will be easier to identify, and then choose Copy Posture. Name the pose LArm extended.

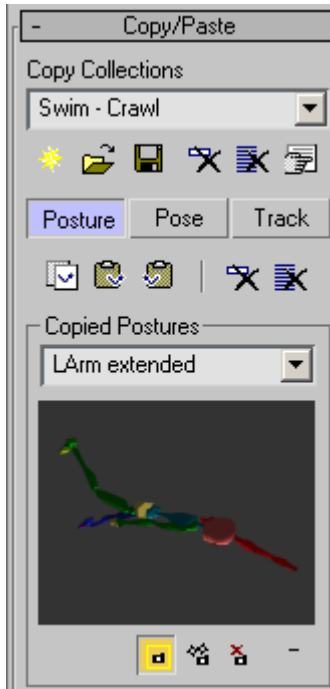

Thumbnail snapshot from perspective viewport.

9. Move the time slider to frame 10.
10.  On the Main toolbar, choose Select And Move, then change the Reference Coordinate System to World, if it's not already set.

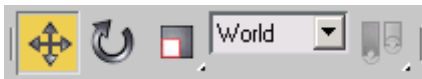

This will facilitate working with the Transform gizmo in different viewports.

11. Right-click in the Left viewport. Move *Bip01 L Hand* down on the Z-axis and back on the Y-axis until it points straight down.

This completes the second arm pose. Double-click the Bip01 LUpperArm to select the arm hierarchy and then click Copy Posture. Name the pose LArm down.

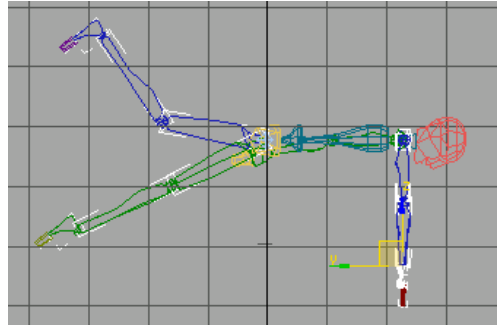

Tip: If you grab the Move gizmo by the corner where the two axes meet, you can move selected objects in both axes at once.

12. Move the time slider to frame 20.
13.  Press PAGE DOWN three times to select *Bip01 L Hand*. Move the hand along the Y-axis toward the legs.

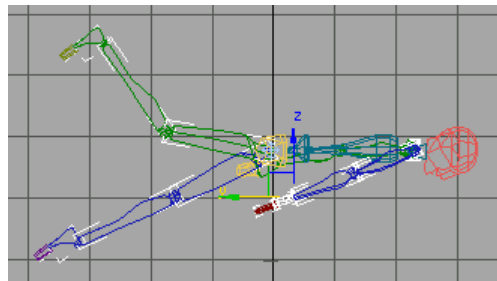

14.  Activate the Front viewport and press PAGE UP three times to select *Bip01 L Clavicle*. Rotate this part about 24 degrees around the Z-axis.

Tip: Right-click and choose the Rotate Settings box, then you can type in the transform amount of the rotation.

This completes the third arm pose. Save it by double-clicking the *Bip01 L Upper arm* in the top view to select the hierarchy, then choose Copy Posture. Name the pose *LArm back*. If you activate the Perspective viewport before you copy the posture, you can adjust the viewport so the pose is clearly visible in the thumbnail.

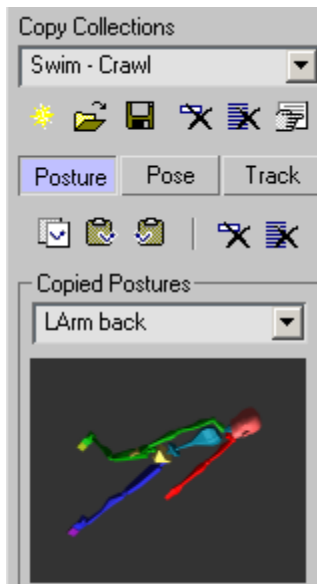

15. Move the time slider to frame 30.

16. Activate the Top viewport.



17. Press PAGE DOWN three times to select *Bip01 L Hand*. Move the hand in the X and Y axes until the hand is level with the shoulder.

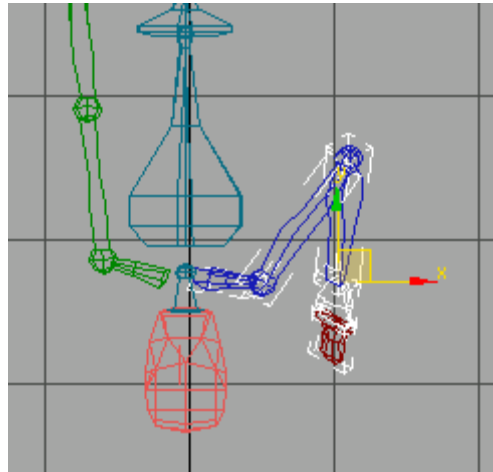

18. In the Left viewport, move *Bip01 L Hand* along the Z-axis so it is near the ear.

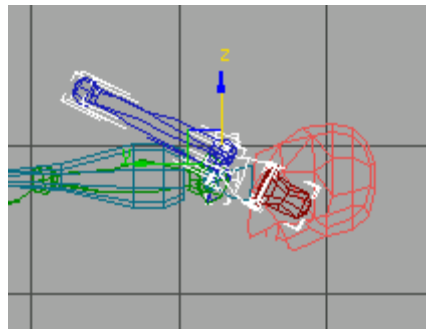

19. Finally, rotate *Bip01 L Hand* about the X-axis so the palm is flat.

This completes the fourth arm pose. Save it to the Collection by double-clicking the upper arm to select the entire hierarchy, then choose Copy Posture. Name it *LArm-up*.

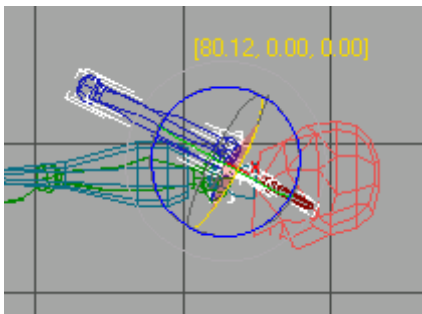
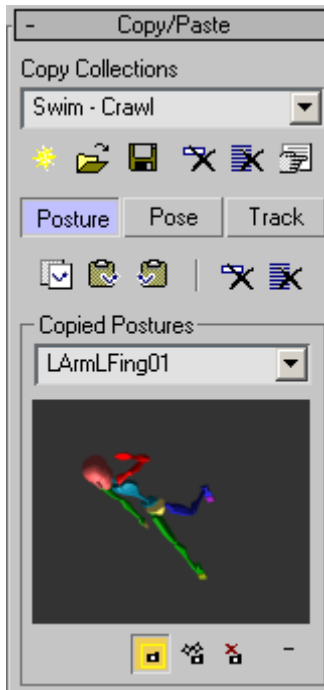

20. To create the fifth pose go to frame 37.

21. In the Left Viewport move the Bip01L Hand object on the Y-axis so it is in front of the head, and is level with the shoulders. Double-click the Bip01 L Upperarm to select the entire arm hierarchy, activate the Perspective viewport and then choose Copy Posture. Name the posture LArm stroke.

Note: The fifth pose is used to ensure that the rotation of the arm is correct going from the out of water pose to the extended pose.

22. Save the scene as **MySwimmer05.max**.

Applying a twist pose:

Twist poses can be used to correct upper arm rotations. Twist poses are primarily used to correct arm twisting, but in this case we'll use it to simply position the arm efficiently.

1. Turn off Auto-Key if it is on.
2. Select the Bip01 L Upperarm.
3. Move the timeslider to frame 33.
4. Expand the Twist Poses Rollout.
5. In the dropdown Twist Pose List, choose each pose and observe the change to the arm in the viewport. Consider the five default poses the same as additional copied postures that can be used to "straighten out" problems by defaulting to fixed rotations.

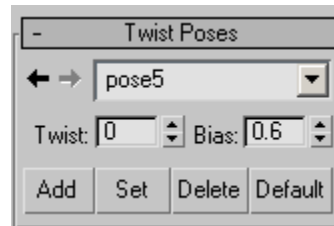

Twist Poses

6. When pose 5 is selected the arm will be rotated and positioned correctly. Expand the Key Info rollout and click Set Key to keyframe the twist pose



Default Twist pose 5

Tip: Twist poses are really designed to help you fix twisting that occurs in the mesh attached to the biped. If you go to Figure Mode, you can enable Twist Links by turning on the Twists checkbox, then set the number of Twist links you would like for the upper arm, forearm, thigh, calf or “horse-link” (the extra link in the Leg if Leg Links are set to 4). Unfreeze and Unhide all and you will be able to see the twist bones that have been added using this method. Once Twist Links are enabled you can play with the Twist and Bias settings.

Copy the Arm pose:

To complete the arm cycle in the next few steps, you'll copy the arm pose from frame 40.

1.  Make sure Auto Key is still on.
2. In the Top viewport, double-click *Bip01 L Clavicle* to select the entire left arm.

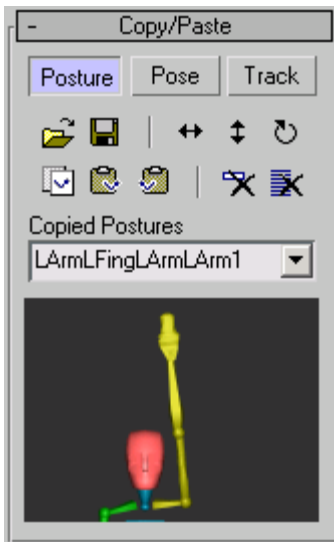

3.  Advance the time slider to frame 40 and click Paste Posture.

If you see any unusual rotations or out-of-place movements, you can set additional keys to refine the animation.

4. Move the time slider and watch the animation.

Repeat the animation:

If the animation is going to be 80 frames in length, you'll need to repeat the arm movement.

1. Double-click *Bip01 L Clavicle*, to select the entire left arm, if it's not already selected.
2. In the trackbar drag a selection window around the keys for frames 10 – 40.
3. Hold down the SHIFT key and copy these keys by dragging them to the right. When the first key is over frame 50, release the mouse button.
4. Play the animation. The biped should perform two complete strokes with its left arm.
5. Save your scene as **MySwimmer07.max**.

Add rotation to the spine:

Next you'll add some rotations for the spine to make the animation more convincing. This biped figure (*cs4_tut_rtgame.fig*), only has a two-segment spine. You'll rotate the large section representing the upper torso.

1. Make sure Auto Key is still on.
2. Select *Bip01 Spine1*.

Note: The first spine object is *Bip01 Spine*. The large second spine object is *Bip01 Spine1*.

3. Right-click in the Front viewport.
4. Move the time slider to frame 10 and rotate *Bip01 Spine1* approximately –15 degrees about the X-axis.

This will create the appearance that the body follows the movement of the arm.

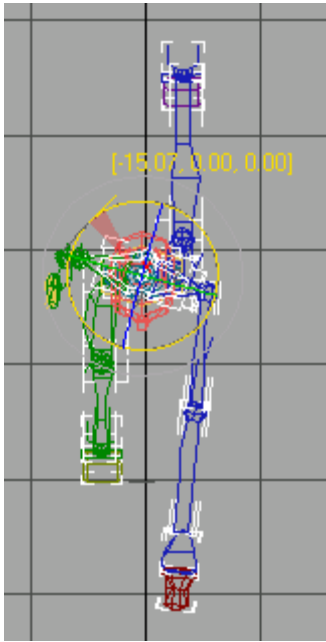

Spine rotation

5. Move the time slider to frame 0 and rotate *Bip01 Spine1* 15 degrees about the X-axis. This sets a start key for the rotation.
6. In the track bar, click the key at frame 0 to select it, then hold down the SHIFT key and drag a copy to frame 30. Watch the status area to know when you are at frame 30.



The spine now rotates once in the 40-frame cycle.

7. Select the *Bip01 Pelvis*.
8. Move the timeslider to frame 10 and rotate the pelvis a few degrees in X so it follows the movement of the left leg.

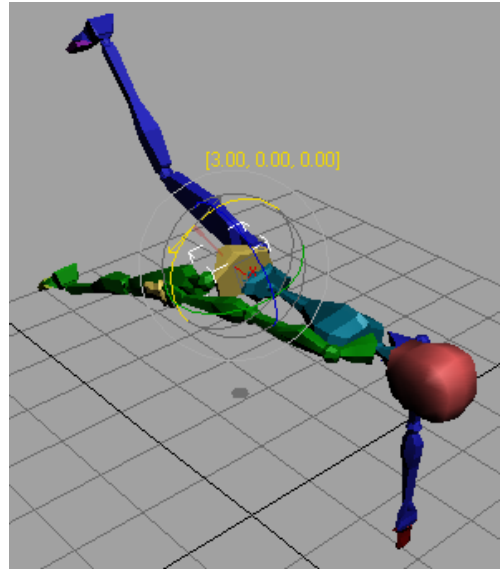

Rotate the Pelvis

9. Move the timeslider back to frame 0 and rotate the pelvis -3 degrees around the X axis to key frame it.
10. Repeat for frames 20 and 30.

Tip: You can also add a few degrees of rotation around the Y axis as well for the pelvis if you like.

Next you'll copy the pelvis and spine rotation keys to repeat the motion.
11. Move the time slider to frame 40.
12. Make sure the pelvis is still selected, then hold down the CTRL key and click on the *Bip01 Spine01* object (the large torso spine object).
- 13.
14. In the track bar, drag a selection rectangle around the three visible keys.
15. Hold down the SHIFT key and drag the keys so the leftmost key is copied to frame 40. Move the time slider back and forth to see the animation.
16. Copy the key from frame 0 to frame 80 to complete the set of keys.



The final set of Bip01 Spine1 keys

Animate the head:

The biped can breathe while he swims, if you rotate the head appropriately.

1. In the Left viewport, select the biped's head, *Bip01 Head*.
2. Move the time slider to frame 0 and rotate the head about **70** degrees around the X-axis, so the biped's left ear is pointing down.

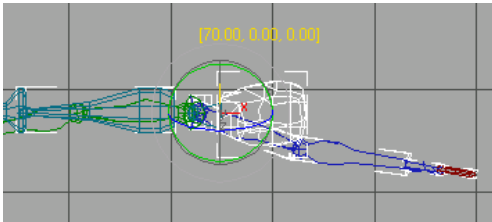

Rotate the head for breathing motion.

Tip: Watch the Perspective viewport while rotating in the Left viewport.

3. At frame 20, rotate the head back down.

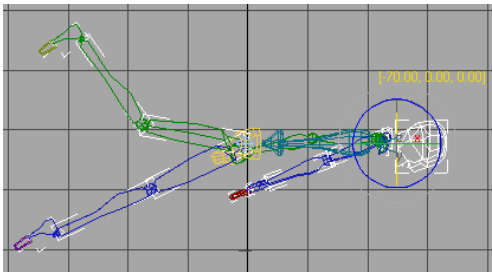

4. Hold down the SHIFT key and drag to copy the key at frame 0 to frame 40. Watch the status area to know when you are at frame 40.
5. Move the time slider to observe the head rotation.

Actually, it would look better if the head were turned up at frame 30.

6. Slide the key you made at frame 20 along the timeline to frame 30. Do not hold down the SHIFT key for this step.

The biped lifts and lowers its head once in the 40 frame cycle.

Tip: You can move the time slider to frame 30, then slide the key on top of it.

7. To explore another way to copy keys, right-click the time slider.

The Create Key dialog is displayed. This lets you create keys by choosing a source and a destination.

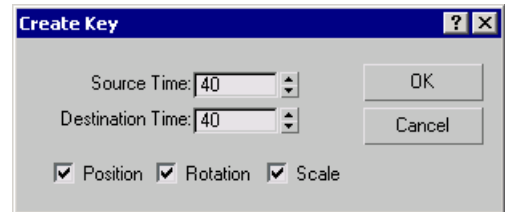

Tip: You don't have to turn on Auto Key, to set keys this way.



8. Set the Source Time to 30 and the Destination Time to 70, then click OK.
9. Right-click the time slider again.
10. Set the Source Time to 0 and the Destination Time to 80, then click OK.
11. Right-click the time slider again. Choose 0 as the Source Time and 80 as the Destination Time, then click OK.

This completes the head motion, but the right arm motions still need work. That comes next.

Animate the other arm with Copy Tracks:

Copy Tracks lets you copy and paste the animation tracks of selected objects to other objects, or to opposite body parts.

1. **Auto Key** Make sure Auto Key is still on.

2. In the Top viewport, double-click *Bip01 L Clavicle* to select the entire left arm.
3. Activate the Perspective Viewport
4.  In the Copy/Paste rollout, turn on the Track button.
5.  Choose Copy Tracks.

The track is copied to the buffer. Name the track LArm – Crawl.

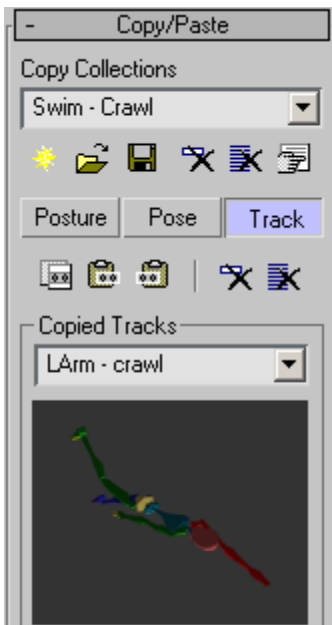

6.  Click Paste Track Opposite.

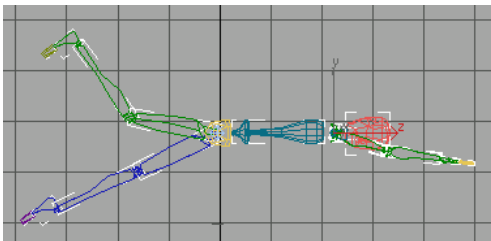

7.  Play the animation.

The biped is swimming the butterfly stroke. The two arms move together.

Next you'll change the timing so the arms alternate.



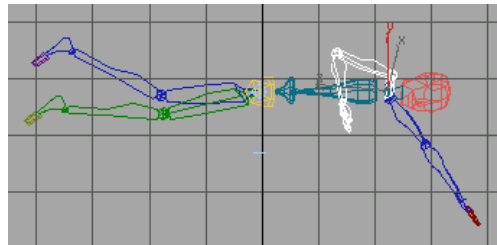

8. In the Top viewport, double-click the *Bip01 R Clavicle*.
The entire right arm is selected in the viewport.
9. Drag a box around all the keys in the track bar to select them. Slide all the keys 20 frames to the right.



The biped swimming a freestyle stroke

10.  Play the animation.
Now the beginning and end are not quite right. The easiest way to correct this is to copy and paste poses.

Fix the beginning and end:

1.  Make sure Auto Key is still on.
2. In the Top viewport, double-click the *Bip01 R Clavicle* to select the entire right arm, if it's not already selected.
3.  On the Copy/Paste rollout, click the Posture button.
4.  Move the time slider to frame 50 and click Copy Posture.
5.  Move the time slider back to frame 10 and click Paste Posture.

- At frame 40, click Copy Posture, then at frame 0, click Paste Posture.

Now the arms alternate.

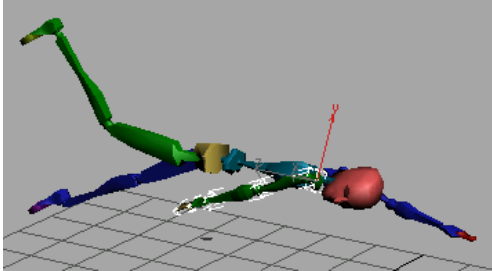

To correct the other end of the animation, you can crop the animation to 80 frames.

-  In the time controls, click Time Configuration.

The Time Configuration dialog is displayed.

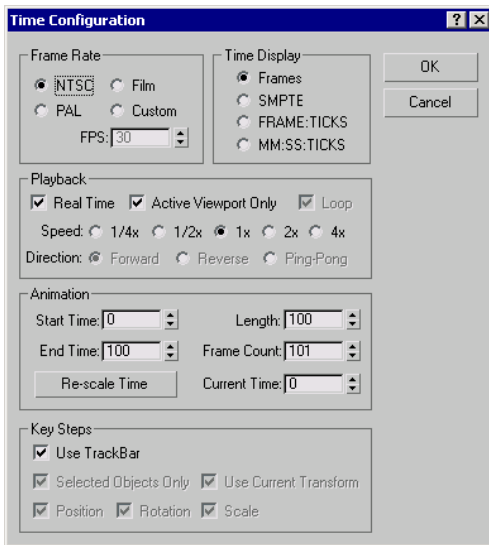

- In the Animation group, change the End Time to 80. Click OK.

Warning: Do not click Re-scale Time.

-  Click Play Animation.

Save your work:

-  In the Biped rollout, click Save File and save the motion as **MySwimmer.bip**.
- Also save your final scene as **MySwimmer08.max**.

Perfecting the animation:

- If you like, you can improve the animation by adding some rotation keys to the pelvis and spine and by adding secondary motion to the feet and hands. Stagger the rotations of the extremities a few frames following the movement of the hands and feet.

Animating a Freeform Walk Cycle

While 3ds Max has a dedicated method (Footstep mode) for creating quick and easy walking animations, you can also create walk cycles with freeform animation.







In this tutorial, you'll use animated pivot points and IK blend keys to constrain the feet to the ground plane.

Set up the lesson:

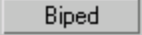
1. Restart or reset 3ds Max.
2.  From the Create panel, click the Systems button.

Create a biped and load FIG file:



1.  Click the Biped button and create a biped in the Front viewport.
2.  Open the Motion panel.
3.   Turn on Figure Mode and click Load File.

The Open dialog is displayed.



4. Open the file, *cs4_tut_rtgame.fig*.

The biped takes on new structural elements saved in the FIG file. This simplified figure has one large toe on each foot and one large finger on each hand; its spine contains two segments instead of four.



5.  Turn off Figure mode.
Note: You cannot animate in Figure mode.
6.  Select all the biped objects and click Zoom Extents All Selected.
7. Save the scene as **mywalk01.max**.

Set a key:

1. Change the Perspective viewport to wireframe and zoom in so the feet are clearly visible.
Tip:   In the display controls, use Field Of View and Pan to zoom in on the feet.
2. Select *Bip01 R Foot*.

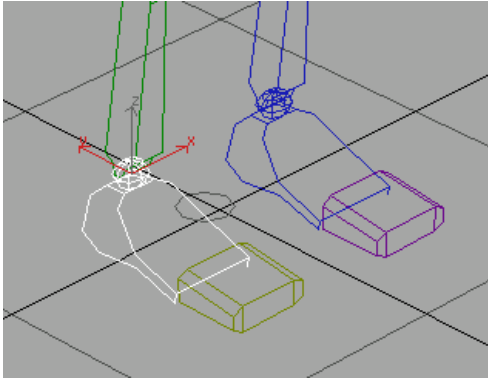

-  On the Motion panel, in the Key Info rollout, click Set Key.
 The foot is highlighted in white, and a key appears in the track bar at frame 0. You have just started a freeform animation.



Track bar key at frame 0

Set different types of keys at frame zero:

There are two methods to set character animation keys in 3ds Max. You can use the standard method of keyframing that involves turning on Auto Key and transforming objects. It is quick and easy, but if you forget that Auto Key is on, you may set keys unintentionally.

The second method uses the Set Key buttons on the Key Info rollout. The Set Key buttons set up several parameters at once. This is the method you'll use for the following lessons.

-  In the Track Selection rollout, choose Body Vertical.
 This selects the biped's center of mass, *Bip01*, and activates the Move tool in one step. You've set a key for the foot, but there is a problem.

- The foot can go through the ground plane. See for yourself in the next several steps.
- Right-click to activate the Left viewport without changing the selection set.
 - Select the Body Vertical Track in the Track Selection rollout, then move the center of mass down in the Left viewport.
- The biped moves down through the ground plane (as indicated by the grid in the Perspective viewport).
- Press **CTRL+Z** to undo.

Set planted keys:

Now you'll set a planted key. A planted key does three things: it sets IK Blend to 1, turns on Join to Previous IK Key, and also turns on Object Space. Together, these three settings ensure that the foot will not pass through the ground plane.

For more information about IK Keys, refer to the "Key Info Rollout" topic in the User Reference.

- In the Perspective viewport, select *Bip01 R Foot*, if it's not already selected.
-  On the Key Info rollout, click Set Planted Key.

The red pivot point becomes more pronounced.

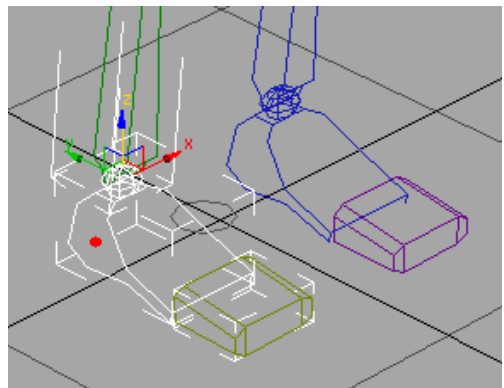

3.  On the Track Selection rollout, click Body Vertical, and move the biped down in the Left viewport.

The foot stays on the ground plane, and the knee bends to accommodate the vertical movement of the biped.

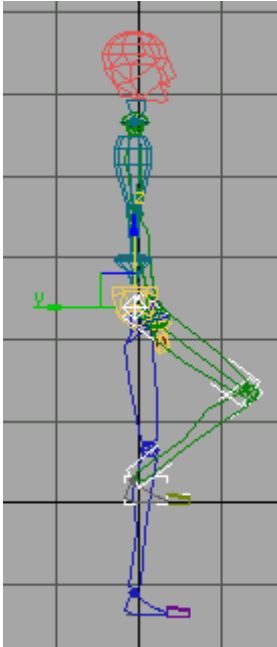

Planted foot stays on ground.

4. Press **CTRL+Z** again to reverse the movement of the center of mass and return the biped to its original position.

Now you've seen the effect of the planted key on the foot. You can use the same Set Key buttons on pivot points for the feet and hands. Next, you'll replace the key at frame 0 with a new one, changing the pivot point.

Set pivot keys:

1. At frame 0, right-click in the Perspective viewport and select *Bip01 R Foot*.

2.  On the Key Info rollout, click Set Planted Key.
3. On the Key Info rollout, open the IK expansion bar and click Select Pivot.

All pivot points for the foot are now visible as blue and red dots. The pivot at the ankle is red, showing that this is the currently active pivot point.



Wireframe mode lets you clearly see and select the pivot points.

4. Choose the pivot point on the ball of the foot, at the base of the toes.

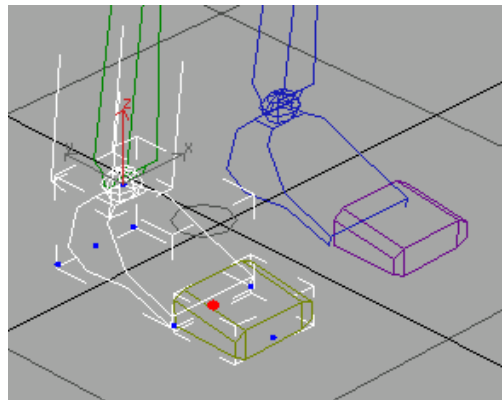
The new pivot point is displayed in red.



Note: You don't have to set a key each time you choose the pivot point. However, you should use the Set Key buttons if you want to change the Key parameters.

5.  Advance the time slider to frame 5, and click Set Key.
6.  Right-click the foot and choose Rotate from the quad menu. On the main toolbar, make sure you are set in Local Coordinate System.

7. Rotate the foot up approximately **15** degrees about the local Z-axis to make the heel raise and click Set Planted Key.

The heel lifts off the ground, the foot rotates on the ball, and the toes stay on the ground.

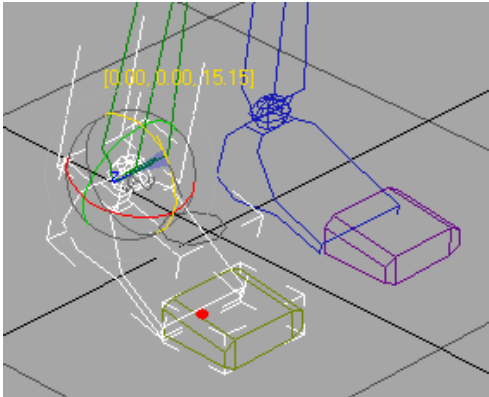

Now, you can animate the pivot point to the toes, as the ball of the foot lifts off the ground.

Animate the pivot points:

1.  Move the time slider to frame 10, and click Set Key.
2. Click Select Pivot and choose the pivot on the end of the toe.

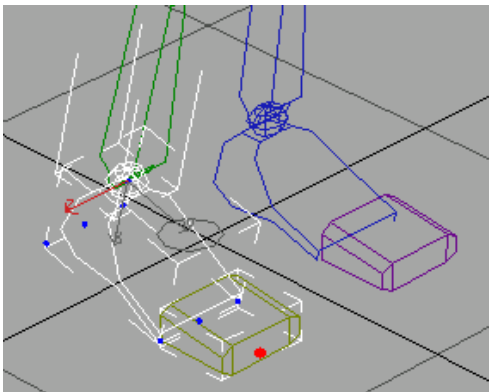

3.  Click Set Sliding Key to keyframe the pivot.

4. Click Select Pivot again, to turn it off.
5. In the Perspective viewport, right-click the foot and choose Rotate from the quad menu.
6. Rotate the right foot about **25** degrees around the Z-axis so the heel continues to raise and roll off the toes.

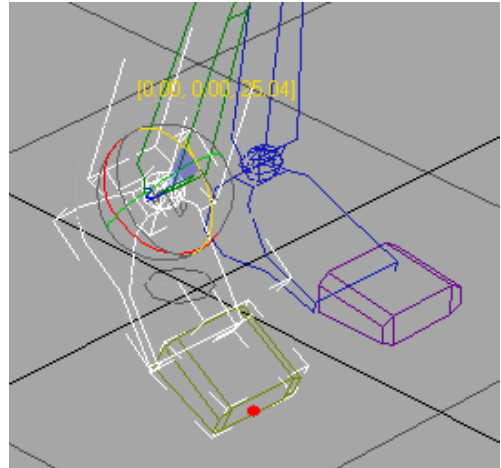

7.  Click Set Sliding Key to keyframe the foot rotation.

The sliding key does not join to the previous key, but has IK Blend set to 1, which keeps the foot above the ground plane. If you had set a planted key, the foot would jump to a different location as it attempted to join to the previous key.

Now, you can animate the pivot point to the toes, as the ball of the foot lifts off the ground.

Lift the foot off the ground:

When the foot lifts off the ground completely, you'll set a free key.

1. Move the time slider to frame 15.
2. In the Left viewport, right-click the foot and choose Move from the quad menu. Move the foot up off the ground and forward.

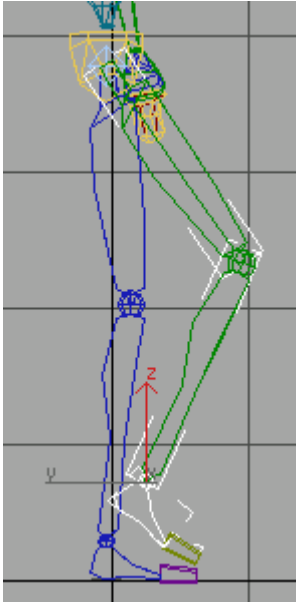

By moving the foot, you are seeing an example of biped's IK system. You are creating rotations for the upper and lower leg links as you move the foot.

3.  From the Key Info rollout, click Set Free Key to keyframe the lifted position of the foot.
4. Move the time slider back and forth to observe the animation so far.
5. Save the scene as **MyWalk02.max**.

Lock down the opposite foot:

1. Move the time slider back to frame 0 and select *Bip01 L Foot*.
2.  On the Key Info rollout, click Set Key.
3. Turn on Select Pivot and pick the pivot point at the ball of the foot.

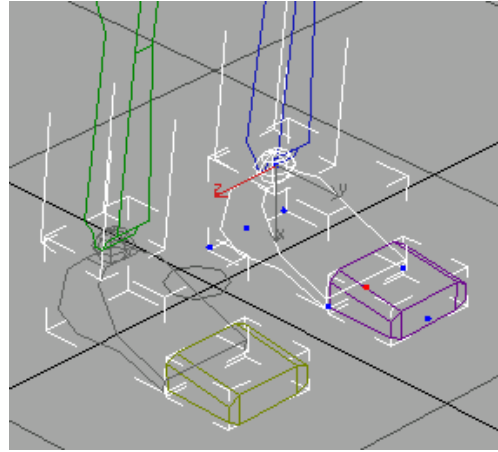



The left foot with a new pivot point

4.  Click Set Planted Key to set a the initial key for the left foot at frame 0.

This key locks the foot down for any subsequent movement in upcoming frames. If you were to grab the center of mass and move it down, both legs would bend instead of moving below the ground plane.

5. Click Select Pivot to turn it off.

Keyframe the center of mass:

1.  From the Track Selection rollout, click Body Horizontal. *Bip01* is automatically selected.
2.  At frame 0, click Set Key for *Bip01*.
This creates a start key for the center of mass.
3. Move the time slider to frame 15.
4. In the Left viewport, use the Move Transform gizmo to move the center of mass so the torso shifts forward, then set another key.

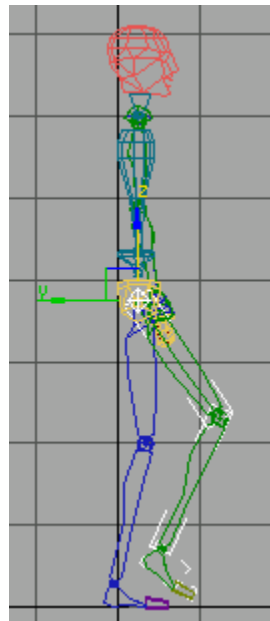

Note: Because the center of mass is the root node, use Set Key, rather than one of the specialized IK keys.

5. Use the Move Transform gizmo to move the center of mass down a little, so the left knee bends slightly, then set another key.

The left leg bends automatically as the center of mass moves down.

6. Select *Bip01 L Foot*.



7. On the Key Info rollout, set a planted key for the ball of the foot.

8. Right-click the left foot and choose Rotate from the quad menu. Rotate the foot so the heel is lifting up off the ground, and set another planted key.

The heel is rotated off the ground.

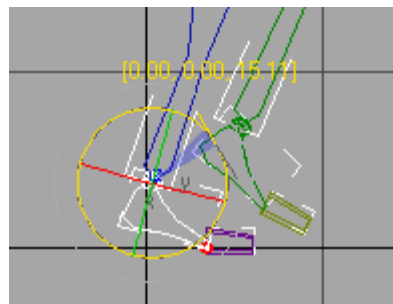



9. Move the time slider to frame 22 and click Set Key

10. Right-click in the Perspective viewport and turn on Select Pivot, then pick the pivot at the end of the toes of *Bip01 L Foot*.

11.  From the Key Info rollout, click Set Sliding Key, then turn off Select Pivot.

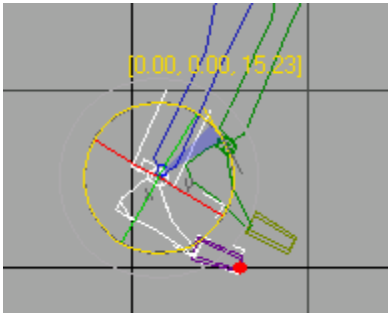
12. In the Left viewport, rotate the left foot up a little more and set another sliding key.



13.  On the Track Selection rollout, click Body Horizontal. Move the center of mass forward again, and set a key.

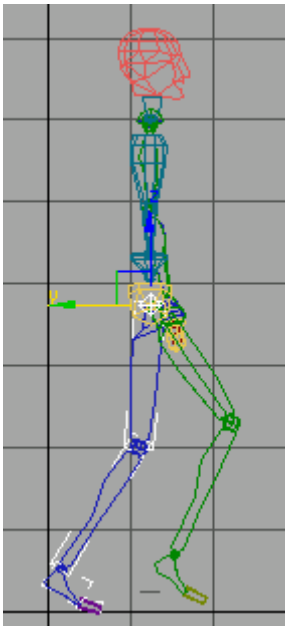

Keyframe the right heel hitting the ground:

1.  At frame 22, select *Bip01 R Foot* and move it forward, then set a sliding key.

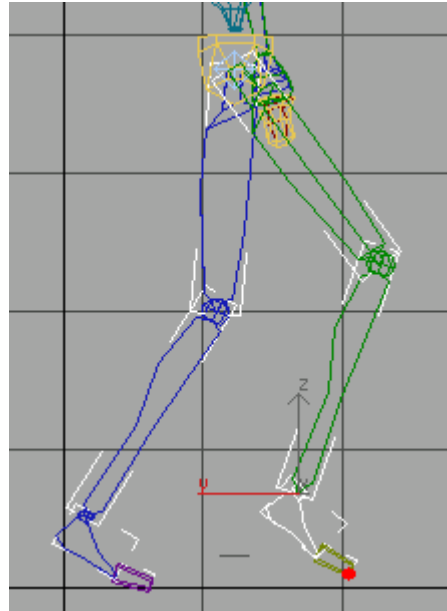

2. Turn on Select Pivot. Pick the point at the ankle that lies at the gizmo intersection, then set a sliding key.

3. Turn off Select Pivot. Rotate the foot so it's parallel to the ground, then set a sliding key.

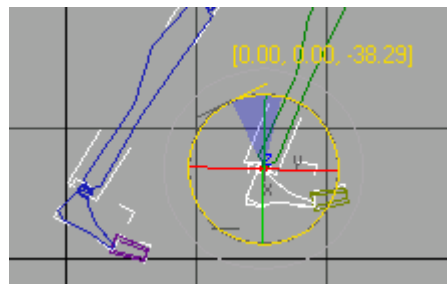

4. Turn on Select Pivot, and set the pivot to the heel. Set another sliding key.

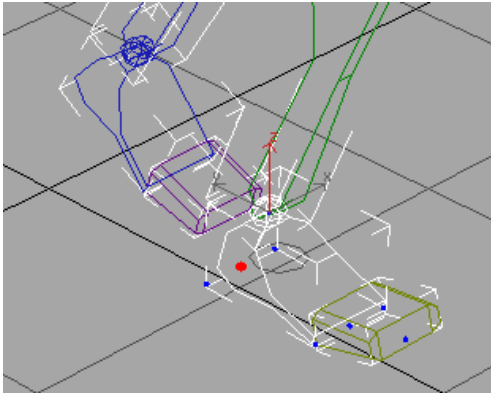

The pivot point moved to the heel

5. Turn off Select Pivot. Move the time slider to frame 27.
6. In the Left viewport, move the right foot forward a little.

Notice that the foot moves away from the pivot point in the viewport.

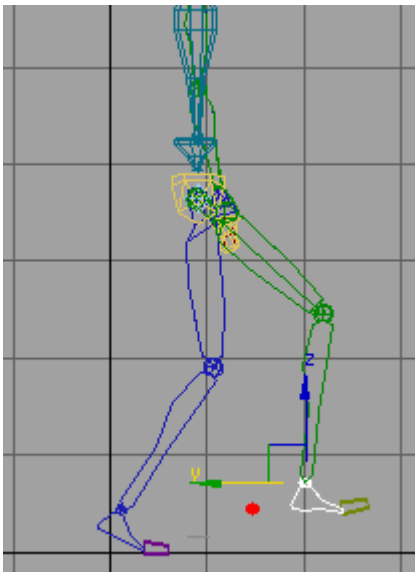

Sliding Key lets foot move away from pivot

7.  Set a sliding key.

The pivot point in the viewport moves to the heel of the foot.

8. Move the right foot down so it touches the ground, and set another sliding key.

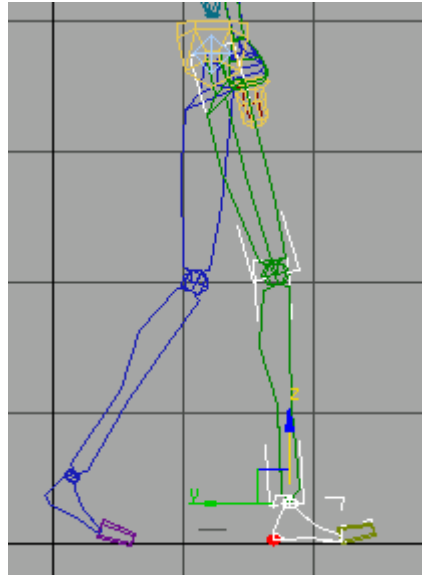

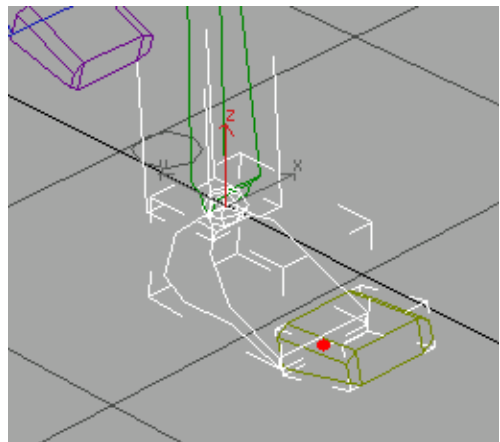

9. Turn on Select Pivot. Pick the pivot at the ball of the right foot.



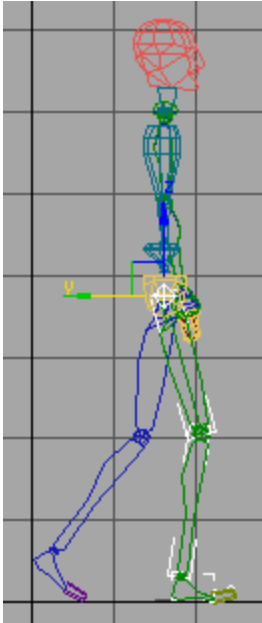

The pivot moved to the ball of the right foot

10.  Click Body Horizontal, move the center of mass so that it is over the heel of the right foot and set a key.



11.  At frame 27, select *Bip01 L Foot* and set a free key.
12. Move the time slider and watch the animation of the foot and the pivot points.
13. Save the scene as **MyWalk03.max**.

Continue the walk cycle:

1.  At frame 27, click Body Vertical so you can move the center of mass.
2.  Lower the body slightly, so the biped sinks a bit as the right foot flattens onto the floor. Set a key for the center of mass.
3. Move the time slider ahead to frame 32. Move the center of mass so it's over the ball of the right foot. Set a key for the center of mass.

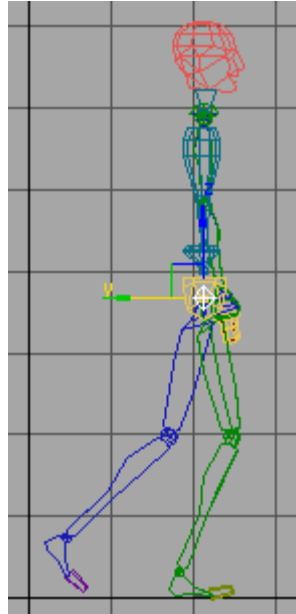

4.  Move and rotate *Bip01 L Foot* so the heel swings above the ground. Set a free key.

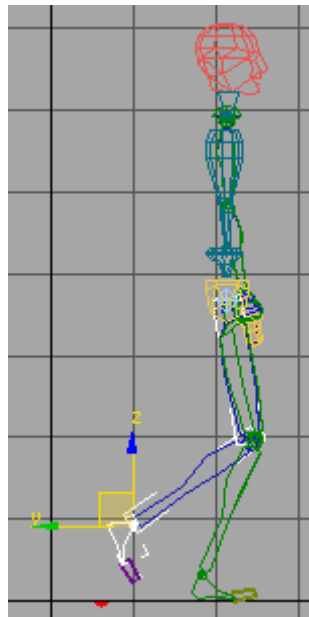

Use this procedure throughout this exercise: lock one foot by setting planted or sliding keys, move the center of mass, then move the other foot and set a key.

Complete the walk cycle:

1.  Move the time slider to frame 37 and click Body Horizontal. Move the center of mass forward and set a key.

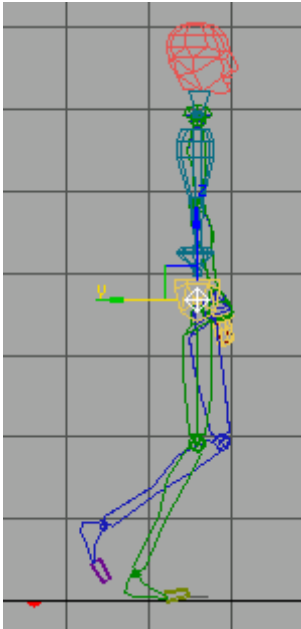



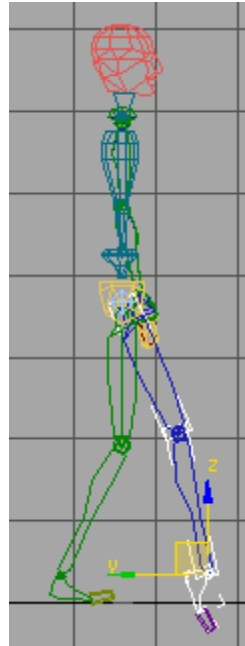



2.  Select *Bip01 L Foot* and move it so the leg is extended in front of the biped. Set a free key.

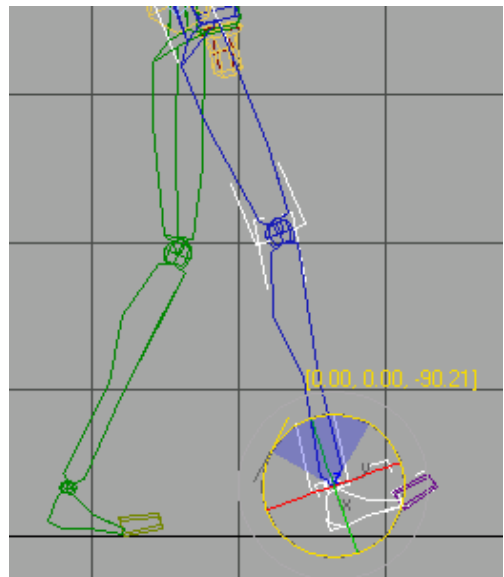

3. Rotate the left foot so the heel is down and the toes point upward. Set another free key.



Now the foot looks better.



4.  With the left foot selected, click Select Pivot and select the pivot at the heel. Set a planted key for the pivot.
5. Turn off Select Pivot.
6. Move to frame 39, and rotate the left foot so it is flat on the ground.
7.  Set a planted key for the left foot.
8.  Click Body Horizontal and move the center of mass so the body moves forward.
9.  Set a key for the center of mass.
10.  At frame 41, rotate the left toes so they are flat on the ground. Set a planted key.
11. Select *Bip01 R Foot* and move the time slider back to frame 30. Set a planted key.
12. At frame 32, rotate the right toes so they are flat, and set another planted key.
13. Move the time slider to frame 37 and rotate the right foot up a little, then set a planted key.
14. Move the time slider and review the motion. Add rotations for the toes as needed.
15. Save the scene as **MyWalk04.max**.

Display trajectories:

Biped has its own trajectory display. You can use it to observe the movement of the center of mass in the walk cycle. You can also edit the keys on the trajectory directly in the viewport.

1.  In the Track selection rollout, click Body Horizontal.
2.  From the Key Info rollout, turn on Trajectories.
3. Scrub the time slider, and watch the biped center of mass moving along its trajectories.

4.  Choose Select And Move on the Main toolbar. Turn on Sub-Object Trajectories, and then click any key on the trajectory.

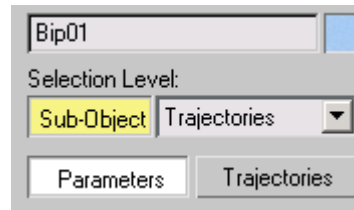

5. Use the Move Transform gizmo to move the keys to correct the trajectory.



Edit keys in biped trajectory

6. Turn off Biped Trajectories.

Warning: Don't use the 3ds Max Trajectories with Biped. Use the Trajectories button in the Display expansion bar or the Key Info rollout.

Add arm swings:

The character is starting to look like it's walking, but it's still pretty stiff. Adding arm swings will put some life in the animation.

The arms swing opposite to the legs. When the right leg is forward, the left arm is forward. Arms bend at the elbow on the forward swing, and stretch out straight on the backward swing.

1. Move the time slider to decide where to place the arm swings.

The right leg stretches out at frame 27, and you'll keyframe the left arm to swing there.

2.  Turn on Auto Key.
3. At frame 0, select and move the left hand slightly, to set a key.
4. At frame 0, select and move the right hand slightly, to set a key.
5. At frame 27, select and move the left hand so it swings forward.

Position the arm so there is a slight bend at the elbow. Since Auto Key is on, you have keyframed the arm by moving it.

6.  On the Track Selection rollout, click Opposite.

The right hand is selected.

7. Move the right hand back slightly, so the arm is stretched out.

The left arm is forward and bent a little, while the right arm is back and straight.

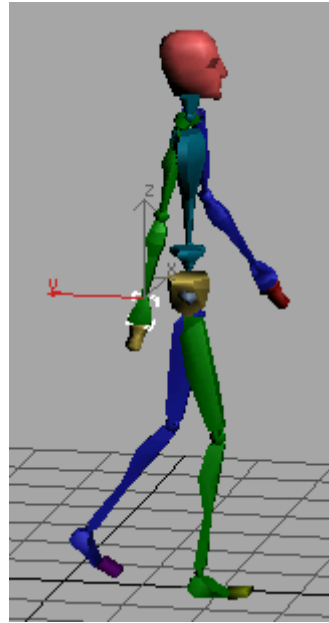

8. In the Front viewport, double-click on *Bip01 R UpperArm*.

The entire right arm is selected.





9.  On the Motion panel, open the Copy/Paste rollout and click Copy Posture.

10.  Click Create Collection. Name the Collection *walkcycle1*.

11. Turn on Create Snapshot from Viewport, just above the Paste Options group.



12.  Click Copy Posture. Name the Copied Posture *RArm back*.

13.  At frame 37, click Paste Posture Opposite. The left arm swings behind the biped.

14. At frame 27, double-click *Bip01 L UpperArm*. The entire left arm is selected.

15.  On the Copy/Paste rollout, activate the Perspective viewport and click Copy Posture again. Name the posture *LArm forward*.



16.  At frame 37, click Paste Posture Opposite. The right arm swings in front of the body.

17. Turn off Auto Key.

18. Move the time slider back and forth to evaluate the animation.

19. Save the scene as **MyWalk05.max**.

Add sway to the shoulders and hips:

You've animated the character by moving its hands and feet and center of mass. But the spine, hips, and head are still stationary. You'll add some rotations to the shoulders and hips to complete the walk cycle.

1. Select *Bip01 Pelvis* and move the time slider to frame 15.

The left foot is locked at this frame with a planted key.

Be careful where you add the hip rotations. Don't inadvertently disturb the work you've done on the feet so far.

As the legs extend and swing forward, the hips rotate slightly in the direction of the movement.

2.  Rotate the pelvis about the Y-axis approximately **-2** degrees and set a key.

Note: You can only rotate the pelvis about all three axes.

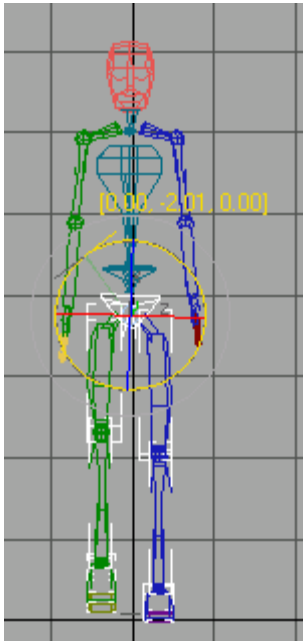

Rotation added to the hips from the Front view

The pelvis will not accept too much rotation. When you set the key, the pelvis corrects itself to account for the locked foot.

3.  Move the time slider back to frame 0. Rotate the pelvis back 2 degrees about the Y-axis and set a key. Rotate the pelvis back about -3 degrees about the X-axis and set a key.

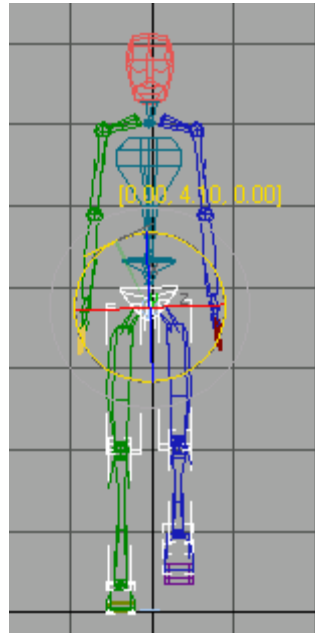

4. Move the time slider to frame 32. Rotate the pelvis about 4 degrees around the Y-axis, then set a key. Repeat for the X axis and set a key
5. Move to frame 39 and rotate the pelvis -2 degrees around the Y-axis again, then set a key. The procedure is the same for the spine. At frame 27, the arms swing out in one direction. At frame 37, they swing in the opposite direction.
6. Select the biped spine object, Bip01 Spine.
7. At frame 27, rotate the spine in the direction of the arm swing and set a key. It should be about -6 degrees around the X-axis.

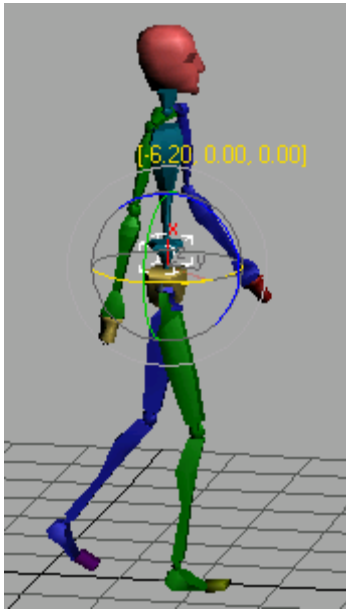

- At frame 37, rotate the spine approximately 12 degrees about the X-axis and set a key.

The spine can freely rotate about all three axes. You can make adjustments on each one. Rotate about the Z-axis for a more stooped walk.

Increase rotation about the X-axis to make the walk loose and floppy.

Instead of animating the spine, you can also animate the clavicles to raise or lower the shoulders.

Twist links mode:

The Bend Links rollout includes tools you can use for animation. You can use either the Bend Links or the Twist Links to animate the bending and/or twisting of the spine.

- Choose Figure Mode.

In the Structure Rollout change the Spine Links to 5. You can have up to ten spine links but you will use five to observe the effect.

- Turn off Figure Mode.

- Turn on Auto Key.

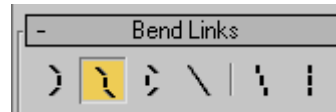

- In the Bend Links rollout turn on Twist Links mode.
- Select the *Bip01 Spine* object. This is the lowest spine object in the biped. 6. Go to frame zero and rotate the object very slightly about the X axis to add a key. Do the same about the Y axis.
- Go to frame zero and rotate the object very slightly about the X axis to add a key. Do the same about the Y axis.
- Move the time slider to frame 27 and rotate approximately 10 degrees about the X axis to the spine rotates following the swing of the arms. The blue arm is swinging forward, so rotate the spine to match.
- You can also rotate -1 degree about the Y axis. Notice that very small rotation of the first spine object results in a larger effect further up the hierarchy.
- Repeat at frame 37 in the opposite direction to match the swinging of the green arm outward.
- Save the scene as **MyWalk06.max**.

You have animated a simple walk cycle using freeform animation and IK constraints.

You can use the techniques found in the *swimmer tutorial* (page 1-344) to refine and finish the animation motions. Be sure to do that tutorial as well, if you've skipped it.

You can use the footstep method of animation to create a walk cycle automatically. To learn about this technique, see *Creating a Distinctive Walk* (page 1-303).

Using Controllers with Biped

You can add controllers on top of Biped animations to create a wide variety of effects. You can use scale controllers to create stretchy legs or arms for cartoon animation, or create the illusion of breathing by adding a scale controller on the spine objects in the chest. You can add noise rotation controllers to the spine to make a biped shake while he walks, or to create twitching or random motion in the limbs or head.

Controllers can be added in the Motion panel, Assign Controllers rollout, or by using the Workbench. For more tutorials with Controllers, see the Workbench lesson *Adding Controllers to Multiple Biped Objects* (page 2–631).

Although this lesson is performed with footsteps, it could have been accomplished just as easily with a freeform animation.

Create stretchy legs with controllers:

In this exercise, you will add a scale controller to a biped's legs to stretch them during a portion of an animation.

1. Open *stretchyleg_start.max*.
2. Play the animation.

The biped walks for 10 paces, zooms to a lower level, and then walks another five steps. You'll add the scale controller, then animate the biped so that its legs stretch during the period of the downward leap.

3. Move the time slider to frame 162, then select the *Bip01 L Thigh* object, the blue leg.
4. On the Motion panel, open the Assign Controller rollout.
5. In the controller list window, expand the Biped SubAnim entry.

Now you can see the three list controllers.

6.  Click the plus sign (+) next to *BipScaleList* to expand this controller. Select the entry marked *Available*, then click the Assign Controller button.

The Assign Scale Controller dialog appears.

7. Choose Scale XYZ from the list, and click OK to close the dialog.



8. On the 3ds Max Main toolbar, click the Select And Scale button.

The Scale gizmo is visible on the thigh in the viewport.

9.  Turn on Auto Key.

First, you will set a key to start the stretch. You don't want the stretch to start before frame 162. You want the biped to have a normal leg (unstretched) from the start of the animation up to this frame.

10. Using the Scale gizmo, stretch the leg *very* slightly in the X-axis at this frame, so the final value in the Coordinate rollout is 100 (no stretch).

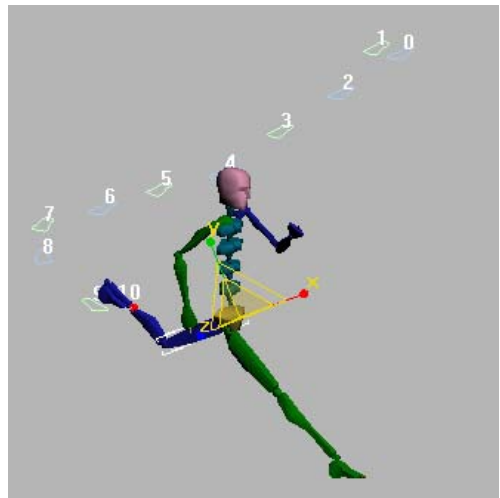

The leg at frame 162 (no stretch).

11. Move to frame 164, and stretch the leg so the foot reaches the footstep.

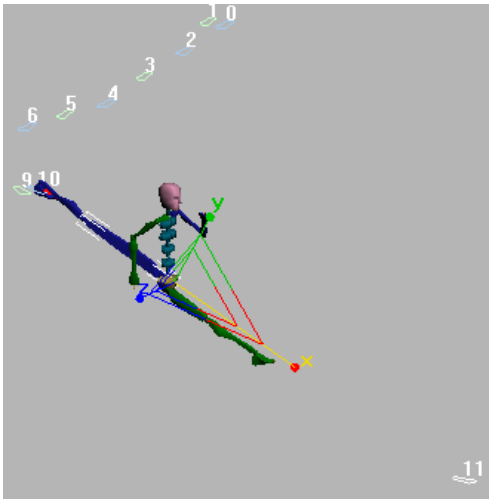

12. Move to frame 167, and again stretch the leg in the X-axis, so the foot stays on the footstep gizmo.

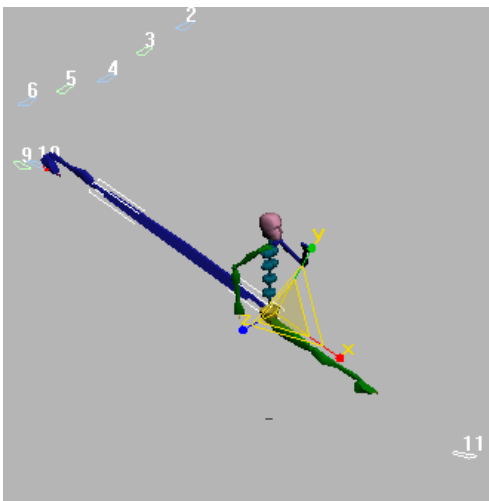

Leg stretch at frame 167

13. Move to frame 169. Here, you begin to shorten the leg stretch.

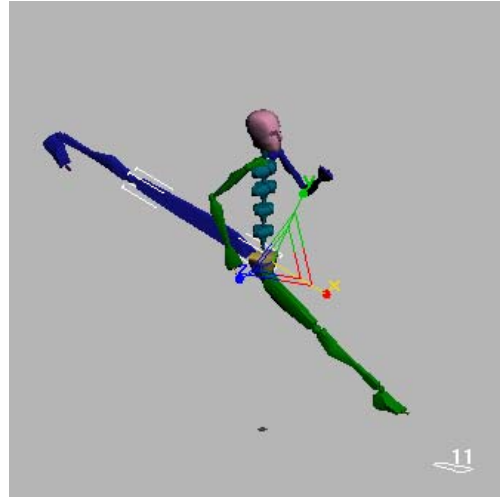

Leg shortens at frame 169

14. Move to frame 181 and stretch the leg back to normal. Adjust it visually until the leg looks correct.

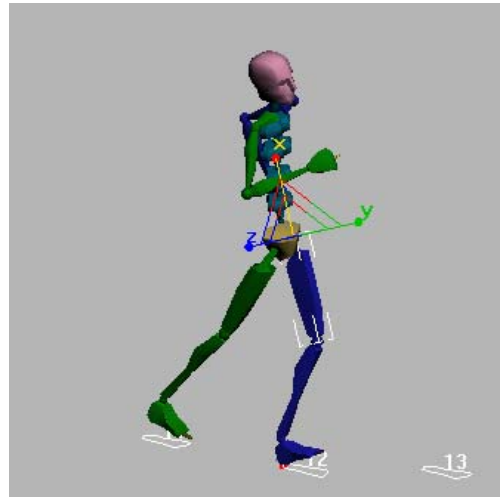

Leg at frame 181 appears normal.

15. Play the animation. The biped's back foot stays on the footstep and the leg stretches out as the biped descends to the lower set of footsteps.

For extra credit, add a scale controller to the green thigh, and stretch that leg out, roughly between frames 161 and 171.

16. Save your work as **mystretchy_leg.max**, or open *stretchyleg_final.max* for comparison.

Once you have controllers added to the biped body parts you can animate their parameters, or animate their weights. Here's an example that shows animation of parameters.

Animate the weights of SubAnim controllers:

1. Open *shake_and_walk_start.max*.
2. Play the animation.

The biped takes a few steps, then pauses for a moment or two, then walks on.

3. In the Perspective Viewport, select *Bip01 Spine*, the lowest spine object.

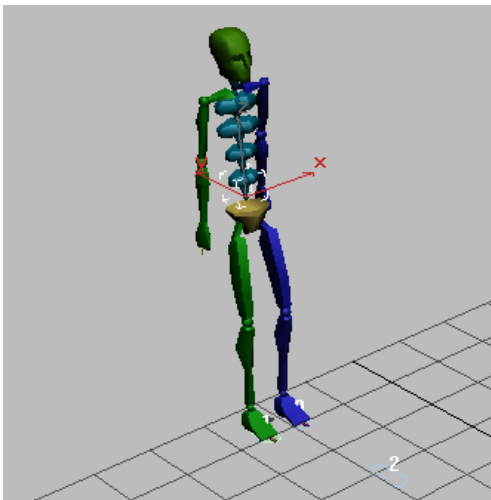

4. On the Motion panel, open the Assign Controller rollout.
5. In the Assign Controller window, expand the Biped SubAnim so you can see the list controllers.
6. Expand the *BipRotationList*, and highlight the entry marked *Available*.

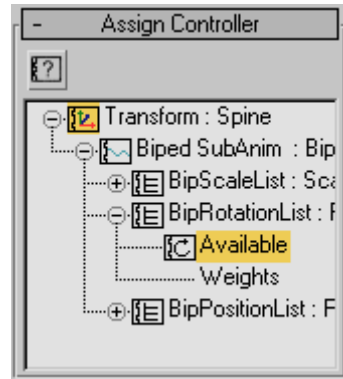

7.  Click the Assign Controller button.
The Assign Rotation Controller dialog appears.
8. Choose *Noise Rotation* in the list, and click OK.
The Noise Rotation Properties dialog is displayed. Don't close this dialog.
9. Play the animation in the viewport.
The biped shakes drastically as it walks.
10. In the Properties floater, turn Fractal Noise off.
11. As the animation plays, change the Frequency in the Properties dialog, using the spinner.
Lower the value until the shake becomes slower and more rhythmic. Probably a value of **0.2** or less will be good to use, but you can choose whatever you like.
12. As the animation plays, change the X, Y and Z values. Set the three values to **0**, then change them individually, one at a time.
To create a shimmy effect, set X Strength to be **2**, Y and Z Strength to **0**.

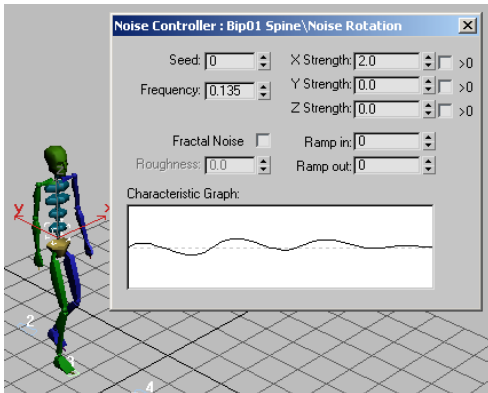

13. Close the Noise Rotation Properties dialog.

In this example, the biped should shake only while walking. The frames between 69 and 191 should not have any shaking. To complete this effect, you will animate the weight of the noise controller.

Animate the weight of the noise controller:

1. On the Motion panel, expand the Weight entry of the Noise Rotation controller you added to the spine object. Highlight *Weight 0*.

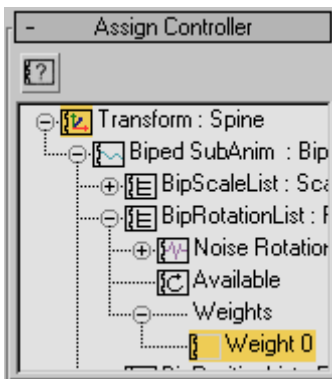

There is a trick to accessing the weights.

2.  Open the Keyframing Tools rollout and click the Manipulate SubAnims button.

The Motion panel now displays additional rollouts for Position List, Scale List, and Rotation List.

3. Scroll to the Rotation List and select the Layer -> *Noise Rotation*.

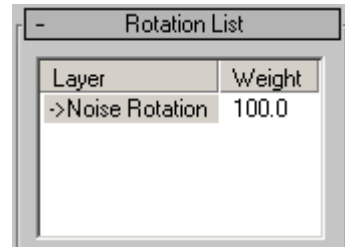

Now you're ready to animate the Weight field.

4.  Turn on Auto Key
5. Move the time slider to frame 70.
6. Near the bottom of the Rotation List rollout, right-click the Weight field spinner. This sets it to zero.
Tip: Right-clicking any spinner resets it to its lowest possible value.

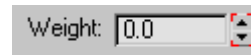

7. Move the time slider to frame 69.
Tip: Use the < and > keys on the keyboard to move from frame to frame.
8. Change the Rotation List Weight field to **100.0**.
The spinner is outlined in red to show it is animated.
9. Drag the time slider back and forth from frame 0 to frame 100 to see the animation. The biped shakes while walking and stops shaking during the pause.
10. Next, you make the biped start shaking again at frame 191. At frame 190, set a key with the Noise Rotation Weight set to **0**, and to **100** at frame 191.

Tip: At frame 190, hold down the SHIFT key while you right-click on the spinner. This will set a key without having to change the value.

11. In the Keyframing rollout, turn off Manipulate SubAnims when you're done.
12. Play the animation.
13. Save your file as **myshake_and_walk.max**, or open *shake_and_walk_finished.max* for comparison.

If you are exporting to a game engine, or if you want to use this animation with Layers or in the Motion Mixer, you will need to collapse the list controller animation (see following procedure). This will add the controllers animation keys to the tracks of the Biped SubAnim.

Note: 3ds Max has different behaviors for controllers and constraints. The controller animation will be *layered* onto the existing keys in the Biped SubAnim track. If you have used a constraint, however, it will *replace* the Biped Subanim tracks.

Collapse the list controller track:

1. Continue from before, or open *shake_and_walk_finished.max*.
2. If you open the file, select the *Bip01 Spine* object in the viewport, open the Motion panel, and expand the Assign Controller rollout.
3. In the Assign Controller window, highlight Biped SubAnim and then right-click.
4. Choose Properties from the right-click menu.

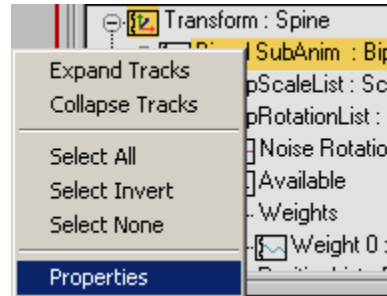

The SubAnim Property dialog appears.

5. In the Enable options, turn off Position List and Scale List, so the Rotation List is the only one active.
6. In the Collapse options, turn off Position, and turn on Rotation List, Don't Delete, and Per Frame.

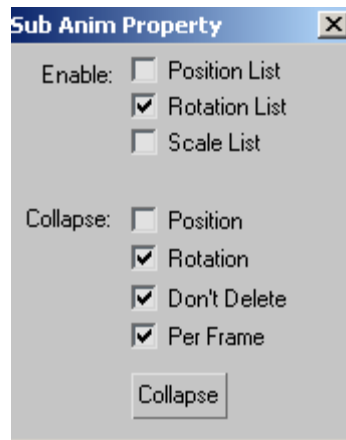

7. To collapse the rotation track, click the Collapse button at the bottom of the SubAnim Property dialog.

Wait while the calculations take place.

When the collapse is completed, the dialog closes and the track bar fills with keyframes.

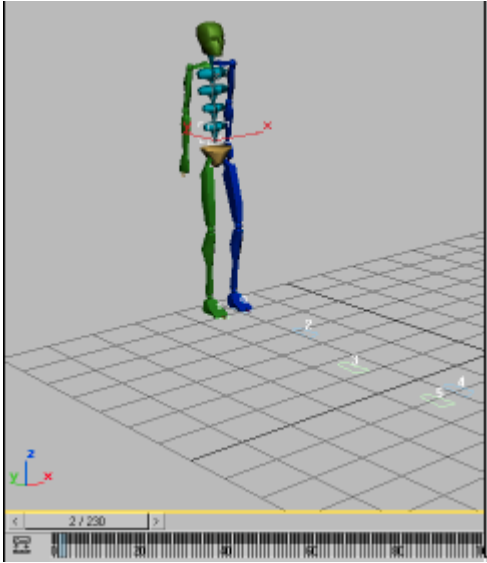

8. Save your work as **mycollapsed_shaking.max**, or open *shake_and_walk_collapsed.max* for comparison.

You can use the Workbench to reduce the keys that you've created. For a lesson on this technique, see *Filtering Animation* (page 2-628).

Creating Animated Bones with Biped

You can take the animated biped skeleton and use it to generate a 3ds Max bone structure that follows the same animation, by using the File Export and Import capabilities. In just a few steps you will be able to take your biped animation and use it without the biped attached.

Create animated bones from bipeds:

1. Open *createbones_start.max*.

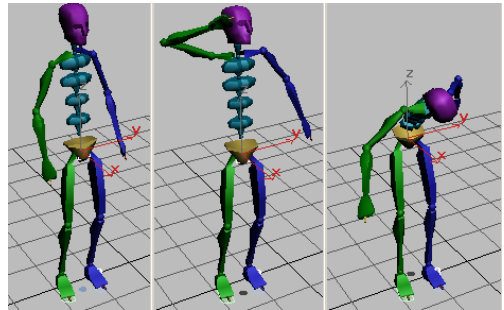

Biped takes a bow

2. Play the animation.
Observe the biped and its movement.
3. On the File menu, choose Export.
4. On the Save As Type list, choose FiLMBOX (*.FBX).

The Export FBX dialog appears.

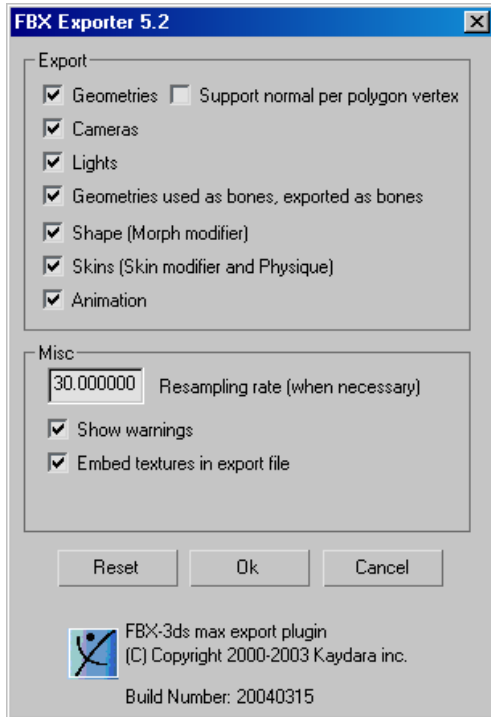

5. Accept all the default values and click OK. Name the file **mycreatebones.fbx**.

Wait while the export calculates the TRS animation.

6. On the File menu, click Reset.
The biped disappears, the viewports reset.
7. On the File menu, choose Import.
Select the file you just exported.
An import dialog appears

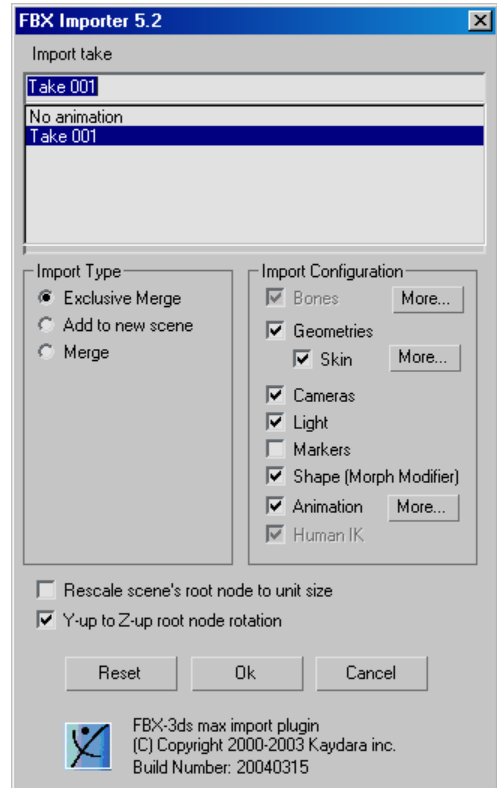

8. Click the More button next to the Bones entry.
In that dialog, set the Bone Width and Length to be **3.0000**.
9. Click OK to close the dialog. Click OK again to import the FBX file and create the bones.
A bone skeleton appears in the viewport.

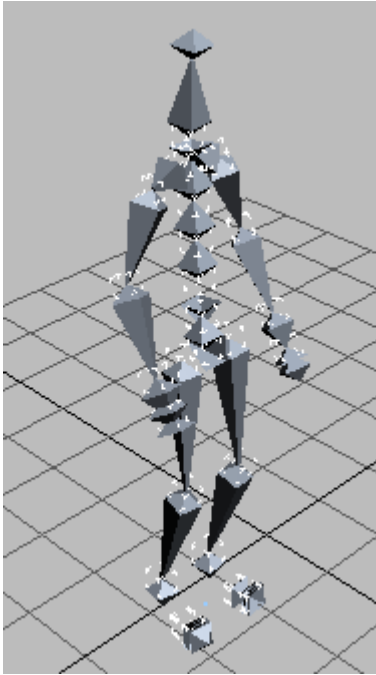

10. Play the animation. The skeleton has the identical animation as the original biped.

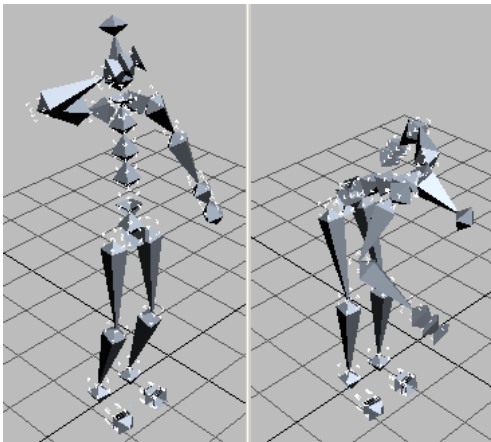

11. Save your file as **mycreatebones.max** or open *createbones_final.max* for comparison.

Adjusting the Biped to the Model

Getting Started with Physique

This tutorial shows you how to use the Physique modifier to associate a biped with a mesh and fine-tune the association.



In this tutorial, you will learn how to:

- Customize the biped structure
- Pose the biped to fit the mesh
- Adjust vertex assignments with envelope parameters
- Use control points to fine-tune the shapes and sizes of envelopes
- Adjust envelopes in shoulder and hip areas for the best deformation

Skill level: Beginner

Time to complete: 2.5 hours

You can find the files for this tutorial in the *tutorials\character_animation\physique_basics* folder on the Tutorial Files CD that ships with 3ds Max.

In This Tutorial

Working with Biped Parts (page 1–383)

Aligning the Biped to the Model (page 1–386)

Applying the Physique Modifier (page 1–396)

Adjusting Envelopes (page 1–400)

Fixing Shoulders and Hips (page 1–404)

Working with Biped Parts

The process of animating a character starts with a biped. In this lesson, you will learn to work with biped parts, creating a skeleton with the appropriate body parts to fit your mesh.

Set up for this lesson:

- Reset 3ds Max.

Create a biped:

1.  On the Create panel, click Systems.
2. On the Object Type rollout, click Biped.
The Biped button turns gold.
3. If you can't see the Height spinner in the Create Biped rollout, scroll to the bottom of the command panel.
4. In the Perspective viewport, place your cursor over the center of the grid. Press and drag upward.

A biped appears and grows with your cursor movement.

5. Drag upward until the Height value is approximately 70 units. A biped appears in the viewport.



The biped is a hierarchy of special objects. Its parent object (*Bip01*) is also called the center of mass or COM. The COM is displayed in the viewports as a small tetrahedron, initially centered in the biped's pelvis. After you create a biped, only the center of mass object is selected (not the entire biped).

After creating the biped, you change the values on the Create Biped rollout to give the biped the appropriate links for your mesh.

Change the number of fingers and toes:

1. Change the Fingers parameter to different values. You can see the number of fingers changing in viewports.

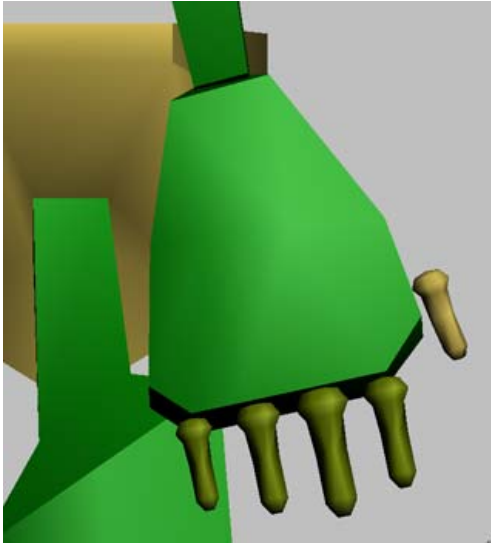

Five fingers

2. Set the number of Fingers to 5. This gives the biped four fingers and a thumb.
3. Change the Finger Links parameter to different values. Observe the finger links as they change in viewports.



Five fingers with three finger links

4. Experiment with the number of Toes and Toe Links, and observe the changes in viewports.

Add a tail and ponytails:

For non-human characters such as animals, you will need tail and ponytail links to control the mesh.

1. Change the Tail Links value to 5.

In the Left viewport, you can see the biped growing with a tail.

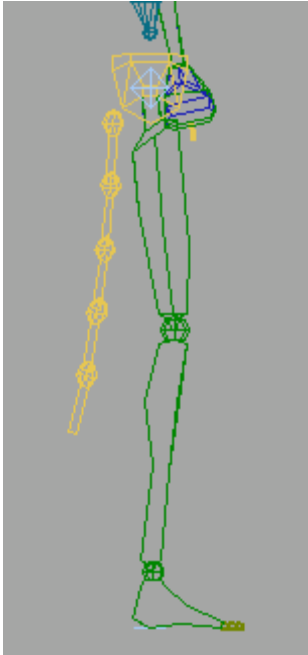

Biped with tail

As long as this biped remains selected, you can make changes to the biped parameters and see the effects.

2. Change the Tail Links spinner to **0**.
3. Change the Ponytail1 Links value to **5**.

In the Left viewport, you can see the ponytail growing from the base of the head. If necessary, two ponytails can be added.

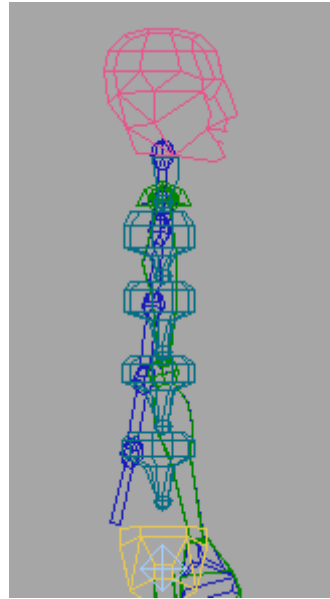

Biped with one ponytail (in blue)

4. Change the Ponytail1 Links value to **0**.

Add props:

Props are extensions of the biped skeleton. Props are linked to the COM, and can be animated to pass from hand to hand. You can use props to animate objects the biped is holding, such as tools or weapons.

1. Turn on Props 1, 2 and 3, and turn them off again.



Biped with Prop 1 activated

Once you have determined the appropriate parts for your biped, the next step is to align the biped to the mesh.

2. If you like, you can save this scene to the file **my_biped.max**.

Aligning the Biped to the Model

In this lesson, you'll pose a biped to fit a specific character by moving, rotating, and scaling biped parts.

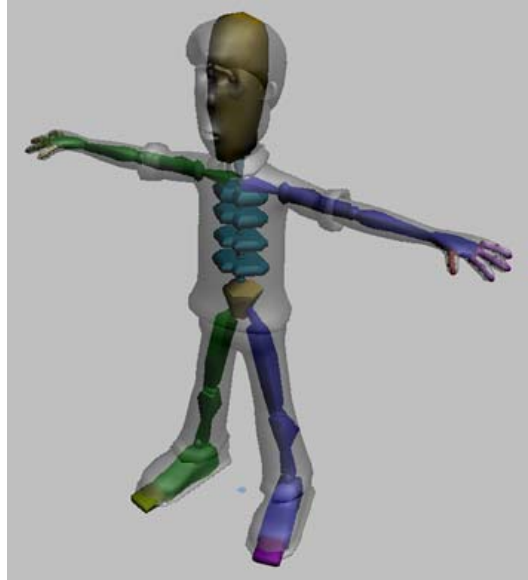

When correctly posed, the biped's torso, arms, and legs fit just inside the mesh. Fingers and toes extend just beyond the mesh to make skinning easier later on.

When posing the biped, Figure mode must be turned on. This mode tells 3ds Max that you are posing the biped rather than animating it.

The character you'll use in this lesson has a human form, and will not require a tail, ponytails, or props

Set up for this lesson:

1. Load the file *align_wilson_start.max*.

This scene contains a model of a man named Wilson.



The Wilson model

2. Inspect the model to see the number of fingers and toes. This model has three fingers and a thumb, and the fingers are short. Wilson is wearing shoes, so no toes are visible.

Prepare the model:

Your work with the biped will be much easier if you make a selection set for the model, make it see-through, and freeze it.

1. Select the entire model.
2. In the Named Selection Sets entry area on the Main toolbar, enter the name **Wilson Mesh**.
3. On the Display panel > Display Properties rollout, turn on See-Through.



The model turns gray and becomes see-through. Making the model see-through will allow you to see the biped as you pose it inside the model.

4. On the Display panel > Display Properties rollout, turn off Show Frozen in Gray.

This lets the model retain a little of its shading when frozen.

5. On the Display panel > Freeze rollout, click Freeze Selected.

You freeze the model so you won't accidentally select it while working with the biped.

Create a biped:

1. Choose Create panel > Systems > Biped.
2. Click near Wilson's feet in the Front viewport and drag upward to create a biped about the same size as the model.

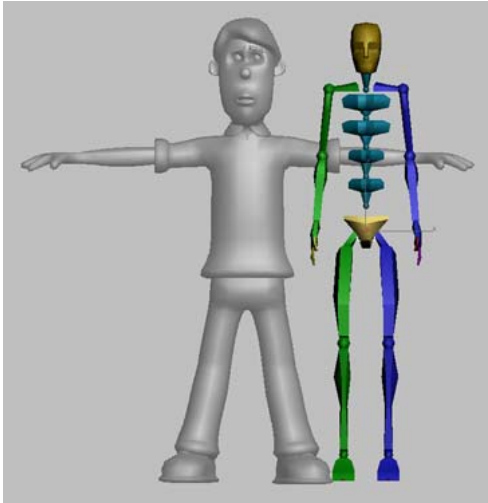

Because Wilson is wearing shoes, there's no reason to have separate toes. You'll give the biped just one toe with one link, which will control the entire ball and toe of the shoe.

- Near the bottom of the Create Biped rollout, change Toes to 1 and Toe Links to 1.



When you inspected the model earlier, you found that Wilson has three fingers and a thumb for a total of four fingers. The fingers are short, so only two finger links are needed.

- Set Fingers to 4 and Finger Links to 2.

Wilson's neck is rather stubby, so he needs only one neck link.

- Set Neck Links to 1.



Position the biped:

-  Open the Motion panel.
-  In the Biped rollout, click Figure mode to turn it on.

If the Biped rollout doesn't appear on the Motion panel, select any part of the biped to make it appear.

Important: Be sure to turn on Figure mode before continuing. Figure mode will retain the pose you are about to create.

- Select the center of mass (COM), the blue tetrahedron at the center of the biped's pelvis.

Tip:    You can quickly select the COM by clicking any of the selection buttons in the Track Selection rollout: Body Horizontal, Body Vertical, or Body Rotation.

- In the Front viewport, move the COM to the center of the model's hips.

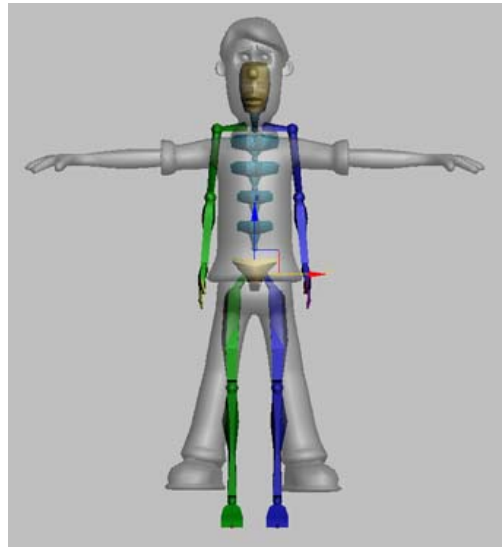

- Check in all viewports and move the COM as necessary to put it inside the character's hips.

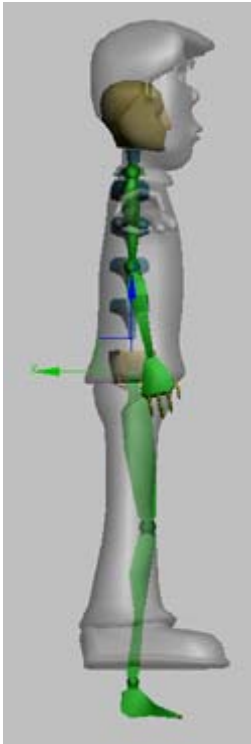

COM placed correctly in Left view

Pose the legs:

1. Select both the upper and lower parts of both legs.
2. In the Front viewport, scale both legs so the bottoms of the biped's feet align with the model's feet.

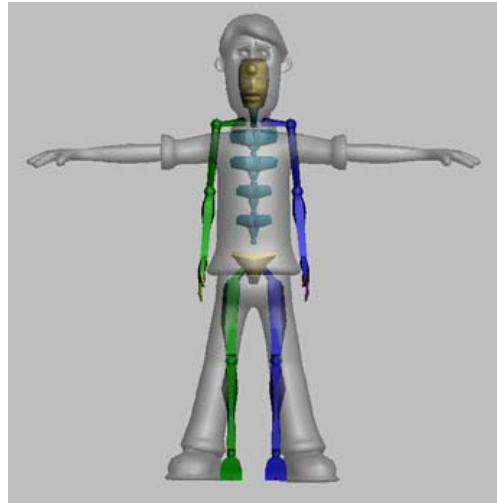

3. Select both thighs. Rotate the thighs to make the biped's legs parallel to the mesh legs.

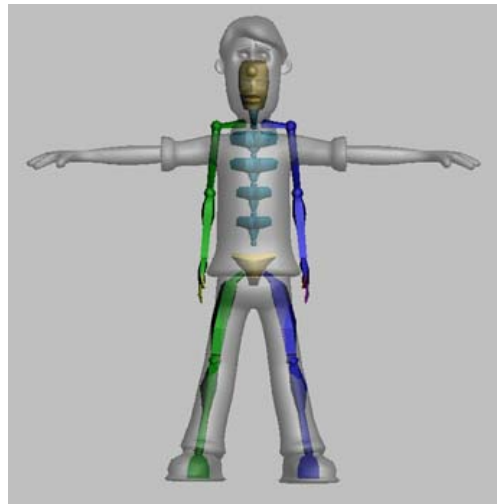

The goal is to make the biped's legs go down the centers of the mesh legs, but you can't do it until you scale the pelvis.

4. Select the biped's pelvis, the orange triangle around the COM.
5. Scale the pelvis on its local Z-axis so the biped legs go down the centers of the mesh legs.

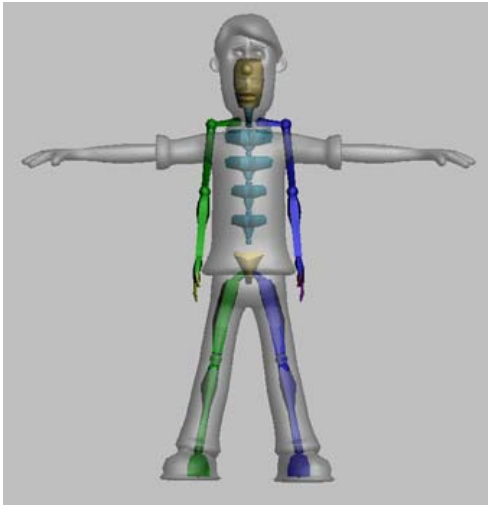

You might need to rotate the legs again, and scale the pelvis again. Work back and forth between scaling the pelvis and rotating the legs until the legs go straight down the middle of the mesh legs.

Scale the legs:

1. In the Left viewport, right-click the viewport label and turn on Edged Faces so you can see the knee detail on the pant legs.
2. Scale and rotate the thighs so the knee joint falls at the center of the knee detail on the pants.

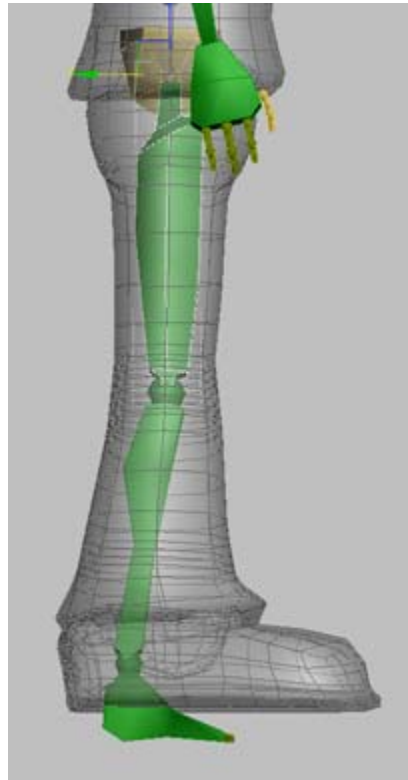

So far you have been posing both legs at the same time. It is possible to pose one leg or arm first, then copy and paste it to the other side.

3. In the Front viewport, select one calf. Scale the calf so the ankle joint falls just above the bottom of the pant leg.
4. Scale the foot so its bottom reaches the bottom of the mesh foot.

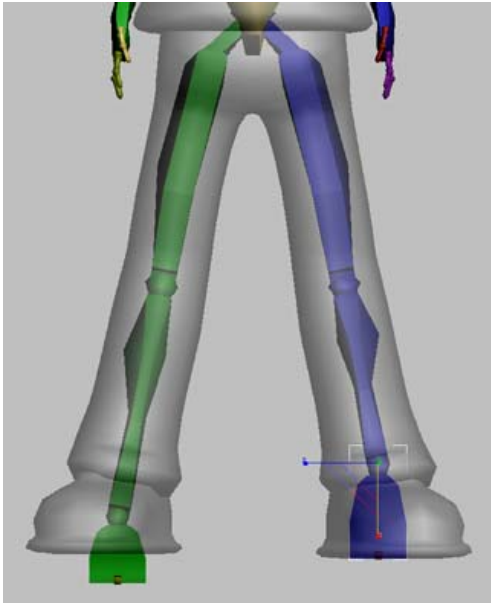

5. Select both the foot and calf you just scaled.

6.  In the Copy/Paste rollout, turn on Posture. Click Copy Posture.

7.  Click Paste Posture Opposite.

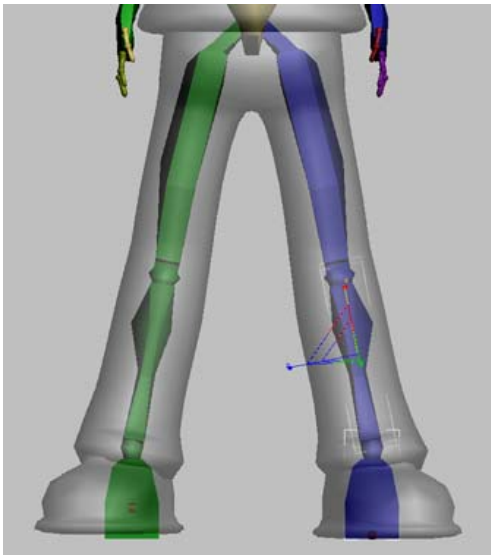

Now the two legs match.

8. In the Left viewport, check to see if the ankle joint meets the bottom of the leg. If not, change the Ankle Attach parameter on the Structure rollout to **0.2** or **0.25** to make the ankle match the leg.
9. In the Left viewport, rotate the thighs, calves and feet so they align as well as possible with the model.



The file *align_wilson_legs.max* contains the biped posed up to this point.

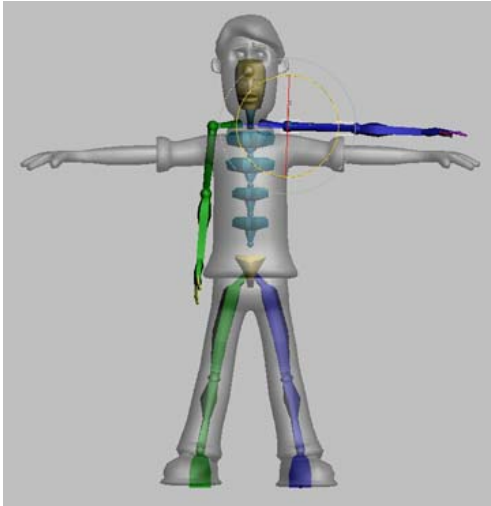

Position the arms and spine:

1. Select one of the biped's upper arms.
2. In the Front viewport, rotate the upper arm upward to make the arm parallel with the model's arm. Don't be concerned with fitting the arm at this time; simply make it parallel.

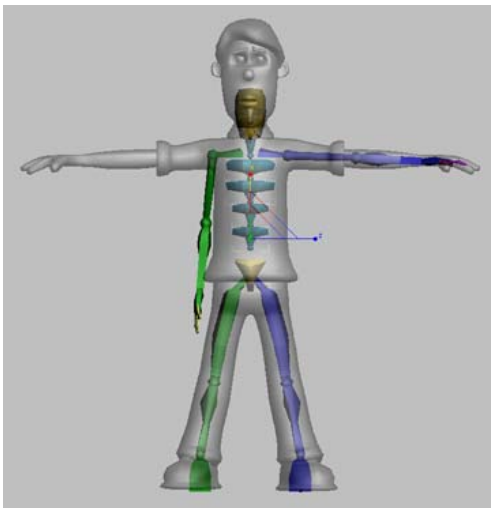

3. Select all the spine links and make a selection set called **Biped Spine**.
4. In the Front viewport, scale the spine upward or downward to make the upper arm fall into place.



5.   Select the posed upper arm. In the Copy/Paste rollout, copy and paste this pose to the other side of the biped using Copy Posture and Paste Posture Opposite.

6. Use the Biped Spine selection set to select the spine links. In the Left viewport, rotate the spine links slightly so they follow the curvature of the spine. You might need to move the lowest spine link to align the spine correctly.



Important: Don't rotate the COM when posing the biped. Instead, move the lowest spine link to adjust the position of the spine and upper body.

Now that the spine is curved correctly, the arms might be out of place again.

7. Use the named selection set to select the entire spine. In the Front viewport, scale the spine again to make the arms fall into place.
8. Check the spine again in the Left viewport to ensure it still follows the shape of the character's torso.

As with the legs and pelvis, you have to work back and forth between the spine and the arms to make both fall correctly inside the mesh.

9. In the Front and Left viewports, scale the widths of the spine bones to make them fit the mesh more closely.



Make each spine bone about two-thirds the size of the mesh. You will have to scale some spine bones more than others.

Pose the arms:

The posing of the arm starts with the clavicle bone, which connects the arm to the torso. Proper scaling of this bone leads to easier skinning of the underarm and shoulder areas later on.

1. Select one clavicle. In the Front viewport, scale the clavicle slightly along its X-axis so the biped's shoulder joint falls in the center of the mesh shoulder.

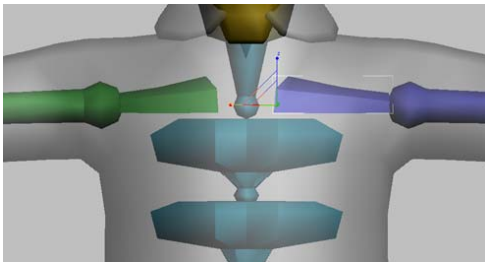

Left (blue) clavicle scaled slightly

2. In Top viewport, work with the upper and lower portions of the same arm. Scale and rotate the arm bones as necessary to fit it to the mesh, taking care to align the biped's elbow and wrist joints with the same joints on the mesh.

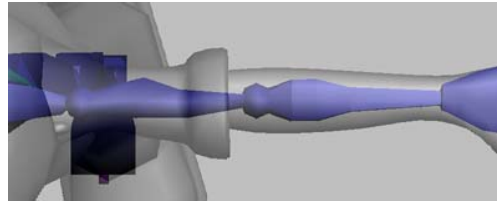

Posed arm in Top viewport

Tip: You can move quickly between parent and child bones by pressing PAGE UP and PAGE DOWN on the keyboard.

3. In the Front viewport, rotate the arm if necessary to make it go down the center of the mesh.
4. Select the clavicle, upper arm, and lower arm, and copy and paste the pose to the opposite side of the biped.

The file *align_wilson_arms.max* contains the biped posed up to this point.

Pose the hands:

Positioning the fingers is the most challenging part of posing the biped. Each finger joint must be moved and rotated separately.

You can rotate each finger and thumb joint, but you can move only the base of each finger and thumb.

You'll have an easier time posing the fingers if you work with the bases of fingers first, moving each one into place before rotating and scaling the finger joints.

1. In Top, Front, and User viewports, zoom in on one of the hands.
2. In the Top viewport, rotate the hand slightly if necessary to make it fit the mesh better.
3. Scale the biped hand so the palm nearly reaches the point where the pinky finger starts.

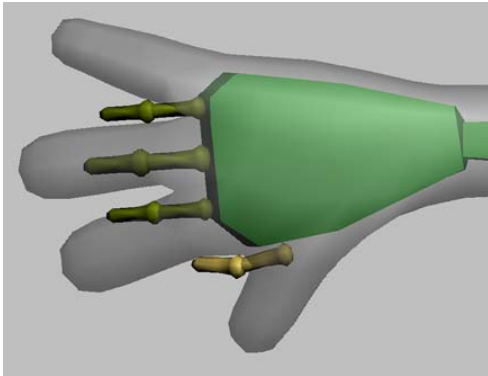

4. Check the hand in the Left viewport, and if necessary, rotate it to fit the center of the mesh hand.
5. In the Top viewport, move the base of the thumb and each finger to match the base of the corresponding digit on the mesh. Don't concern yourself with the rotation of the fingers just yet.

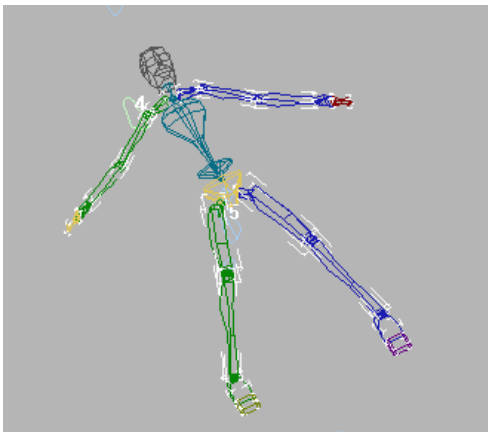

6. Rotate base of each finger and the thumb so each goes up the length of the corresponding mesh finger. You might find you have to move the base of the finger again to make it align correctly.

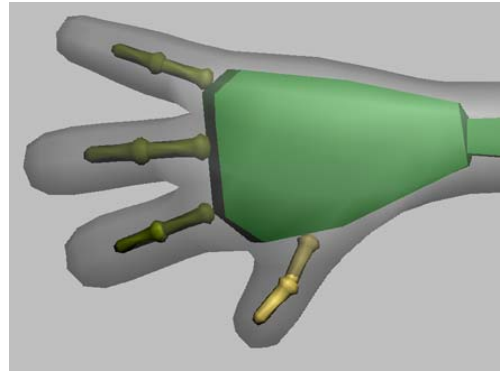

7. Scale the lengths of the finger joints so the first goes about halfway down the finger, and the last extends just beyond the mesh fingertip. This will help later on when skinning the character.

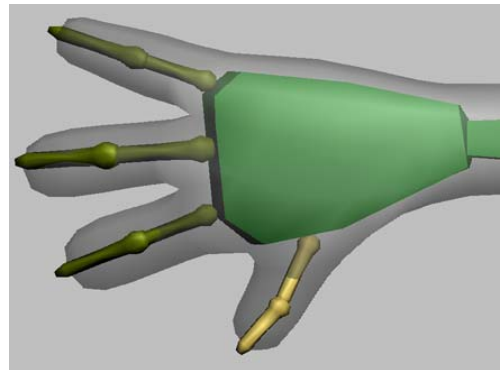

8. Using the Top and Front viewports, scale the width and height of each biped finger to about two-thirds the size of the corresponding mesh finger.
9. In the User view, rotate the finger joints to fit the fingers. You can also move each finger base up or down to improve the fit. Look at the hand from various angles to check the fit.

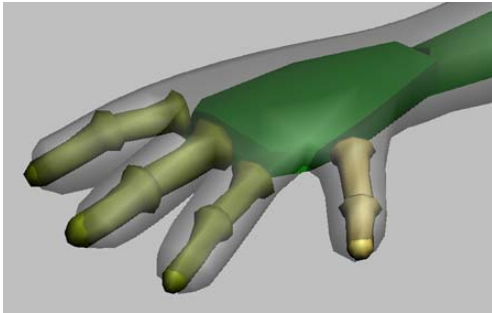

Tip: To rotate the view around the hand, select one or more finger bones and use Arc Rotate Selected in the User viewport.

There is no shortcut to posing the hand correctly. You must look at the hand carefully from all angles to ensure the bones are centered down the mesh fingers and thumb. The thumb bones can be challenging to pose because they rotate differently from the fingers.

10. When the hand pose looks good, select all the hand bones, and copy and paste the posture to other hand.
11. Check the fit of the bones on the other hand. If necessary, scale or rotate the lower arm to make the fingers fit on the other side.

When a mesh is symmetrical, the hand bones should make an exact fit when pasted to the other side. However, meshes are not always perfectly symmetrical. In addition, if the center of mass is slightly off center, the hand will not fit exactly.

The file *align_wilson_fingers.max* contains the biped posed up to this point.

Pose the head and feet:

1. In the Left viewport, rotate and scale the neck link so the biped's chin aligns with Wilson's chin. Do not rotate the head.

2. In the Front viewport, scale the head to about half the width of Wilson's head, and to its full height.

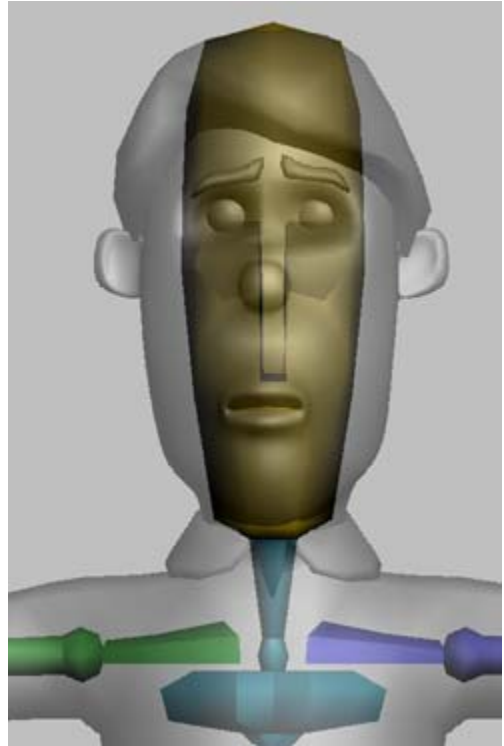

3. In the Top viewport, rotate the biped's feet to match the angle of Wilson's feet.
4. In the User and Left viewports, scale the foot and toe bones to represent the bulk of the shoe and the toe portion of the shoe. If you have difficulty selecting the toe bone, select the foot and press PAGE DOWN.

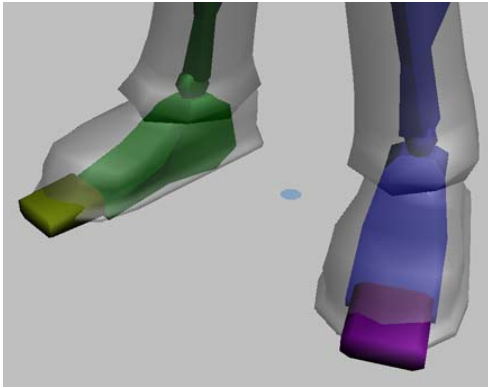

Complete the posing process:

1. As necessary, scale biped parts so they are about two-thirds the width of the mesh.

Wilson's pose is now complete.

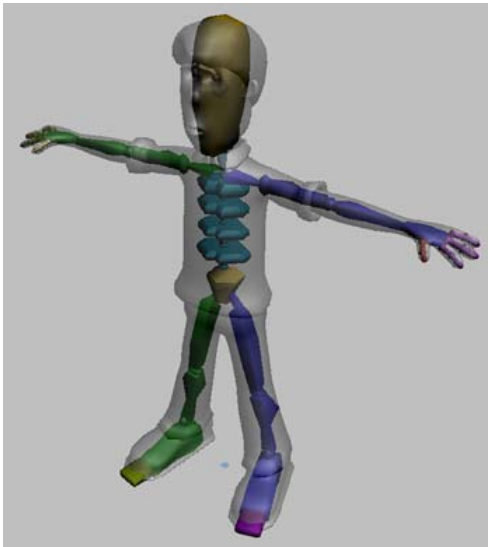

2. Select the entire biped, and create a named selection set called **Wilson Biped**.

Tip: It's best to wait until you've finished posing the biped to make a biped selection set. If you change parameters on the Structure rollout and add more parts while you're posing, any parts

added in this way will not be part of a selection set made at the start of the posing process.

3. In the Biped rollout, click the expansion bar to display the Name field.
4. Enter **Wilson Biped** in the Name field.

All biped parts are now preceded by the words *Wilson Biped*. Naming the biped in this way greatly assists the process of merging characters into scenes with multiple bipeds.

Tip: Giving each of your bipeds a unique name is a good practice. For example, if you decide to merge the character into a scene that contains other bipeds, the merge process won't ask you about duplicate names, and you'll be able to tell them apart easily when selecting objects.

Save the pose:

1. Choose the named selection set *Wilson Mesh*, and click Yes on the warning dialog.
2. On the Display panel, turn off See-Through.
3. Save the scene to the file **my_wilson_pose.max**.

A finished version of the pose can be found in the file *align_wilson_complete.max*.

Applying the Physique Modifier

After the biped is posed to match the character mesh, you apply the Physique modifier to the character mesh and associate it with the biped. The Physique modifier makes it possible to control the mesh with the biped's motion.

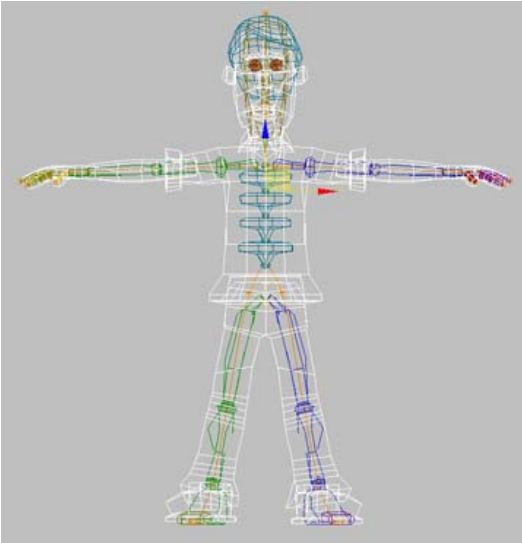

The Physique modifier makes the biped act as a skeleton under a mesh “skin”. Physique assigns each vertex in the mesh to one or more bones in the biped. When the biped bones are animated, appropriate vertices in the mesh will move along with each biped part.

The process of applying and adjusting Physique is called *skinning*.

Set up for this lesson:

1. Load the file *my_wilson_pose.max* that you created in the lesson *Aligning the Biped to the Model* (page 1–386). Alternately, you can load the file *physique_wilson_start.max* from the CD.

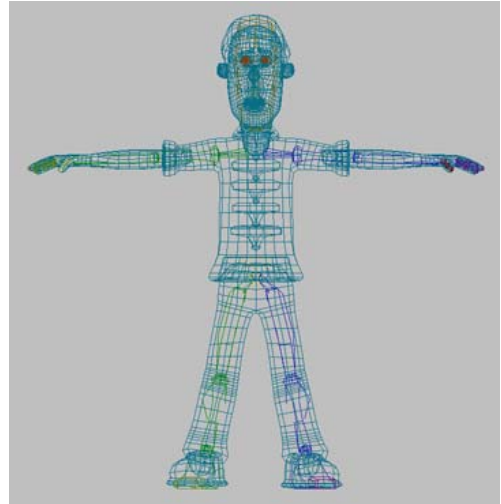



This scene contains the character Wilson and a completely posed biped.

The Physique modifier will be applied to Wilson’s head and body, but not his eyes or hair. These objects will be dealt with in a different fashion later on.

In general, the skinning process is easiest when models are as low-poly as possible. Both Wilson’s head and body have been smoothed with the MeshSmooth modifier. If you were applying Physique to just one of these objects, you could simply apply it below the MeshSmooth modifier on the modifier stack. Because you’ll be applying it to two objects at the same time, you’ll need to remove MeshSmooth from both objects and reapply it later.

2. Select the object *Wilson Mesh Body*.

3.  Open the Modify panel.

4.  Highlight the MeshSmooth modifier on the modifier stack, and click Remove Modifier From The Stack.

5. Select *Wilson Mesh Head* and remove the MeshSmooth modifier from its stack.

Turn on Figure mode:

1. Press the **H** key and select *Wilson Biped*. This selects the biped's center of mass.



2. Open the Motion panel.



3. If Figure mode isn't already on, turn it on.

Apply Physique:

You apply Physique as you would any modifier in 3ds Max.

1. Select the objects *Wilson Mesh Body* and *Wilson Mesh Head*.
2.  On the Modify panel, choose the Physique modifier from the Modifier List to apply it to the selection.

The Physique modifier appears on the stack in italics to indicate that it is instanced (applied to more than one object at a time).

Attach the biped and mesh:

1. In the Front viewport, zoom in on the biped's center of mass.



2. In the Physique rollout, click Attach To Node.
3. In the Front viewport, click the biped's center of mass.

The Physique Initialization dialog appears.

4. Click Initialize on the dialog.

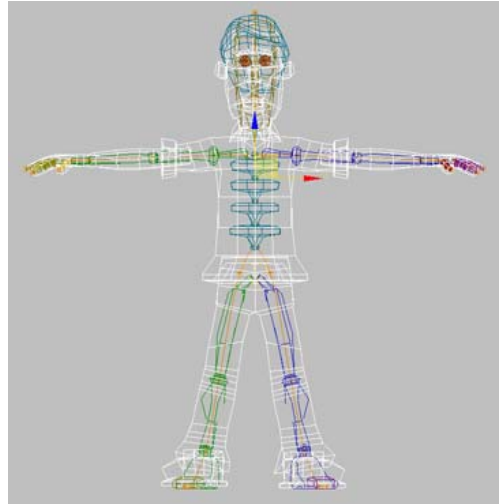

An orange skeleton line appears throughout the mesh. If Physique has been properly applied, the line should extend up through the head, down through all the fingers and through to the ends of the toes.



If the orange skeleton line does not go to the ends of the head, fingers, and toes, this means you picked an object other than the center of mass after clicking Attach To Node. If this happens, click Attach To Node and repeat the last few steps until the orange skeleton line appears correctly.

Create a test animation:

Physique assigns vertices to specific biped bones based on the size of each bone and its proximity to vertices. With careful posing of the biped, the default assignments can be quite accurate, but some adjustment is always needed.

The fastest way to check vertex assignments is to make a simple animation with the biped and watch how the mesh responds. You'll hide the mesh while animating the biped to minimize the distraction.

1. Select the named selection set *Wilson Mesh*, and hide the selected objects.

2.  Select any part of the biped and go to the Motion panel.
3.  Turn off Figure mode.
4. Expand the Key Info rollout. On frame 0, select the biped's upper arms and thighs, and click Set Key.
5. Go to frame 10.
6. Turn on Auto Key.
7. Pose the biped with one arm up and one arm down, and with legs split front and back slightly.

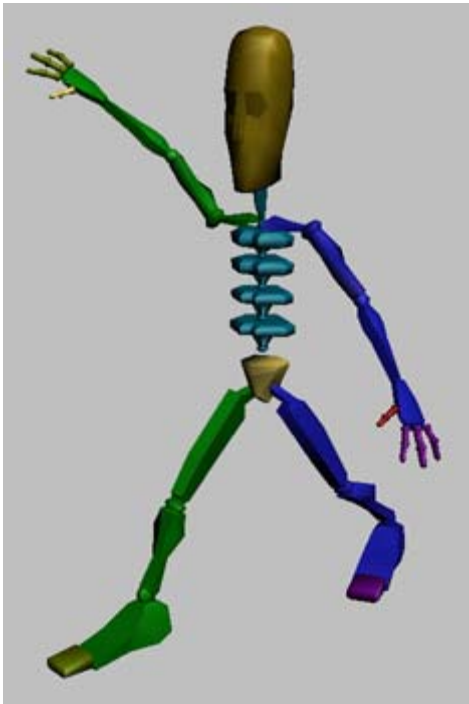

8. Scrub the time slider to see the simple animation.
9. Turn off Auto Key.

Check the default vertex assignment:

1. Go to frame 0.

2. Unhide the mesh.
3. Scrub the time slider to see how the mesh responds to the animation.



A few difficulties are immediately apparent:

- Parts of the pant legs are left behind when the legs move
- Parts of the sleeves are left behind when the arms move
- Hips are slightly crumpled

Note: If you used your own version of the posed biped, your problems with the mesh might be slightly different.

You will fix these problems by adjusting envelopes in the next lesson.

4. Save your work in the file **my_physique_wilson.max**.

A finished version of this lesson can be found in the file *physique_wilson_complete.max*.

Adjusting Envelopes

The bulk of the work in Physique consists of adjusting the size and overlap of envelopes to fine-tune mesh behavior as the character moves.

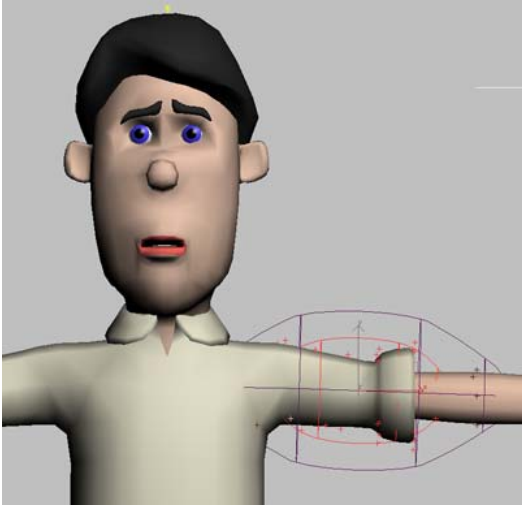

For the best results, each area of the mesh requires some attention.

- Each envelope should encompass its surrounding vertices
- Hip and shoulder areas must be adjusted for smooth deformation when the biped walks or stretches
- The head requires a rigid envelope for minimal deformation

As you adjust the envelopes, inspect the mesh from various angles. A test animation will also reveal different flaws in the mesh as the biped posture changes.

Set up for this lesson:

1. Load the file *my_wilson_physique.max* that you created in the lesson *Applying the Physique Modifier* (page 1–396). Alternately, you can load the file *envelopes_wilson_start.max* from the CD.



This scene contains the character Wilson and a posed biped. MeshSmooth has been removed from the character for the time being. Physique has been applied to the model, but the envelopes haven't been adjusted.

The biped isn't needed for envelope adjustment, so you can hide it for now.

2. Select the *Wilson Mesh Body* object.
3. Open the Modify panel.
4. In the Physique Level Of Detail rollout, turn on Hide Attached Nodes.

The biped is hidden, and you have a better view of the mesh.

Tip: Turning on Hide Attached Nodes has the same effect as hiding the biped with the controls on the Display panel.

5. Scrub the time slider to frame 10.

The biped is animated very simply, just enough to show you the main problem areas. The problems with the mesh are:

- The sleeves don't go with the upper arm

- The pant legs don't go with the legs as they split
- The hips do not deform smoothly

If you're using scene you created with the last two lessons, it's possible that your biped pose differs slightly from the file included on the CD, producing different problems with the hands, fingers, legs, or feet.

In this lesson, you'll learn to fix the first two problems listed above. You can apply the same principles to other body parts, such as fingers and toes.

Tip: To get a better look at the envelopes and vertices as they change shape, change the Perspective view to a User view and turn on Edged Faces .

Adjust the arm envelopes:

1. In the Front viewport, zoom in on the upper body. The time slider should be at frame 10.
2.  Go to the Modify panel.
3. Expand the Physique modifier listing on the stack, and choose the Envelope sub-object. The links in the body turn yellow.
4. Click the link for the left upper arm.

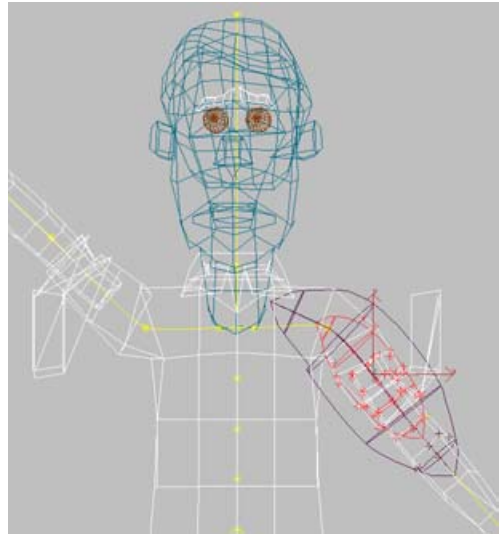

Two envelopes appear around the arm link. The vertices inside the envelopes are influenced by the bone. The inner red envelope indicates the area of most influence. The link's influence decreases until it reaches the purple outer envelope. Vertices outside the envelopes are not affected at all by the bone.

Vertices affected by the currently selected envelope turn various colors to show they are influenced by the envelope.

The radius of each envelope can be changed with the Radial Scale parameter. Increasing the radius enlarges the envelope to encompass more vertices, increasing the number of vertices affected by the bone.

Tip: To see the envelopes' influence in color in a shaded viewport, turn on the Shaded option in the Blending Envelopes rollout > Display group.

5. In the Blending Envelopes rollout > Envelope Parameters group, increase the Radial Scale parameter until all the vertices in the sleeve pop into place.

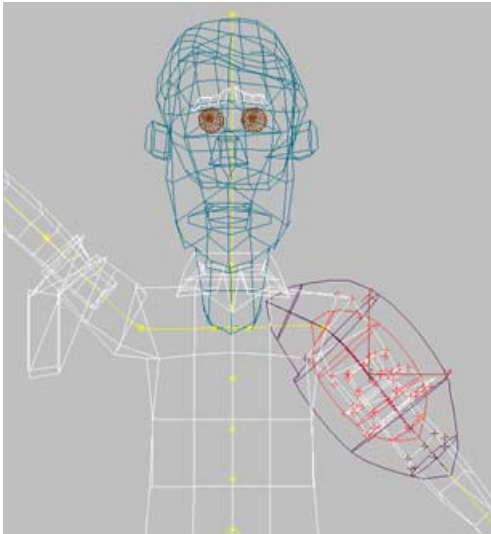

To make the other arm's envelope the same, you can copy and paste the envelope settings.

6. In the Edit Commands group, click Copy.
7. Select the right upper arm link and click Paste. The sleeve pops into place for the opposite arm.

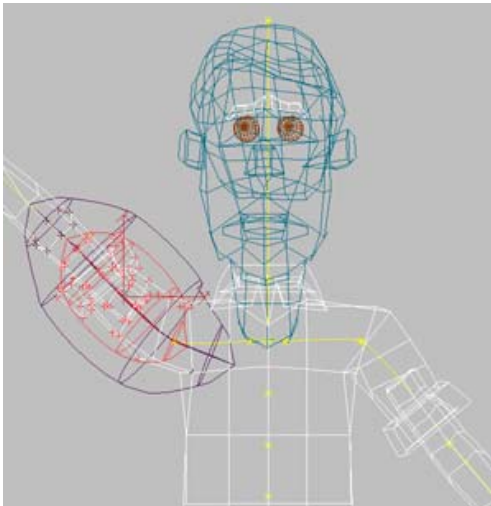

Note: It is possible that the right arm envelope's Radial Scale will have to be increased slightly to encompass the sleeve on that arm. Even with

a symmetrical model, there can be very slight differences between the biped pose on each side, causing differences in the initial envelope size and placement.

Adjust the leg envelopes:

The envelopes for the lower legs don't fully encompass the entire pant leg near the ankle.

1. Select lower right leg link, and increase the Radial Scale.

When you increase the Radial Scale enough to encompass the entire pant leg, the outer envelope includes some of the vertices on the other leg. You will solve this problem by moving control points.

The process of moving control points is easier if you put the character back into its figure pose.

2. In the Display group, turn on Initial Skeletal Pose.

The character jumps back to its figure pose.

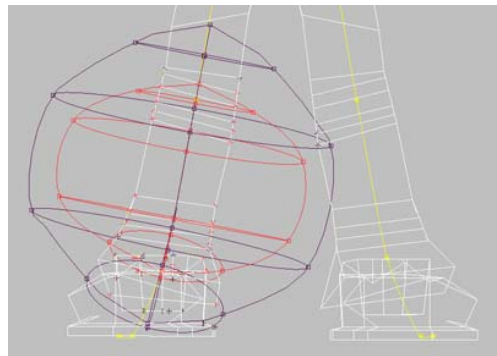

3. In the Blending Envelopes rollout > Selection Level group, click the Control Point button.

Control points appear on each envelope.

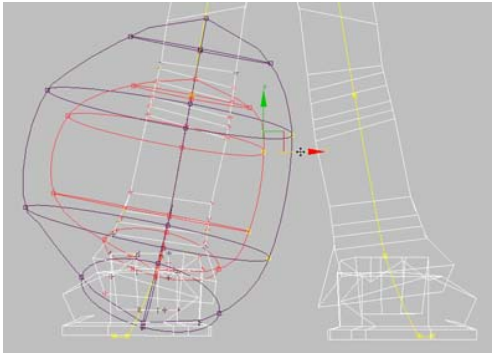

4. In the Front viewport, select the control points on the side of the envelope that overlaps the left leg, and move them to the left until the envelopes no longer affect the left leg's vertices.



5.  In the Blending Envelopes rollout > Selection Level group, click the Link button.
6. Select the lower left leg link. Increase its Radial Scale so the envelopes encompass the entire left pant leg.
7.  Click Control Point.
Control points appear on each envelope.
8. Adjust the control points as you did before, so the lower left leg envelopes don't affect the lower right leg's vertices.

Adjust foot envelopes:

1. Turn off Initial Skeletal Pose.
2.  In the Blending Envelopes rollout > Selection Level group, click the Link button.
3. Select one of the foot links, and increase the Radial Scale until any parts of the foot that were sticking out are now following along with the foot bone.
4. Copy and paste the envelope settings to the other foot, or adjust them manually.

Fine-tune the ankle area:

1. Click the Link button, then click the calf link on the left leg.

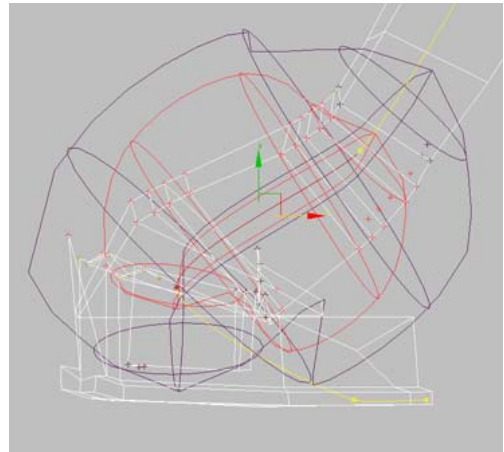

In looking at the pose on frame 10, you can see that parts of the shoe are affected by the calf link, causing spikes to appear on the shoe. You'll fix this problem by adjusting the Child Overlap parameter. This value changes the length of the envelopes in the direction of the child link. In this case, the foot link is the child of the calf link.

2. In the Envelope Parameters group, decrease the Child Overlap setting until the calf envelope no longer affects the vertices at the back of the heel.

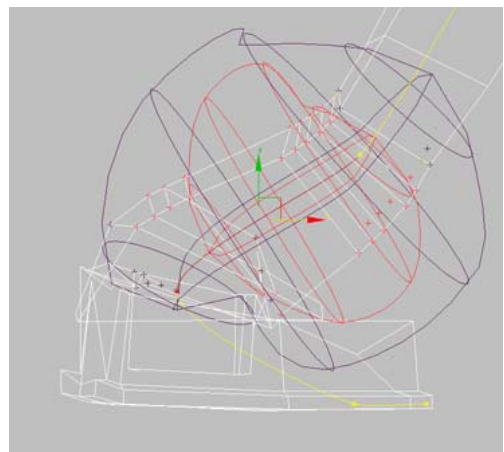

Note: The Parent Overlap parameter works in the opposite direction, increasing or decreasing

the length of the envelopes in the direction of the parent link.

3. Copy and paste the envelope settings to the opposite calf link.

Although the hips are not deforming correctly just yet, the arms and legs should now deform properly without vertices being left behind or making unsightly spikes. If any problems remain, fix them by working with the Radial Scale, Parent Overlap, and Child Overlap parameters.

Assign a rigid envelope to the head:

The head is not expected to deform when the biped is animated. To keep it from deforming, you'll assign rigid vertices to it.

1. Select the character's head mesh, *Wilson Mesh Head*.

Note: Because the Physique modifier is instanced on both the mesh and head, it doesn't matter whether the head, the mesh, or both objects are selected when you adjust the head envelopes. Any changes to envelopes will take place on both objects regardless of the current selection. You select the head at this time only because it will be easier to see how vertices are affected when you change the envelopes.

2. Access the Envelope sub-object level for the Physique modifier.
3. Click the head link to select it.
4. In the Active Blending group, turn off Deformable and turn on Rigid.

Vertices on the head turn green to indicate they are rigid.

5. Adjust the outer envelope so it encompasses the head and a little of the neck, but no more.

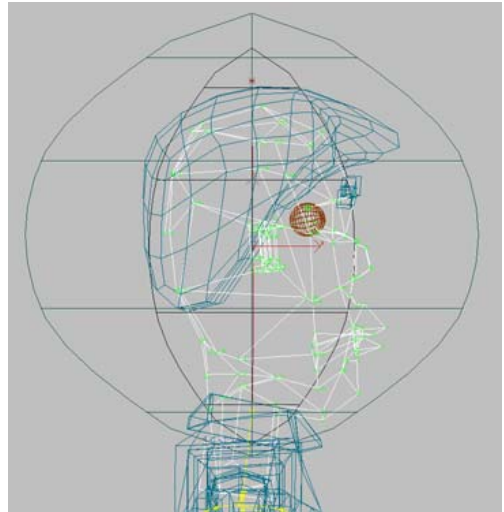

Save your work:

- Save your scene as **my_wilson_envelopes.max**.

A scene with adjusted envelopes can be found in the file *envelopes_wilson_complete.max*.

Fixing Shoulders and Hips

When adjusting Physique envelopes for a mesh, the shoulder and hip areas present the greatest challenges.



Envelopes for these areas must be adjusted carefully to ensure the character moves the way you've envisioned.

An important part of character animation is smooth deformations between joints. For elbows, knees, and other joints with only two adjacent links, this is usually a simple matter of making the outer envelopes overlap slightly at the joint.

However, with shoulders and hips, there are several joints at work in the same area. Making these links work well together is the key to smooth deformation in the hip and shoulder areas.

Set up for this lesson:

1. Load the file *my_wilson_envelopes.max* that you created in the lesson *Adjusting Envelopes* (page 1–400). Alternatively, you can load the file *hips_wilson_start.max* from the CD.



This scene contains the character Wilson. Physique has been applied to the model and some envelope adjustments have been made, but there are still some problems with the hips. The biped has been hidden to make it easier to work with the model.

When fine-tuning envelopes as in this lesson, it's easier to see what's happening if MeshSmooth is applied to the model.

2. Select the body mesh, *Wilson Mesh Body*.
3. On the Modify panel, apply the MeshSmooth modifier above the Physique modifier.

Applying MeshSmooth above Physique means Physique will affect vertices from the lower-poly version of the model. This will retain the ease of adjusting envelopes for fewer vertices, while MeshSmooth will make the final model smooth in appearance.

4. In the Subdivision Amount rollout, change Iterations to 1
5. In the User viewport, zoom in on the hip area.
6. Scrub the time slider back and forth between frames 0 and 10.

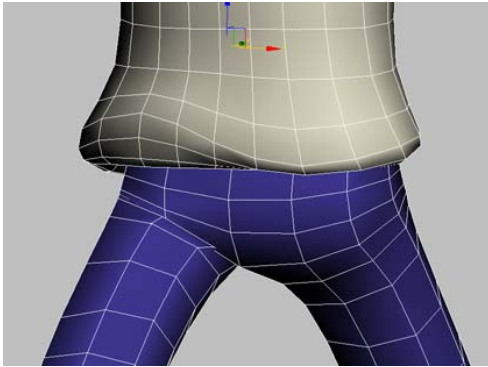

A few problems are apparent with the hip area:

- The bottom of the shirt deforms with the legs.
- The front part of the hip doesn't move with the leg.
- The top of the leg creases a great deal when the leg moves forward.

You'll solve these problems by adjusting the envelopes in the hip area.

Adjust the center hip link:

1. In the modifier stack, choose the Envelope sub-object level under the Physique modifier.
It will be easier to work with the hip envelopes in the initial skeletal pose.
2. In the Blending Envelopes rollout > Display group, turn on Initial Skeletal Pose.
3. In the Front viewport, zoom in on the hip area.
There are three links in the hip area, one in the center of the pelvis and a link to each leg.
4. Select the center link to see its current envelope.

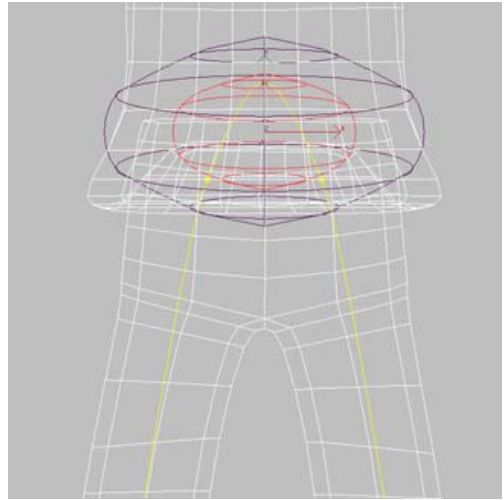

This link should affect vertices that will move very little or not at all when the hips move. For example, Wilson's shirt shouldn't move very much when his hips move, so this link should control the bottom of the shirt.

5. In the Envelope Parameters group, turn on Outer.

This will cause any changes to the Radial Scale, Parent Overlap, or Child Overlap values to affect only the outer envelope.

6. Adjust the Radial Scale and Parent Overlap parameters until the outer envelope encompasses the bottom of the shirt.

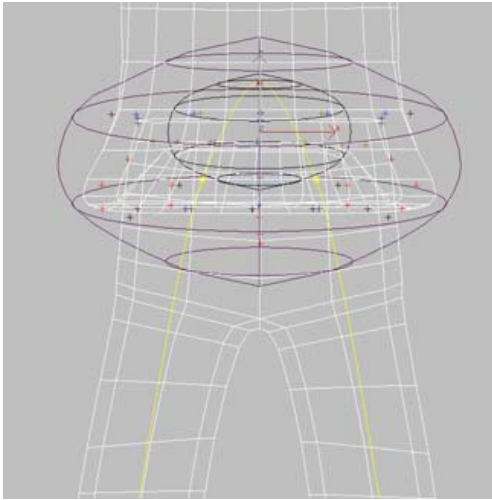

Adjust the hip links:

1. In the Envelope Parameters group, turn on Both.

This will color the envelopes red and purple again so you can clearly distinguish between them in the next step.

2. Select the left hip link to see its envelopes.



This link looks somewhat twisted. This happens because the hip links actually go around a small corner at the top of the link. You can work with this link more easily if you first straighten out the envelopes by decreasing the Parent Overlap value. This slides the envelopes down the link and away from the bend.

3. Reduce the Parent Overlap value until the envelopes straighten out.



Recall that one of the problems in the animation was that the hip was affecting the shirt but not the hip portion of the leg. You'll work further with this set of envelopes to correct this problem.

4. Increase the Child Overlap value to move the envelopes down to the top of the leg.
5. Decrease the Parent Overlap more so the inner envelope just reaches the bottom of the shirt.
6. Choose Inner, and reduce the Radial Scale for the inner envelope to lessen the envelope's effect in this area.

7. Choose Outer, and reduce the Parent Overlap more until the outer envelope just reaches the top of the shirt.

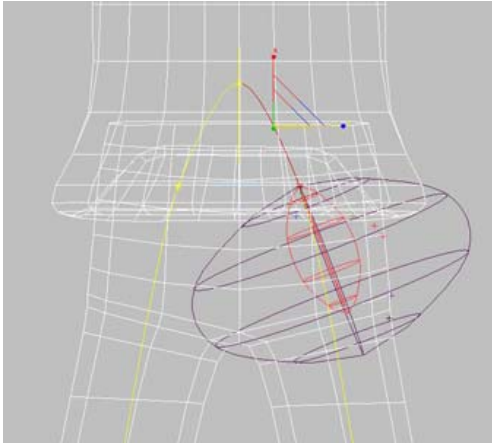

8. Copy and paste this envelope to the other hip.
9. Turn off Initial Skeletal Pose and check the animation on frame 10. The movement of the hips should no longer affect the bottom of the shirt. If it does, make further adjustments to the center link and hip envelopes.

Adjust the leg envelopes:

The leg envelopes also affect the hip area. One of the most common problems is each leg's influence (or lack of influence) on the buttock area.

1. In the User viewport, rotate and zoom the view to show the character's buttocks area.
2. Select each upper leg link, and change the Radial Scale parameter for the inner and outer envelopes to see the effect on the hip area. Adjust the envelopes until the deformation looks smooth and realistic on frame 10.

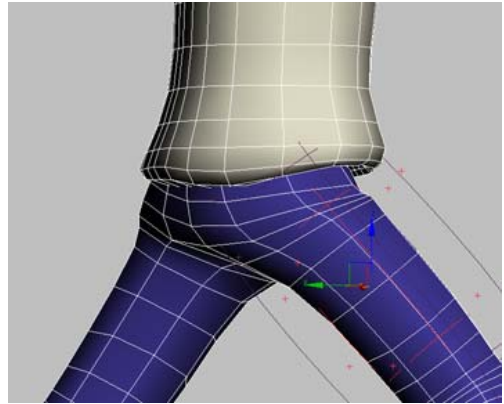

This is perhaps the most challenging step in working with Physique. If you have difficulty with this step, save your work to **my_temp_hips.max**, and load the file *hips_wilson_complete.max* to study the leg and hip envelopes. Then reload *my_temp_hips.max* and try again.

Adjust the shoulders:

When the biped's arms move, the arm, clavicle, and chest bones come together to affect the vertices in the shoulder area.

Ideally, for a human character, envelopes would be adjusted to achieve this setup:

- The chest bone affects all vertices in the chest area, and a few vertices in the armpit area
- The arm bone affects all vertices in the upper arm, and some vertices around the shoulder and armpit area
- The clavicle bone affects all vertices between the neck and shoulder, and some vertices in the shoulder area

To locate problems with the shoulder area, animate your biped to the most extreme arm motions you plan to use in your animation. For example, if you plan to animate the character with its arms swinging by its sides as it walks, you should move

the arm to the character's side and check the deformation in this pose.

For the Wilson character, you'll increase the MeshSmooth iterations to further smooth the model before working with the shoulder areas.

1. Choose the MeshSmooth modifier on the stack. In the Subdivision Amount rollout, change Iterations to **2**.
2. Choose the Physique modifier on the stack. In the Physique Level Of Detail rollout, turn off Hide Attached Nodes to unhide the biped.
3. Go to frame 20 and turn on Auto Key.
4. Move the biped's left hand down until the character's arm is at his side.
5. Work with the clavicle, chest, and arm envelopes until the deformation is smooth.

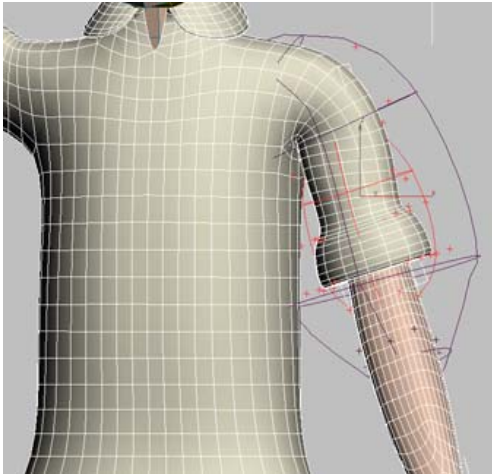

When working on the shoulder, check these links and correct any obvious problems such as:

- Arm bone affects vertices in the chest, causing the chest to cave in when the arm is rotated downward
- Chest bone does not affect the entire chest area

If you have difficulty adjusting the shoulder envelopes, save your work to **my_temp_shoulders.max**, and load the file *hips_wilson_complete.max* to study the leg and hip envelopes. Then reload *my_temp_hips.max* and try again.

Save your work:

The model is now ready to be animated. As you pose the biped in various positions during the animation process, it's not uncommon to find additional small problems with envelopes. You now know enough to correct these problems as they crop up.

1. Select the *Wilson Mesh Head* object, and apply the MeshSmooth modifier to the head with an Iterations value of **1**.
2. Save the file as **my_wilson_hips.max**.

The Wilson model with adjusted shoulder and hip envelopes can be found in the file *hips_wilson_complete.max*.

Rendering

Introduction to Lighting

Lights are objects that simulate real lights such as household or office lamps, the light instruments used in stage and film work, and the sun itself. Adding lights to a scene can help give it a more realistic appearance. If a scene contains geometry but no light objects, 3ds Max provides default lighting. When you add a light object to the scene, the default lighting is *turned off*. Setting up lighting is not difficult, but to do it well, it is a good idea to plan ahead, and to experiment.

How you set up lights for a scene, depends on the purpose of your rendering or animation. Lighting situations fall into two broad categories:

- Lighting a space; for example, an architectural model.

Lighting an outdoor daylight scene is a special case of this, because 3ds Max has special features for daylight. These are demonstrated in *Rendering a Daylight Scene (page 1–448)*.



Lighting an interior space

- Lighting a specific subject; for example, a talking head.

Whether the subject is a character, a still life, or other detail, the principles of lighting are much the same.



Lighting a subject

Skill level: Beginner

Time to complete: 30 minutes

Lighting an Interior Space

To light an interior space, the guidelines are simple: use light objects with realistic values, and place them where you would in the actual building. Photometric lights are preferred for this, but to use photometric lights, it is *essential* that the model have realistic dimensions.

Set up the scene:

- In the `|tutorial|lights` directory, open the file `interior_unfinished.max`.

The scene shows an interior living-room space, with a fireplace and entrance alcove. The walls, floor, and ceiling of the room have been frozen to make them difficult to select accidentally.

Tip: If the walls are hard to see, use `Customize > Customize User Interface > Colors` to make the viewport background a lighter gray.

If you were to render the scene now, you would see a plain, bare room. This is the default lighting from a single light source.



Room rendered with default lights

Add a light with a preset value to the entryway:

1. Choose `Create > Lights > Photometric Lights > Presets > 75W Bulb`.

This creates a light object with a typical wattage.

- In the Top viewport, move the cursor over the alcove, and then click to position the light.

The light is now in the alcove.

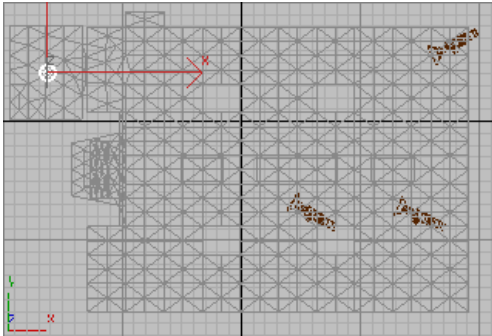

Positioning the alcove light

If you look at the Left viewport, however, you will see that the light is on the floor.

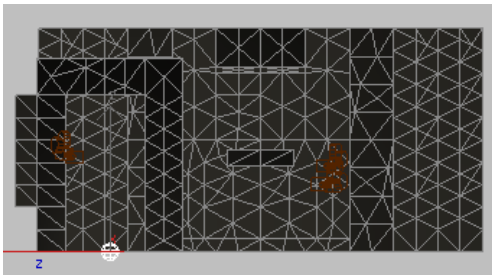

By default, the alcove light is created at the level of the floor.

-  Right-click the Left viewport to activate it. Turn on Move, and then move the new light up to the level of the ceiling.

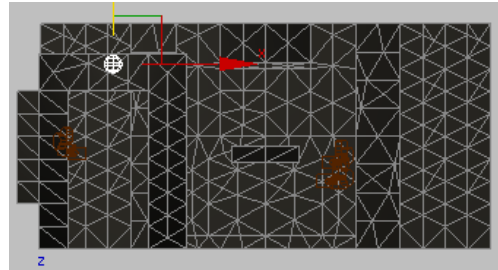

Alcove light moved to ceiling level

If you were to render the scene now, it would be very dim.

Adding a light turns off the default lighting. Once you add a light, all the lighting for the scene must come from light objects that you place yourself. (The rendering also shows what appears to be a bit of a light leak above the door frame. Don't worry about this: it won't be apparent once you add more lights.)

Add an overhead fixture:

For overhead lighting in the living room, you will use a prepared light assembly from a separate MAX file.

-  On the Create panel, turn on Lights. Choose Photometric from the drop-down list, turn on one of the light object buttons, and then turn on the AutoGrid toggle.
- Move or resize your 3ds Max window so you can also see a Windows Explorer window.
- Right-click a viewport and choose Unfreeze All from the Display (upper-right) quadrant of the quad menu.

AutoGrid doesn't work well when the geometry is frozen.

4. Drag the file *ceiling.pendant.max* from the *tutorial\lights* directory onto the Camera02 viewport in the 3ds Max window.

A pop-up menu appears, giving you the choice of opening, merging, or cross-referencing the scene with the ceiling pendant.

5. Choose Merge File.

The ceiling pendant geometry appears. It is selected and because of AutoGrid, it is aligned to faces in the scene.

6. Drag the light fixture until it is aligned with the ceiling, and move it to a position near the fireplace.

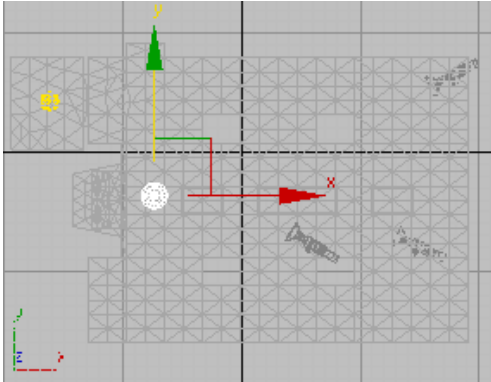

Top plan position of the ceiling pendant fixture

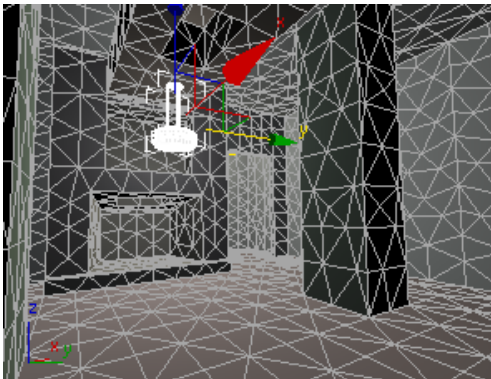

Camera view of the pendant light

Now that you have a single light in the living room, you can make instances of it to provide the room with more light.

Freeze the room again:

1. Click to select the room object (*Box01*).
2. Right-click a viewport and choose Freeze Selection from the Display (upper-right) quadrant of the quad menu.

This keeps you from selecting and moving the entire room, when you are trying to clone the light fixture.

Make an array of light instances:



1. Activate the Top viewport and turn on Move.
2. While holding down the SHIFT key, move the light to the right along the X axis. (Watch the Camera02 viewport so the light ends up hanging from the ceiling, and not from the skylight.)

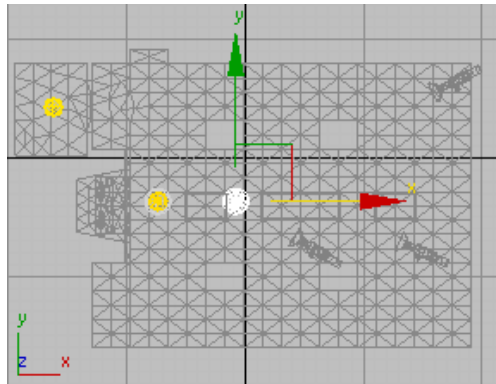

Top plan position of the first cloned light

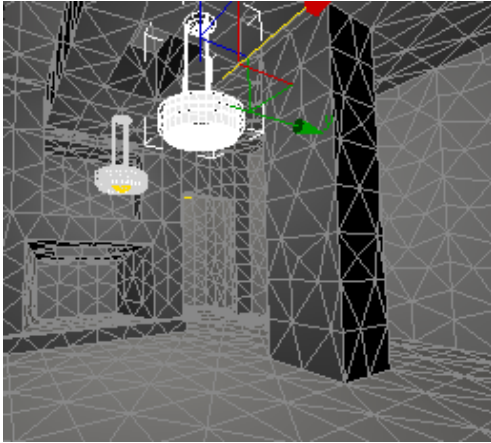

Camera view of the first cloned light

The Clone Options dialog appears.

3. In the Object group, choose Instance, and then click OK.
4. Repeat steps 2 and 3 two more times, so you have a row of four light fixtures.

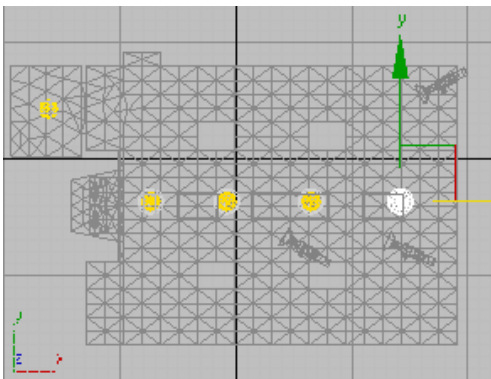

The first row of cloned lights

5.  On the toolbar, make sure that the Window/Crossing toggle is set to Window, then drag in the Top viewport to select all four lights.
6. While holding down the SHIFT key, drag the four lights up along the Y axis to add another row, near the far wall.

The Clone Options dialog appears.

7. Make sure Instance is still chosen, and then click OK.

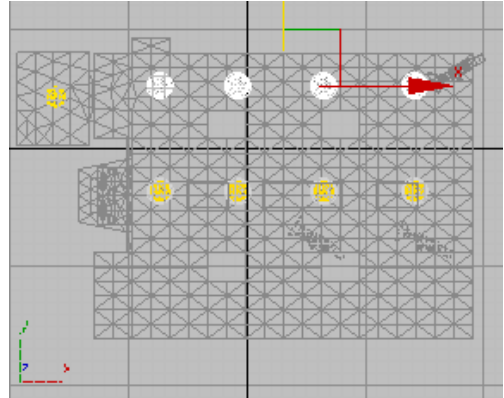

Top plan view with two rows of ceiling lights

Render the scene:

-  On the main toolbar, click Quick Render.

3ds Max renders the room.



Room lit by all lights (direct lighting only)

Now the living room is illuminated, and you can see the colors on the walls. It still looks rather shadowy, but this is only because the rendering shows direct light only. In real life, objects are illuminated by both direct light and reflected (“bounced”) light. In 3ds Max, you

can add reflected light by calculating the scene's radiosity.



Room with radiosity calculated to provide bounced (indirect) light as well as direct light

The radiosity solution shows that in fact, you might want to turn down the level of the living-room lights before making a final rendering. Radiosity is demonstrated in the *Advanced Lighting and Global Illumination tutorial (page 1–437)*. The lesson that follows, *Managing Multiple Lights (page 1–419)*, shows some ways to manage an array of instanced light objects such as those you just created.

Save your work:

- Save the file as **room_with_lights.max**.

Note: The scene *interior_with_lights.max* contains the completed version, and the scene *interior_with_lights_and_radiosity.max* contains both the completed version and a radiosity solution.

Summary

These are the main points of this lesson:

- If the model is to scale, use photometric lights.
- If you are lighting an indoor scene, position the lights and fixture assemblies as you would in the actual building, and use radiosity to model bounced light.

See *Advanced Lighting and Global Illumination (page 1–437)* for a demonstration of radiosity.

Outdoor lighting is a special case. See *Rendering a Daylight Scene (page 1–448)*.

Lighting a Close-Up of a Head

To light a subject, such as a talking head or a still life, it helps to think in terms of how you would light the same subject if you were working on a stage set or in a photo studio. In other words, you can place the lights wherever you want, adjust their intensity, tint their color, and so on. There are some widely used guidelines to lighting this way, and this section introduces them briefly.

Note: As with architectural lighting, you can use photometric lights, but they do the job only if the scene has been modeled to a real-world scale. In this exercise, you will use Standard lights to simulate a 3-point lighting scenario like they do in photo studios and television sets.

Set up the scene:

- In the `ltutorial\lights` directory, open the file `pito_head_shot.max`.
The scene has a camera that is set up to render a head shot of the 3D cartoon character named Pito.

Look at the default lighting:

-  On the main toolbar, click Quick Render. 3ds Max renders the camera view.



Default lighting of Pito

This is not a bad rendering of Pito, but we can do better.

Add a light:

1.   On the Create panel, turn on Lights, and then click Target Spot to turn it on.
2. In the Top viewport, drag from the bottom left corner of the viewport to create a light that is aimed at Pito's head.

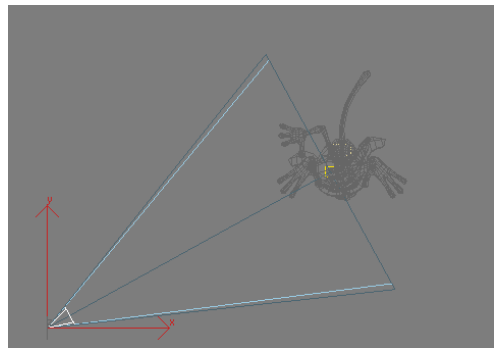

Aiming a target spot light at Pito

3ds Max creates the light. However, it is at ground level.

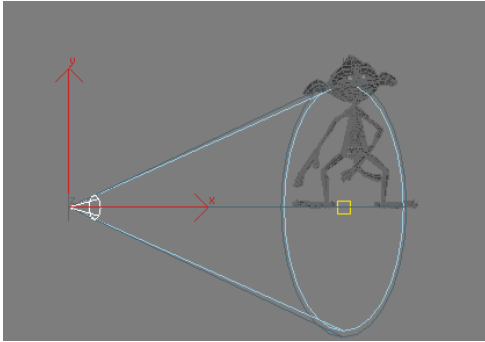

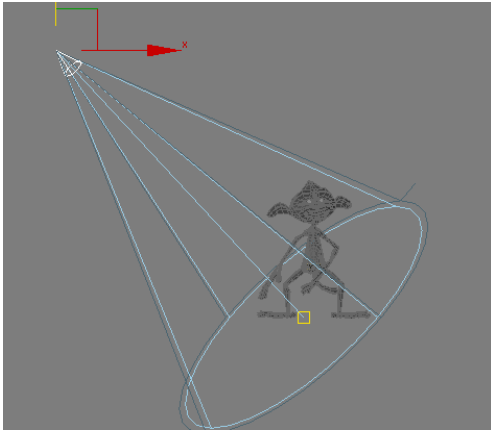

Light is created initially at ground level.

3.  In the Front view, use the Move tool to move the spotlight so that it is slightly higher than Pito's head.

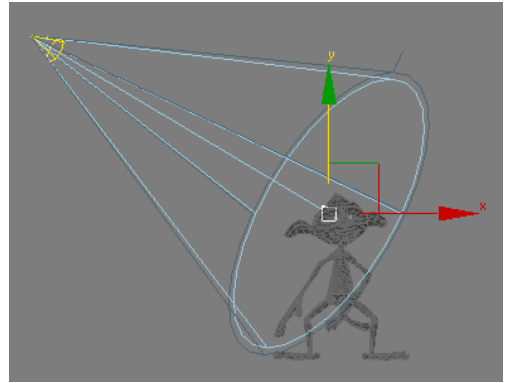

4. Select the spotlight target (small yellow square) and move it up to Pito's eye level.



5. Select the spotlight again (the yellow cone).
 Go to the Modify panel, and on the General Parameters rollout, turn on Shadows. (The default method of Shadow Map will work fine.)
6. In the Intensity/Color/Attenuation rollout, set the Multiplier value to 1.5 to increase the light's intensity.

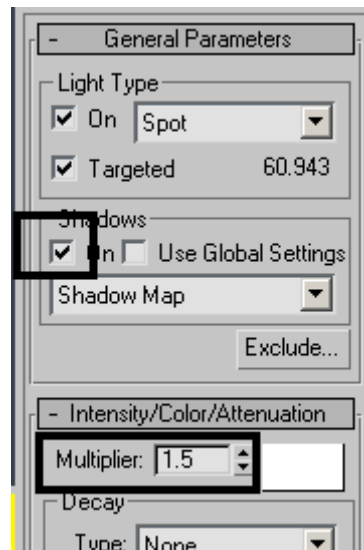

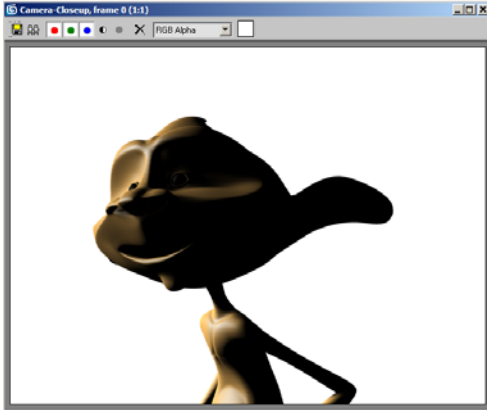

7.  Right-click the Camera view to make it current, and then click Quick Render.



We can see that Pito is illuminated on one side, but the shadow areas are too dark. In general, faces look better and more interesting if they are lit at an angle, but one has to compensate with a fill light to get rid of the dark areas. This is why flash photos usually don't look as good as studio portraits.

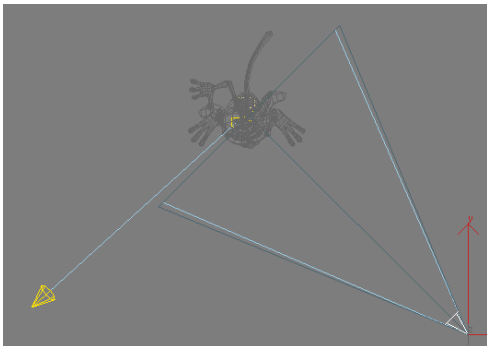

Add a fill light:

1.   On the Create panel, turn on Lights, and then click Target Spot to turn it on. In the Top viewport, click and drag to create a target spot on the right side aiming at Pito. The two lights can form about a 90-degree angle with Pito's face.

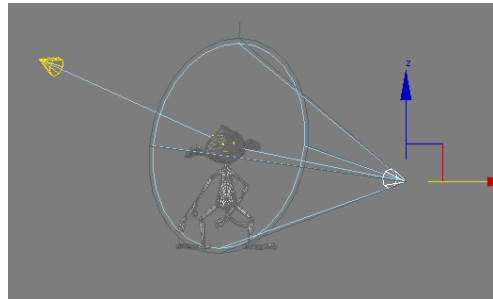

2. In the Front view, move the fill light and its target to about Pito's eye level.



3.  In the Modify panel, set the Fill light's multiplier value to about 0.6. A fill light is usually less intense than a main light as its purpose is to simulate global illumination (bouncing light).
4.  Make the Camera view current, and then click Quick Render.



Here is a good, balanced portrait of Pito. Compared to the default light, it is brighter and you can see more detail, but there are shadows enough to make Pito look three dimensional.

Add a Back Light

A back light's sole purpose is to separate the character from the background. It is a light you place behind the character to emphasize the silhouette against the background. This can be especially useful when shooting a dark-haired character against a dark environment.



1. On the Create panel, turn on Lights, and then click Target Spot to turn it on.
2. In the Left viewport, drag from above and to the left of the character to create a light that is aimed at Pito's head.

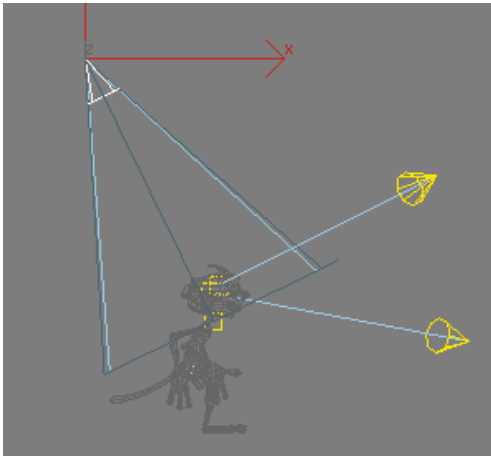

3. With the back light selected, go to the Modify panel and notice that the back light's intensity retained the Multiplier value of 0.6 used on the last light in the scene. Set the Multiplier value to 0.4 as a back light is typically the least intense of all lights in a scene.
4.  Make the Camera view current, and then click Quick Render.

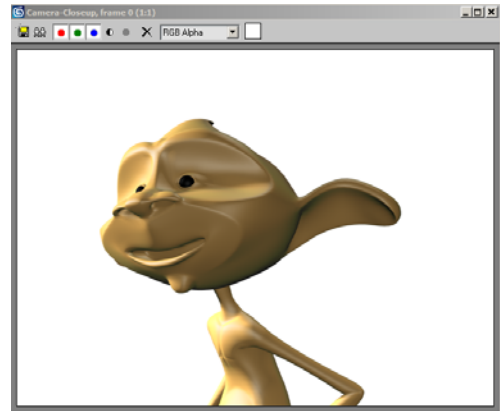

The brighter light, which you created first, is known as the key light. The dimmer light, which you added next, is known as the fill light. For most subjects, you want to have a single key light only, but you can add additional fill lights to illuminate the background or other hard-to-see places to simulate global illumination. You can also vary the position of the key light, to make the image clearer or more dramatic. Finally, you added a back light to separate your character from the background.

Experiment:

The best way to understand how an individual light is affecting your scene is to turn off all other lights that are present. Try this:

1.  Select the Main light (the first light you created) and in the Modify panel, turn the light temporarily off.

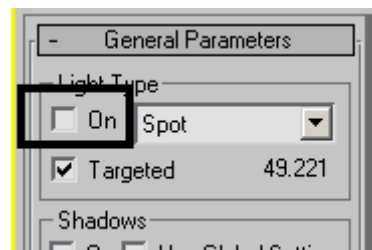

- Repeat the procedure with the Fill light (the second light you created).



- With the Camera view current, click Quick Render.

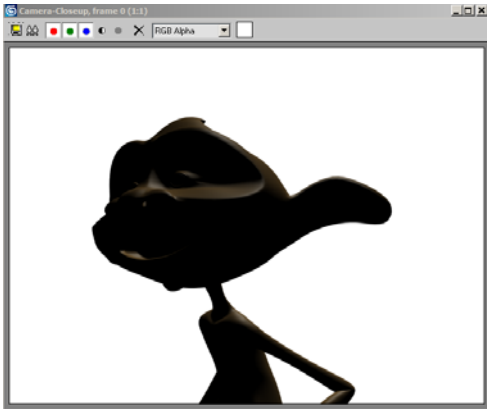

You can now see the individual effect on the back light in the scene.

- Experiment by turning off or on the three lights you created. When you are done, turn all three lights back on before saving your file.



The effects of the individual lights on Pito: the Main light (Left), Fill Light (Center) and Back light (Right).

Save your work:

- Save the scene as **pito_lit.max**.

Note: The 3-point light version of the scene is in *pito_head_shot_final.max*.

Summary

If you are lighting a single subject such as a head, use a single key light and one or more fill lights.

The key light is the brightest; the fill lights have a lower intensity.

You can get different effects by changing the angle of the light. Avoid lighting a subject directly from the front.

Managing Multiple Lights

Interior architectural models typically have a large number of light objects. This lesson demonstrates some ways to manage lights, both when they are instanced, and when they are not.

Managing Instanced Light Objects

In architectural modeling, it's common to use instanced lights. Instancing allows you to control the properties of all lights of a particular type by editing the properties of just one of them. However, you sometimes want to control lights individually. This section shows you how.

Set up the scene:

- In the *|tutorial|lights* directory, open the file *instanced_light_array.max*.

The scene shows a row of six light fixtures and standard free spotlights, aimed at a wall. The lights are instanced.

Render the scene:





- On the main toolbar, click Quick Render.



Wall illuminated by instanced light objects

Turn off one light:

1.   Click to select the leftmost light (*Fspot01*), and then go to the Modify panel. On the General Parameters rollout, in the Light Type group, click the On toggle to turn it off.
2. Click Quick Render.

*Turning off an instance*

Because the lights are instanced, turning off a single light turns off all of them at once.

Hide some lights:

1. On the Modify panel, turn *FSpot01* back on.
2.  On the main toolbar, click Window/Crossing to choose window selection, and then in the Camera01 viewport, drag a selection window to select the leftmost three lights and their fixtures.

Tip: If the toggle is set to Crossing, then you might select the box object as well. Avoid this.

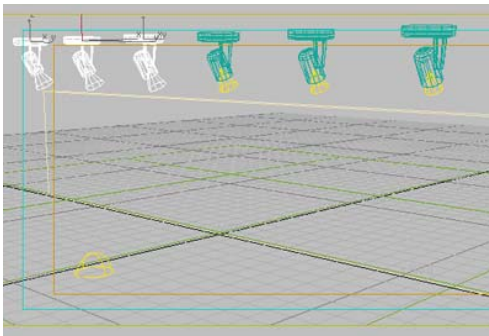
*Lights and fixtures selected*

3. Right-click, and choose Hide Selection from the Display (upper-right) quadrant of the quad menu.

The lights are now hidden.

4. Click Quick Render.

*Rendering hidden lights*

Although the lights are hidden, they still illuminate the wall. Hiding a light has no effect on its light-casting properties.

Turn off some lights by making them nonrenderable:

1. Right-click the Camera01 viewport, and choose Unhide All from the Display quadrant.
2. Use click and CTRL+click to select the leftmost three lights, but *not* their fixtures.

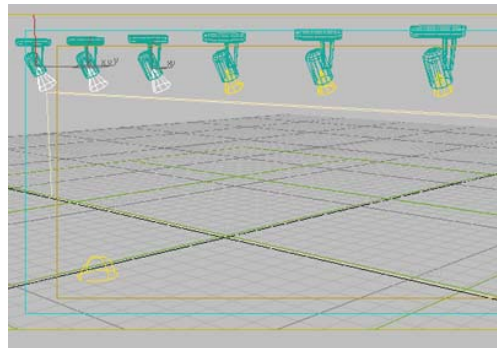
*Light objects selected, but not their fixtures*

3. Right-click again, and choose Properties from the Transform (lower-right) quadrant of the quad menu.

The Object Properties dialog is displayed.

- On the General panel, in the Rendering Control group, turn off the Renderable toggle.
- Click Quick Render.



Lights turned off using the Renderable property

Now you have the desired result. The Renderable toggle can control whether an instanced light casts light in the scene.

Save your work:

- Save the scene as **render_toggle_light_array.max**.

Using the Light Lister

The Light Lister tool is a sort of master dialog for lights in the scene. For individual lights, it is a shortcut to controls on the Modify panel. (Its General settings also include settings on the Environment panel.)

Set up the scene:

- In the `!tutorial/lights` directory, open the file `light_array.max`.

The scene is the same as in the previous section, but in this case, the lights are independent objects, not instances.

Use the Light Lister to dim some lights:

- Choose Tools > Light Lister.

The Light Lister dialog is displayed. There is an entry for each unique light in the scene (instances don't appear on this dialog).

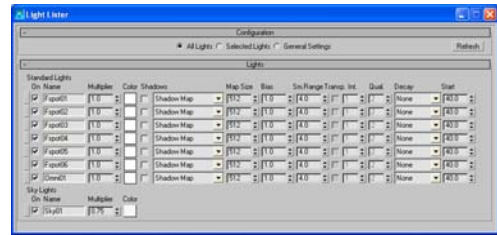

You might have to expand the dialog vertically to see all the rows. As the dialog shows, the scene contains six free spotlight objects, one omni light, and one skylight.

Note: The Light Lister cannot control more than 150 unique light objects at a time. If there are more than 150 unique lights in your scene, the Lister displays controls for the first 150 it finds, and a warning that you should select fewer lights. Select fewer lights and then use the Selected Lights configuration.

- Change the Multiplier value to equal **0.3** for all the free spotlights except the fifth one (`Fspot05`). Leave the Multiplier for `Fspot05` set to 1.0.

Tip: You can use the standard Windows **CTRL+C** and **CTRL+V** to copy and paste values from one spinner field to another.

- Click Quick Render.



Only the fifth light casts a full-strength beam.

Use the Light Lister to change light colors:

- On the Light Lister, change the Multiplier value for all the free spots back to **1.0**.

- Click the color swatch for the second light, *Fspot02*.
The Color Selector is displayed.
- Change the color of the second spotlight to a light gold: R=255, G=191, B=52. Then click OK.
- On the Light Lister, drag the *Fspot02* color swatch to the *Fspot04* color swatch.
A Copy Or Swap Colors dialog is displayed.
- Click Copy.
- Drag the *Fspot04* color swatch to the *Fspot06* color swatch. Once again, click Copy when prompted to copy or swap colors.
- Click Quick Render.



Now alternating lights have alternating color.

Save your work:

- Save the scene as **light_array_with_color.max**.

Summary

- To control whether a light instance casts a beam, you can use the light object's Renderable property, which is set from the [Object Properties dialog](#).
- The [Light Lister](#) is a convenient overall "console" for adjusting lights in your scene.

Both photometric and standard lights use shadow-mapped shadows by default. 3ds Max offers some alternate ways to generate shadows, as this lesson demonstrates.

Set up the scene:

- In the `|tutorial|lights` directory, open the file *shadows.max*.

The scene is a classical sculpture against a plain white background. It is lit by three omni lights, but only one of them, *Omni01*, is shadow-casting.



Render the scene:

-  On the toolbar, click Quick Render.



The statue's shadow is shadow mapped. It has a fairly sharp-edged outline.

Create a soft-edged shadow:

-   On the main toolbar, click Select By Name. Use the Select Objects dialog to select *Omni01*, and then go to the Modify panel.
- Open the Shadow Map Parameters rollout. Change the value of Sample Range to **10.0**.
- Click Quick Render.



The edge of the shadow is softer. Shadow-mapped shadows can have soft edges, but ray-traced shadows cannot.

Use a ray-traced shadow:

1. On the General Parameters rollout, in the Shadows group, choose Ray Traced Shadows from the drop-down list.
2. Click Quick Render.



This time the shadows are very hard edged.

Note: 3ds Max offers two kinds of ray-traced shadows: Advanced and “regular.” The advanced option has more ways to adjust shadow quality; otherwise, their behavior is similar.

Make the shadow lighter:

1. On the Shadow Parameters rollout, in the Shadow Parameters group, change the value of Density to **0.4** (equivalent to 40 percent).
2. Click Quick Render.



The shadow is now lighter. Options on the Shadow Parameters rollout are independent of which kind of shadow you are generating.

Use an area shadow:

1. On the Shadow Parameters rollout, change the value of Density back to **0.85**.
2. On the General Parameters rollout, in the Shadows group, change the shadow type from Ray Traced Shadows to Area Shadows.
3. Open the Area Shadows rollout, which is now displayed. In the Basic Options group, make sure that Rectangle Light is chosen. In the Area Light Dimensions group, change the Length and Width to both equal **5.0**.
4. Click Quick Render.



This time the results are even more diffuse than a soft-edged shadow-mapped shadow. Area shadows simulate shadows cast by an area of light, such as a window or skylight, rather than from a point source like a spotlight.

Tip: Photometric lights also provide true area lights and linear lights.

Save your work:

- Save the scene as **my_area_shadow.max**.

Summary

Photometric and standard lights both have the same options for generating shadows. The main choices are shadow-mapped (the default), ray-traced, or area. Shadow-mapped shadows can have a soft edge; ray-traced shadows are always sharp edged; and area shadows are diffuse, simulating shadows cast by a light-emitting area.

Each kind of shadow generator has its own settings. The settings not demonstrated in this lesson are mainly for adjusting shadow quality. They are described in the *User Reference*.

Introduction to Rendering

To view the final results of your work in 3ds Max as a two-dimensional image or movie, you render the scene. By default, when you render, the software produces a still image at a specific resolution using the default scanline renderer, and displays it in a separate window on the screen. But a wide variety of rendering alternatives is available, and this tutorial will introduce you to some of them.

Skill level: Basic

Time to complete: 2 hours.

Features Covered in This Tutorial

In this tutorial, you will learn how to:

- Render a still image to the screen and to a disk file in different formats and resolutions
- Use different renderers and presets.
- Render a high-resolution image using multiple computers.
- Render an animation and combine still images into a movie file.
- Use a network farm to simultaneously render different images from an animation.
- Use rendering to create textures for use in games.

Tutorial Files

All the necessary files to do the tutorials can be found on the Tutorial Files CD, in the *tutorials\intro_to_rendering* folder, unless otherwise specified. Before doing the tutorials, copy the *tutorials* directory from the CD to your *[3dsmax8]* local installation.

Rendering Still Images

In some ways, 3ds Max is like a photography studio. You arrange and manipulate three-dimensional objects, lights, and a camera, with the ultimate goal of producing an image that illustrates your message. The act of creating that image is called *rendering*. In this lesson, you'll learn some of the different ways you can use 3ds Max to render.

Set up the lesson:

- On the File menu, choose Open and navigate to the `tutorials\intro_to_rendering` folder. Highlight `rendering_still_images_start.max` and click Open.

The scene contains a textured model of an apple, plus a shadow-casting spotlight, a fill light, and a ground plane.

Render the scene:

1. Make sure the Perspective (lower-right) viewport is active; that is, it has a yellow border. If not, right-click anywhere inside the Perspective viewport.

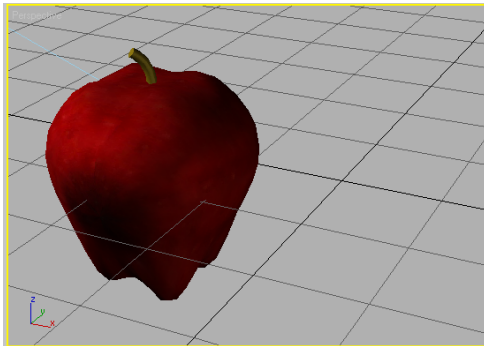

2.  Press **F9** or click Quick Render on the toolbar to render the viewport.

In a few moments, a default rendering of the apple scene appears on the screen.

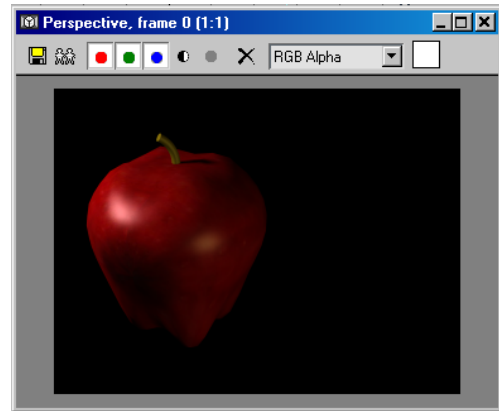

This rendering has several characteristics, all of which you can change:

- It appears in the *rendered frame window*. The text in this window's title bar tells you that you're currently viewing frame 0 as rendered from the Perspective viewport, and the window is displaying the image at a zoom ratio of 1:1, or normal magnification.
 - Its resolution is 320 pixels in the horizontal dimension and 240 pixels in the vertical dimension, or 320 x 240 for short.
 - It uses the *default scanline renderer*. This is the renderer that most 3ds Max artists employ, but others are available. One of these is mental ray, a powerful renderer that is included with the software. You'll take a quick look at mental ray shortly.
3. Close the rendered frame window by clicking the X button in its upper-right corner.

The most efficient way to work with 3ds Max is to use keyboard shortcuts whenever possible. The default shortcut for the Quick Render command is easy to remember.

4. On the keyboard, press **SHIFT+Q**.

The scene is rendered again, exactly the same as before.

Use the rendered frame window tools:

The rendered frame window has a number of tools you can use to work with the image and view it in different ways. Most of these are available as buttons in the toolbar, which is highlighted in the illustration above. In this procedure, you'll try out a few of the other, mouse-related functions. You'll find detailed descriptions of all of the controls in the [Rendered Frame Window topic](#).

1. Click in the window to activate it, and then rotate the mouse wheel forward and back.

If you're not using a wheel mouse, you can zoom the window by pressing and holding the CTRL key and then clicking the left mouse button to zoom in, or the right mouse button to zoom out.

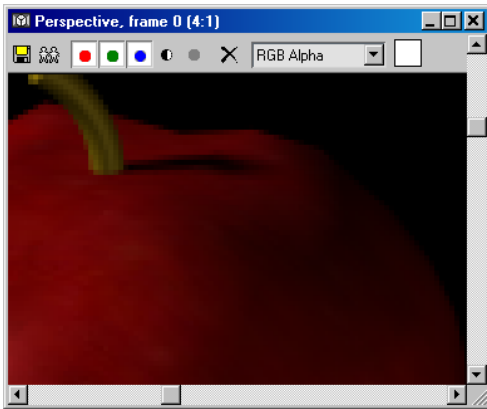

The rendered frame window zoomed in

This zooms the image in and out about the mouse cursor position. The current zoom ratio appears at the right end of the text in the window title bar. You can zoom between 1/8 and 64 times actual size.

You can change the window size using standard Windows methods, such as by dragging the lower-right corner.

2. When zoomed in, you can pan the image by pressing and holding the middle mouse button

(or wheel button), and then dragging in the window.

If you're not using a three-button mouse, pan the image by pressing and holding the SHIFT key and the left mouse button, and then dragging in the window.

3. Return to the 1:1 zoom ratio, and then, without holding down any keys, right-click and hold in the image portion of the window.

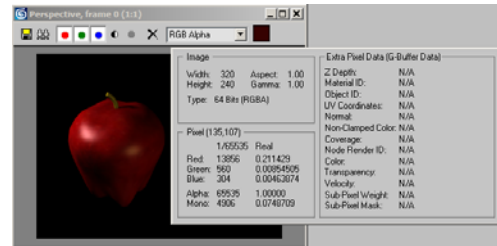

A temporary window appears, showing general image data such as the resolution, as well as specific information about the pixel currently under the mouse cursor.

4. Still holding down the right mouse button, drag the mouse so that the cursor is over a lighter part of the image, such as the specular highlight on the apple.

The color swatch at the right end of the toolbar changes visibly to a light red color. This color remains when you release the mouse button.

5. Close the rendered frame window.

Render with a different keyboard shortcut:

Did you notice that the apple is off-center? There are different ways to fix this; you'll do so by moving the apple. You'll also learn about using the Render Last command.



1. On the toolbar, click the Select And Move button, and then move the mouse cursor into the Top viewport.

- Position the mouse cursor over the apple (the round, wireframe object), press and hold the left mouse button, and then drag slowly to the right. As you drag, watch the apple in the Perspective viewport. When the apple is near the center of the viewport, release the mouse button.

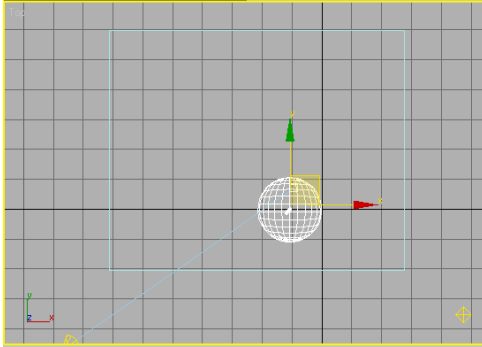

Because you were working in the Top viewport, it is now the active viewport.

- Render the image by pressing **SHIFT+Q**.

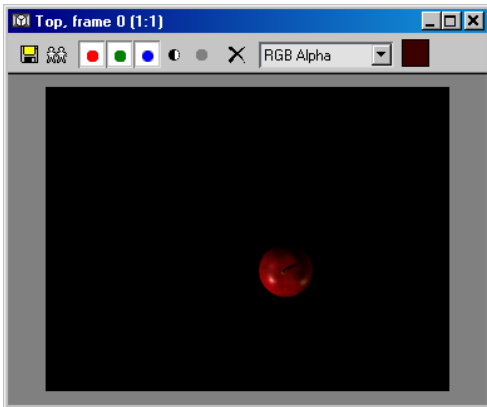

The program renders the view from the Top viewport. The Quick Render command always renders the active viewport. However, you probably wanted to see the Perspective-viewport image. This is a common error in 3ds Max. Fortunately, the program offers a way around it, called Render Last.

- Activate the Perspective viewport and render again.

The new image replaces the previous one in the rendered frame window.

- Close the rendered frame window.
- Activate any other viewport, and then press the key.

This executes the Render Last command, which renders the same viewport that you rendered most recently in the current session, no matter which viewport is active. It's not available from the toolbar, but if you remember the keyboard shortcut, you can save time when working in different viewports.

- Press **CTRL+Z** to undo the apple move. You might need to press it more than once.

Explore rendering options and presets:

In this procedure, you'll try a couple of options for rendering objects that don't normally appear. The scene you loaded contains a hidden object and an object that faces away from the camera. Neither has shown up in the renderings so far.

- Press **F10** to open the Render Scene dialog.

The dialog opens to the Common tab. Available here are controls for changing output size, rendering to disk, and more. You'll look at some of these shortly. Right now, we're interested in the rendering options.

- In the Options group, turn on Render Hidden Geometry.

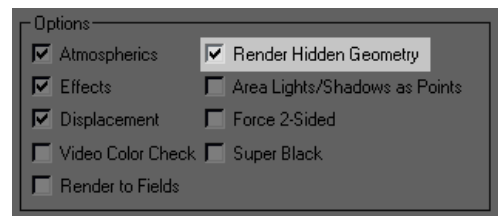

3. Render the Perspective viewport. If the Perspective viewport is active, you can do this by clicking the Render button at the bottom of the dialog. If a different viewport is active, first choose Perspective from the drop-down list to the left of the Render button.

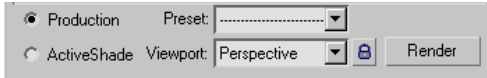

A second, green apple appears in the rendered image. If your scene contains objects that you want to appear in the rendered image but not in the viewport, you can hide them, and then use this option when rendering.

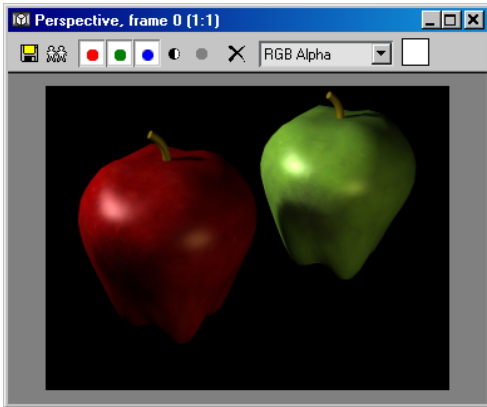

4. In the Options group, turn on Force 2-Sided.

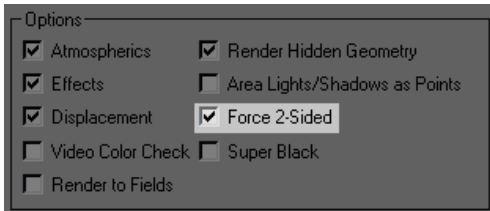

5. Render the Perspective viewport again.

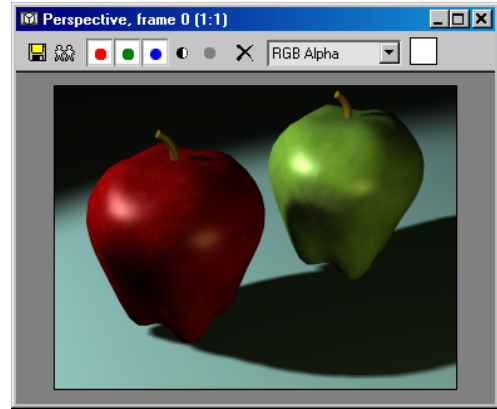

The ground plane appears in the rendering, with the apples casting shadows on it. This object isn't hidden, but because it's facing away from the "camera," it doesn't normally show up when you render. This option is a handy way to make sure all objects in the scene show up in the rendered image, no matter which way they're facing.

A handy feature in 3ds Max lets you save a custom rendering setup as a preset for use with other scenes. You'll try it now.

6. At the bottom of the Render Scene dialog, click the Preset drop-down list, and then choose Save Preset.

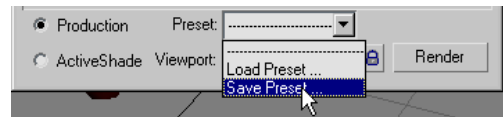

The Render Presets Save dialog appears.

7. Enter **Hidden+2-Sided**, and then click Save.

The Select Preset Categories dialog appears, with a list of the different tabs on the Render Scene dialog. You can store any combination of tab settings in a preset. By default, all are highlighted, but for this exercise, you're interested in saving only the settings on the Common tab.

- Click **Common**, the first item in the list, and then click **Save**.

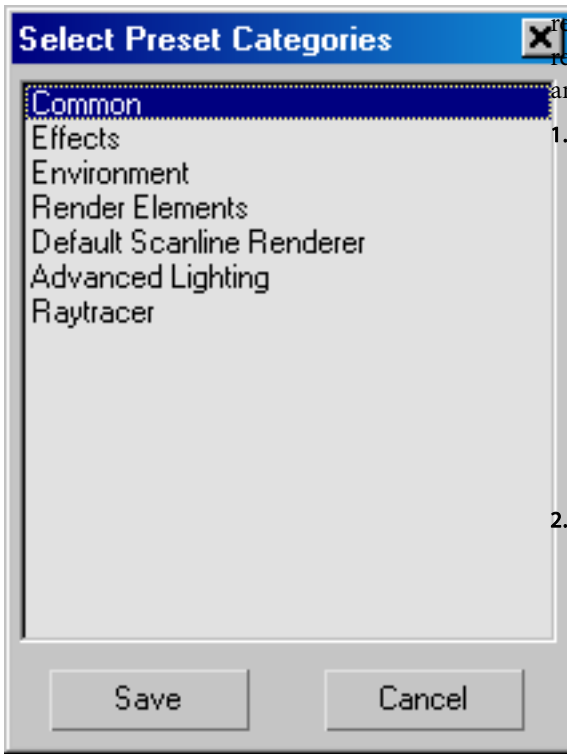

The preset is saved, and then appears in the Preset list.

- In the **Options** group, turn off both **Render Hidden Geometry** and **Force 2-Sided**.
- Click the **Preset** list, and then choose the **Hidden+2-Sided** item.

The **Select Preset Categories** dialog appears, showing only the **Common** item. If you save a preset with multiple tabs, you can choose specific ones for selective loading.

- Click the **Load** button.

The software loads the preset, and according to its settings, turns on both **Render Hidden Geometry** and **Force 2-Sided** again.

Change the output size:

Until now, you've been rendering to the screen at a relatively small size: 320 x 240. 3ds Max lets you render at any size up to 32,768 x 32,768, however, and in a number of different file formats.

- Still on the **Render Scene** dialog, in the **Output Size** group, click the **640x480** button.

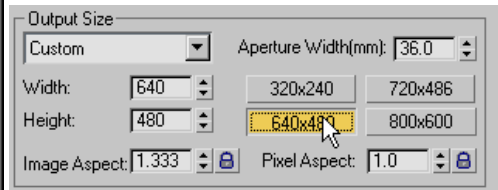

The new output resolution appears in the **Width** and **Height** fields.

- Render the **Perspective** viewport.

The software renders the image at the new, larger size. It takes a bit longer, but is much easier to see.

The **Image Aspect** value, below the **Width** and **Height** fields, is currently 1.333. This is the ratio of width to height. You can alter it by changing one of the dimensions.

- Increase the **Height** value to **640**.

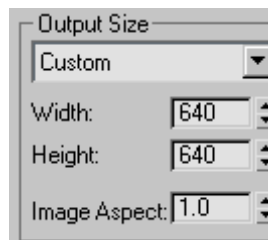

The **Image Aspect** is now 1.0, which means that the width and height are the same, resulting in a square image.

- Render the **Perspective** viewport.

The software divides the added height evenly between the top and bottom of the image, so

there are now 80 additional pixels both above and below the original image.

Tip: When rendering to nonstandard aspect ratios, the Safe Frame option helps you preview exactly how the final render will appear. Right-click the viewport label (“Perspective”), and then choose Show Safe Frame from the menu. The outer frame shows you the area that will render; the others are used when creating video content.

You can also change the dimensions by adjusting the Image Aspect value; this always affects only the Height value. If you try it now, be sure to set Image Aspect back to 1.0 when you’re done.

You can lock the aspect ratio so that changing one dimension automatically adjusts the other.

- Click the lock button to the right of the Image Aspect field.
- Set the Height value to **480**.

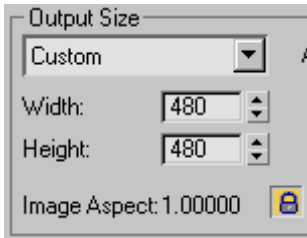

Both Height and Width change to 480.

- Render the Perspective viewport.
- The output image is still square, but smaller.

Change the output location:

Until now, you’ve been rendering only to the screen. In this procedure, you’ll learn about rendering to a disk file, and find out how to turn off screen output.

- In the Render Output group, near the bottom of the Common Parameters rollout, click the Files button.

The Render Output File dialog appears.

- If necessary, change the output location to `|3dsmax8|images|`.

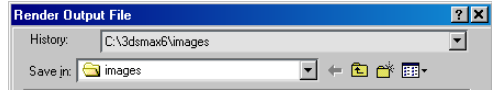

- Click the drop-down-list next to Save As Type, and choose BMP Image File (*.bmp).

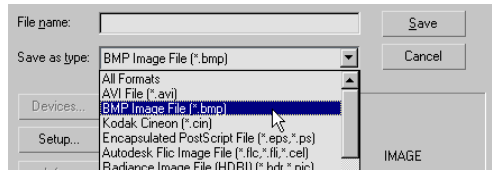

This is the Windows Bitmap file format, commonly used for image files in Windows.

- Click in the File Name field, and type **apples**. Press the ENTER key.
- The BMP Configuration dialog appears. Accept the default choice of RGB 24 bit by clicking OK.

The dialog closes. Nothing has rendered yet, but in the Render Output group, Save File is now available and enabled, and the read-only below it shows the output path and file name. These features become available only after you specify file output properties with the Files button.

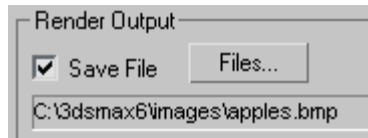

- Render the Perspective viewport using any of the methods you’ve learned so far.

The software renders the image to both the rendered frame window and the specified file. You can see the latter with the View Image File command.

- From the File menu, choose View Image File. Use the View File dialog to open the *apples.bmp* file.

A new window opens showing the rendered image. It's exactly the same as the rendered frame window, except that its title bar shows the name of the file rather than the rendered viewport.

- Close both windows.

The software automatically appended the *.bmp* filename extension when you specified the file type. You can also specify the file type explicitly by including the extension in the file name.

- Click the Files button again, and change Save As Type back to All Formats (at the top of the list). Then change the file name to **apples.tga**. Press ENTER.
- The software recognizes that you want to render the image in Targa format, and displays the Targa Image Control dialog. The Targa image format supports the alpha channel, which allows transparency effects when compositing the rendered image.
- Click the OK button to accept the Targa image defaults.
- Near the bottom of the Render Output group, turn off Rendered Frame Window.
- Render the Perspective viewport.

The software renders the image to the specified file, but not the rendered frame window. You can see the Targa image file with the View Image File command.



If you click the Display Alpha Channel button on the window toolbar, you can see a tiny bit of transparency (black) in the

upper-right corner. This is where the ground plane ends, showing the background, which is usually transparent.

- Close the image window.

Use a different renderer:

Included with 3ds Max is a powerful, sophisticated renderer called mental ray. Full exploitation of its capabilities is beyond the scope of this tutorial, but basic usage is straightforward. You can find more-detailed tutorials on using mental ray in *Using the mental ray Renderer (page 2–805)*.

- In the Render Output group, turn off Save File and turn on Rendered Frame Window.
- Scroll down to the Assign Renderer rollout and click the rollout title bar to expand it.
- Click the top Choose Renderer button, to the right of Production.

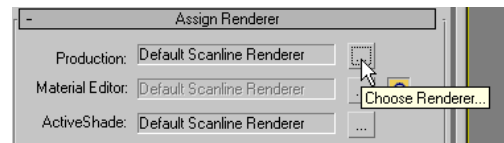

The Choose Renderer dialog appears.

- In the list, click the mental ray Renderer entry to highlight it, and then click OK.

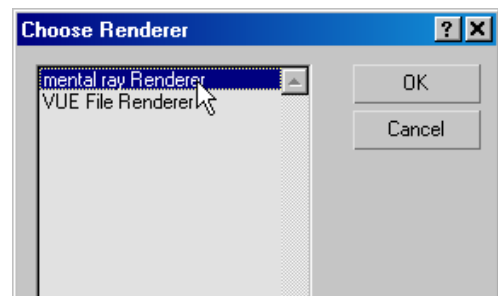

”mental ray” appears as the production renderer.

- Render the Perspective viewport.

The software renders the image to the rendered frame window. During the rendering process, you can see the small rectangles, or “buckets,” into which mental ray subdivides the image, appear one by one.

In the final image, the red and green apples and the ground plane all appear, because mental ray supports the same options as the default scanline renderer.

Other renderers are available as plug-ins; after installation, they appear on the Choose Renderer dialog.

6. Restore Default Scanline Renderer as the production renderer.

Rendering an Animation

There are some specific techniques to learn for rendering your animation into a movie file. You can render directly to a movie format such as AVI, or you can render a sequence of still image files to file formats such as TGA and then use the RAM Player to save them as a movie. The latter method is recommended. It requires a few more steps than rendering directly to a movie format, however it gives you more control over the file size and quality of the output. In addition, if you have frames that have artifacts or other errors, you can repair or remove them.

The next lesson will take some time to render. Depending on the speed of your computer, rendering may take a few minutes to several hours.

Set up the lesson:

- From the `|tutorials|walkthrough` folder, open `great_wall_render.max`.

Tip: If the Units Mismatch dialog displays, choose Adopt The File’s Unit Scale and then click OK.

This file is similar to the Animation Walkthrough tutorial. A bobbing motion has been added to the camera to simulate the up-and-down effect of someone jogging along the path. Two omni lights have been added to create additional lighting but there are no settings for Global Illumination in order to decrease rendering time.

Rendering an image sequence:

1. If the Camera viewport isn’t active, right-click in it to activate it.
2. From the Rendering menu, choose Render.
Next, you’ll define the animation range and output size.
3. On the Common tab of the Render Scene dialog, in the Time Output group, choose Active Time Segment.

This option automatically renders all currently playable frames. In this case, it should display 0 to 3000. Alternately, you could choose Range or Frames and set the frame range to render.

4. In the Output Size group, change the output resolution to 320x240.
5. In the Render Output group, click the Files button.

The Render Output File dialog opens.

6. Navigate to a directory where there is enough disk space to save the rendered files. You can use the Create New Folder button to establish a new location, if necessary.

Next you’ll define the type of still image file to render.

7. In the Save As Type field, click the drop-down arrow and choose JPEG File (*.jpg).

Note: In a production environment, you may want to use a high-quality, lossless format such as TGA or TIF. However, for the purposes of

this tutorial, you will use the JPG format to keep the size of the output files small.

8. In the File name field, type **my_jog.jpg**, then click Save.

After you click Save, a format-specific dialog asks you to specify attribute and information settings. Accept the default values, and then click OK.

When you render a still-image sequence, as in this case, the software automatically appends the first part of the file name with a four-digit frame number. So, the first frame will be *my_jog0000.jpg*, the second is named *my_jog0001.jpg*, and so on.

9. Make sure Save File is turned on in the Render Output group. Also check that the Viewport field at the bottom of the Render Scene dialog is set to TargetCam (not Top, Front, or Left), then click Render.

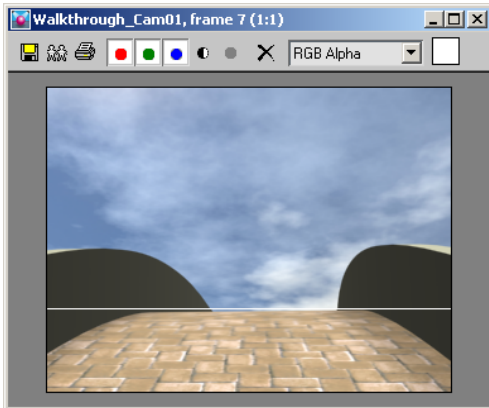

Note: A sky background is rendered. The dome representing the sky is an object that is hidden in the scene. However, the renderer is set to take hidden geometry into account.

10. The Rendering Progress dialog displays. Wait for a short while as the first frame is rendered. You will see the Last Frame Time, Elapsed Time, and Time Remaining values change after the first frame finishes.

Allow at least four frames to render.

At this point, you can work on something else while your animation is rendered.

Tip: You can also watch the rendering for errors or observe to see where you want to make changes. This is generally a good practice so that you can study the scene as it is rendered.

After the rendering has completed, you will have 3000 JPG files in the folder you specified.

Convert an image sequence into a movie:

The RAM Player loads still image sequences into memory and plays them so you can watch them as a movie. It actually lets you load two different sequences and then compare them visually, but you won't use that functionality here. You'll simply use the RAM Player to save the files into an AVI file.

1. From the Rendering menu, choose RAM Player.

2.  On the RAM Player toolbar, click Open Channel A.
3. In the Open File Channel A dialog, navigate to the sequence of JPG image files. Highlight the name of the first file in the sequence and then ensure the Sequence option is turned on. Click Open.

The RAM Player will now load the image files in sequential order starting with the first file you selected. The Image File List dialog appears. Here you can use the Every Nth and Multiplier fields if you need to speed up or slow down your animation. If your animation is too slow, change Every Nth to 2 or 3. If your animation is too fast, increase the Multiplier.

4. Click OK.

The RAM Player Configuration dialog appears. Here you can observe and adjust your memory usage. There are also tools here to resize your animation, specify a range of frames to use, and

split the alpha (transparency) information into a separate file.

Note: In order to use transparency, the image file specified has to be able to process an alpha channel. JPG files do not contain any transparency information the way TGA, TIF and PNG images often do.

5. Increase the Memory Usage to its maximum for your system, and then press OK.

The RAM Player loads the rendered files into memory. In the Loading dialog, observe how much memory is being used and remains available.

If it looks like you are about to run out memory, click Stop Loading. If you have a low-memory system, reduce the number of frames to load and try again.



6. On the RAM Player toolbar, click the Play button and watch the movie play.



7. On the RAM Player toolbar, click the Save Channel A button.

The Save File dialog appears.

8. Choose AVI as the file type, and name the animation **my_jog.avi**. Click Save.

The AVI File Compression Setup dialog appears. Here you can choose a codec (compression/decompression type) and adjust the quality of the file. Choose the default Cinepak Codec. To reduce file size, lower the quality to 75%.

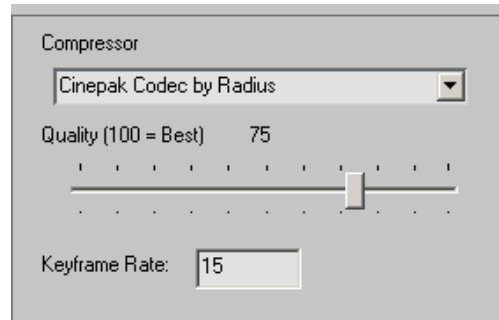

9. Click OK to continue.

Summary

You have learned how to render your animation to a sequence of still image files. This allows you better control for later correction of your animation. You also learned how to assemble a still image sequence into a movie file, such as AVI or QuickTime using the RAM Player.

Creating an Animated Shadow Study

In addition to animating a camera, you can animate the Daylight system's time of day. This is a good way to create a shadow study.

Set up the scene:

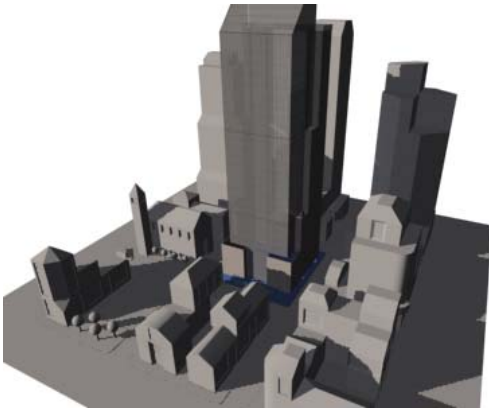

- From the `|tutorials|high_rise|` folder, open `cityscape.max`. If you encounter a File Unit Mismatch message, choose Adopt Unit Scale, the second choice.

This is a scene of nine city blocks, with a skyscraper at the center. The scene contains a Daylight system. The Daylight system is set to position the scene at the latitude of San Francisco, California, and the sun is set at 0700 hours, about the time of dawn on a winter day.



Tip: *Rendering a Daylight Scene* (page 1–448) takes you through the steps of creating a Daylight system.

Animate the daylight:

1.  Make sure Select Object is active on the toolbar.
2. In the Left viewport, click the sun object in the viewport to select it.
Daylight01 appears in the name field on the command panel.
3. Open the Motion panel.
4. On the Motion panel, scroll if necessary to the Control Parameters rollout.
5.  Turn on the Auto Key button.
 The button, the track bar, and the border of the active viewport all turn red.
6. Drag the time slider to frame 5, and then on the Control Parameters rollout, change the Hours value to 8.

The spinner arrows of the Hours, Minutes, and Seconds fields are now bracketed in red, indicating that you have set a key to animate the time of day.

7. Drag the time slider to frame 10, and then change Hours to 9.
8. Continue dragging the time slider in five-frame increments, then increasing the time of day by one hour at each increment. Stop when the time is 17 hours (5 P.M.). This should be at frame 50.
You have set 10 keyframes (and 3ds Max has automatically set one at frame 0, as well) to track the course of the sun through a day. Drag the time slider and watch the Left viewport. The sun moves smoothly: 3ds Max interpolates from one keyframe to the next so each frame is different, even if it doesn't have a key on it.

Set the animation range:

As the animation only lasts 51 frames (0 to 50), you don't need the full default range of 101 frames.

1.  Click Time Configuration.
The Time Configuration dialog is displayed.
(This button is at the extreme lower right of the 3ds Max window.)
2. In the Animation group, change the value of End Time to 50, and then click OK.
Now the range of frames is no greater than the length of the animation.

Save your work:

- Choose File > Save Copy As. In the file dialog, name the file **my_shadows.max**, and then click Save.

Important: Save Copy As does not open the copy. The active file is still *cityscape.max*.

Tip: Always save your scene file before you render.

Render the animation:

Rendering the animation takes about half an hour on a high-speed system. If you want, you can skip these steps and just view the file *shadow_study.avi*,

provided with the other tutorial files. See “View the animation,” below.

1. Choose Rendering > Render.

The Render Scene dialog is displayed, with the Render panel active.

2. On the Common Parameters rollout, in the Time Output group, choose Active Time Segment: 0 To 50.

In the Output Size group, make sure that the resolution is 640x480.

A smaller size would render more quickly, but the shadows don't show up as well.

3. On the Render Output rollout, click the Files button.

A Render Output File dialog is displayed.

4. Enter a name for the animation, and choose one of the animation formats from the Save As Type drop-down list, and then click Save.

You can render an animation to either the AVI or MOV (QuickTime®) formats. After you click Save, you see a format-specific dialog that asks you to specify the animation's compression. You can accept the default values, and then click OK.

Note: In practice, it's a good idea to avoid rendering directly to movie formats such as AVI or MOV. Instead render to sequentially numbered still image frames, and then convert them to a movie format as a second step. This has practical value if you need to correct mistakes in individual frames, without having to re-render the entire animation.

5. Open the Assign Renderer rollout and confirm that the Default Scanline Renderer is the production renderer. If you see mental ray renderer click Choose Renderer and change the renderer back to the Default Scanline Renderer.

Note: The mental ray renderer does not support the IES Sun lighting.

6. Leave the other Render Scene settings as they are, make sure *Camera02* is the active viewport, and then click Render.

3ds Max renders the animation. This takes a while (about a half hour on the high-speed system), so this is a good point to take a break.

View the animation:

1. When rendering is done, choose File > View Image File.

A View File dialog appears.

2. Choose the file you just rendered, and then click Open.

Tip: You can also choose *shadow_study.avi*, which is provided with the other tutorial files.

Depending on the movie type, a Media Player or a QuickTime viewer is displayed, which lets you play the animation.

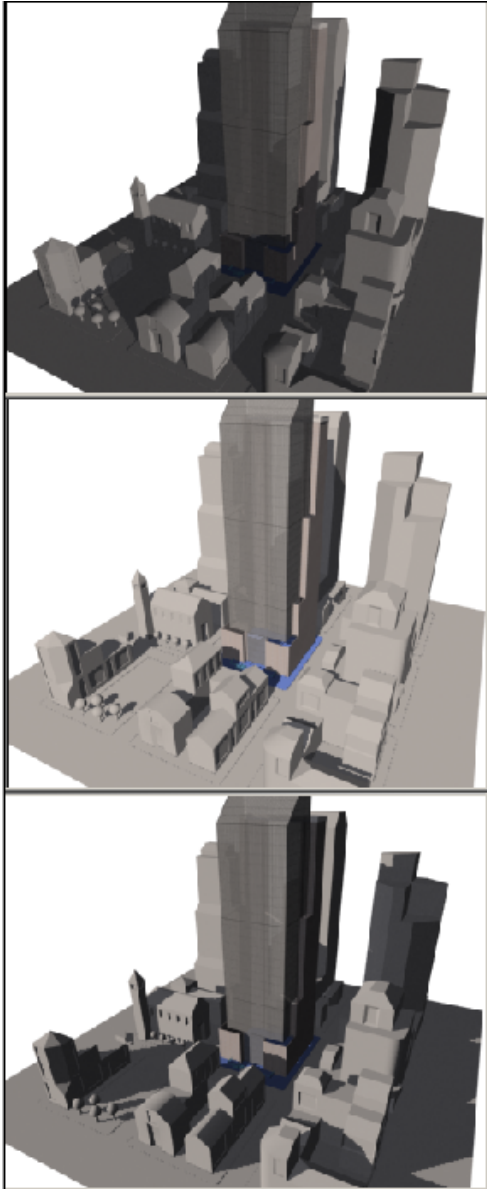

intervals of frames. (The longer the interval, the slower the animation will play.)

Advanced Lighting and Global Illumination

The lessons in this section demonstrate some of the advanced lighting features of 3ds Max. *Advanced lighting* is a blanket term for global illumination options. “Global” illumination is light that has been reflected off other objects. When you render using global illumination, the amount of ambient light in the scene increases, and colors of one object can “bleed” onto other objects. The two global illumination options available to the scanline renderer are *radiosity* and the *Light Tracer*. Radiosity is the more accurate of the two options, and it works in concert with exposure control.

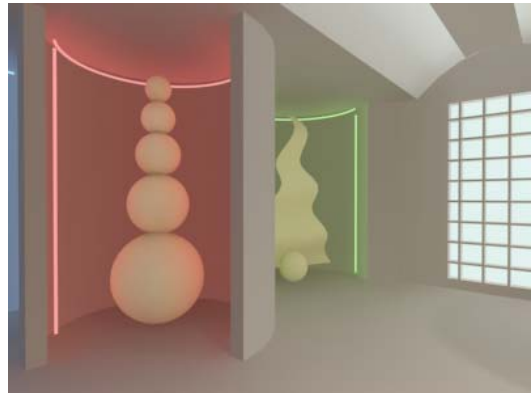

Radiosity combined with override material creates glowing colored light in a gallery scene.

Summary

You can create a shadow study by animating the time of day of a Daylight system. To do so, use the Auto Key button, and change the hour at regular

Note: The mental ray renderer has its own method of global illumination. For lessons on this renderer, see *Using the mental ray Renderer (page 2–805)*.

Skill Level: Intermediate

Time to complete: 45 minutes

Features and Techniques Covered in This Section

- Using photometric lights with radiosity to render an indoor scene.
- Using the Advanced Lighting Override material to increase the realism of self-illuminating materials.
- Using a Skylight and light tracing to render an outdoor scene.
- Using a Daylight system and radiosity to render an outdoor scene with control over time and global location, and physically accurate light levels.
- Using exposure control to handle the extreme brightness of outdoor daylight.

Creating a Radiosity Solution

In this lesson, you create a rendering, then create a radiosity solution and render it to view the difference in lighting levels. Finally, you polish the rendering a bit.

Set up the scene:

1. From the `\tutorials\adv_lighting\` directory, open `library_rendering_intro.max`.
3ds Max displays a single viewport, with an interior view of a design for a library building.
Note: All the necessary files to do the tutorials can be found on the Tutorial Files CD that ships with 3ds Max. Before doing the tutorials, copy the `tutorials` directory from the CD to your `13dsmax8` local installation.
2. A warning might appear, pointing out that the scene's units are different from the default 3ds Max units. Choose **Adopt The File's Unit Scale**, and then click **OK**.
3. The wireframe view is somewhat hard to read. Right-click the viewport label (in the upper-left

corner). Choose **Smooth + Highlights** from the pop-up menu.

Now the room is easier to read.

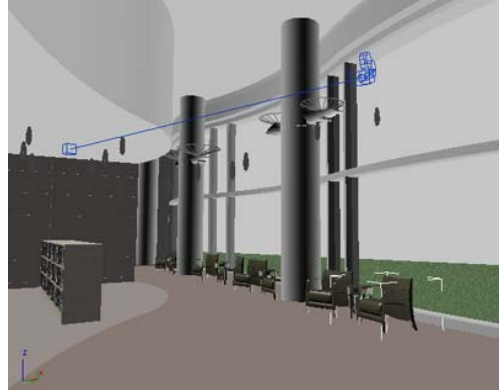

Render the model:

1.  On the main toolbar, click **Render Scene**.
A **Render Scene** dialog is displayed, with the **Common** panel visible.
2. On the **Common Parameters** rollout, in the **Output Size** group, make sure the output size is **320x240**.

Rendering can be a slow process, so use the small size at first. If you are happy with the image, you can render it at a higher resolution later.

3. Click **Render**.



The completed rendering is very dark. This is because it shows direct light, but not bounced light. Direct light is light cast by the lights in the scene, with no bouncing off of surfaces. In reality, light continues moving after it hits a surface (at least, most kinds of surfaces), and much ambient light is created by bounced light. Recessed lighting, as in the library model, depends on the effect of bounced, indirect light. In the procedures that follow, you will make 3ds Max generate the indirect light in the scene.

Clone the rendered frame:

First, make a “clone” of the rendered frame so you can compare the rendering you just made, with the next one.

-  On the toolbar of the rendered frame window, click Clone Rendered Frame Window. 3ds Max displays a cloned copy of the frame window. Cloning the window is often useful when you are doing a series of test renderings.

Generate a radiosity solution:

To model the effect of bounced light in the scene, you generate a radiosity solution. Radiosity models the effect of diffuse light bouncing among surfaces.

1. On the Render Scene dialog, click the Advanced Lighting tab.
The Advanced Lighting panel is displayed.
2. On the Select Advanced Lighting rollout, choose Radiosity from the drop-down list.
Various rollouts for radiosity are now displayed on this panel.
3. Open the Radiosity Meshing Parameters rollout, and turn on Enabled under Global Subdivision Settings.
4. Turn the Use Adaptive Subdivision option off. This simply ensures that all objects are treated in the same way when the solution is

generated. When on, this option allows for finer subdivision only in areas where it is needed.

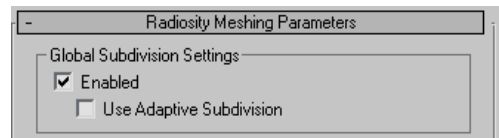

5. In the Radiosity Processing Parameters rollout, under the Interactive Tools group, set both the Direct and Indirect Light Filtering options to 2. This will smooth off any noise patterns generated by the radiosity solution.

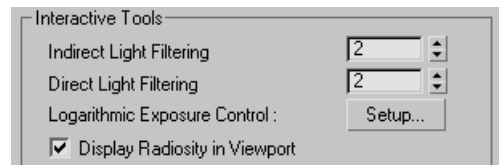

6. Open the Rendering Parameters rollout, and choose Re-Use Direct Illumination From Radiosity Solution.

This option will speed up rendering.

7. On the Radiosity Processing Parameters rollout, set Initial Quality to 60 per cent.
This helps limit the time to generate the solution.

8. Also on the Radiosity Processing Parameters rollout, click Start.

As the progress bar shows, 3ds Max processes radiosity in several passes, each with a higher percentage of the total. Generating the radiosity solution usually takes several minutes. You might want to take a coffee break while 3ds Max calculates. When the calculation of the radiosity solution is done, the Stop button will be disabled, but Reset All, Reset, and Start will be enabled.



Stop button is available while the generation of a radiosity solution is in progress.



After the radiosity solution has been generated, the Reset All and Reset buttons become available.

9. Click Render.

You can click the button at the bottom of the dialog without going back to the Common panel.

The new rendering appears quickly, and the room is now filled with indirect light.



If you change the viewport display mode back to wireframe, you see a busier scene than you saw before.

The radiosity solution adds geometry to your scene. The additional mesh you see in the wireframe view is known as the *radiosity mesh*. Light levels are stored in this mesh. Generating a radiosity solution adds complexity to your scene and increases the size of your MAX file. Offsetting these costs, the radiosity gives you some advantages:

- If you turn on Re-Use Direct Illumination From Radiosity Solution, as you did in this exercise, the renderer gets its lighting information from the radiosity mesh, so rendering proceeds very quickly.
- The radiosity mesh is three-dimensional. You can move the camera, or change the view, and rendering with Use Radiosity turned on will show the radiosity from a different point of view.

In fact, if the only animation in your scene is a moving camera, then you only need to calculate radiosity once, at the first frame. (You *do* need to recalculate radiosity for other frames if the animation includes moving objects that cast shadows.)

Note: Unlike radiosity, reflections and refractions depend on your point of view. (If you look at a mirror from different angles, you see different reflections in it.) When you render a scene with reflective or refractive materials, 3ds Max generates the reflections and refractions using ray-tracing, which complements the radiosity solution.

Use antialiasing to improve the rendering's appearance:

You might have noticed some jaggedness in the rendered scene, particularly along the window frame halfway up the exterior wall. This is easy to fix.

1. On the Render Scene dialog, click the Renderer tab to go to the Renderer panel.
2. On the Renderer panel's Default Scanline Renderer rollout, click to turn on Antialiasing in the Antialiasing group.
3. Click Render again.

The scene renders a bit more slowly, but it appears smoother.



In general, when you render there is always a trade-off between speed and quality. The lesson *Speeding Up Rendering* (page 1-441) explains some other ways to manage rendering speed.

Save your work:

- Choose File > Save As. In the file dialog, name the file **my_library.max**, and then click Save.

Summary

To sum up what this lesson has covered:

- To model the indirect lighting in a scene, generate a radiosity solution.
The radiosity controls are on the Advanced Lighting panel of the Render Scene dialog.
The radiosity solution stores lighting levels in a 3D radiosity mesh, which you can render from different points of view.
- The Antialiasing toggle on the Renderer panel > Default Scanline Renderer rollout > Antialiasing group gives a smoother rendering at a cost of some rendering time.

In general, rendering involves a trade-off between speed and quality.

Speeding Up Rendering

There are a number of ways to get a quicker rendering for draft purposes. This lesson shows you a few. In general, these are the methods you can use:

- Use a small image size, such as 320 x 240, for draft renderings.
- Turn off antialiasing and mapping.
(Turning off shadows also helps if you are not reusing direct illumination from the radiosity solution.)
- Turn off layers with inessential objects.
- Use one of the “Draft” rendering presets.

Set up the scene by doing one of the following:

- Open *my_library.max*, which you created in the previous lesson.
- From the `|tutorials|adv_lighting|` directory, open *library_with_radiosity.max*.

If you see the [File Load: Units Mismatch dialog](#), choose the option Adopt The File’s Unit Scale. This will change your system unit, so be sure to [reset your system unit after completing this tutorial](#).

To reset your system unit, go to the Customize menu and choose Units Setup > System Unit Setup > System Unit Scale > Inches.

Note: All the necessary files to do the tutorials can be found on the Tutorial Files CD that ships with 3ds Max. Before doing the tutorials, copy the `|tutorials|` directory from the CD to your `|3dsmax8|` local installation.

Turn off antialiasing and maps:

1. Choose Rendering > Render.
The Render Scene dialog is displayed.
2. Go to the Renderer panel. On the Default Scanline Renderer rollout, in the Antialiasing

group, turn off Antialiasing. In the Options group, turn off Mapping as well.

3. Click Render.

The rendering goes quickly, but edges are jaggy, and the rendering doesn't show details provided by texture maps.



Note: The radiosity in this scene was created with the option Re-Use Direct Illumination From Radiosity Solution. Because of this, the shadows in the scene come from the radiosity mesh. (Sometimes shadows from the mesh can be grainy and inaccurate.) If you had generated radiosity with the option Render Direct Illumination instead, then turning off Shadows in the Options group would also help speed up render time.

Using a layer to hide objects:

Hiding more complicated objects, especially if they aren't essential to an overall visualization, is another way to speed up rendering time.

1. On the Layers toolbar, click the downward-pointing arrow at the left of the Layer List to display the list.

(If the Layers toolbar is not visible, right-click a blank area of another toolbar, and choose Layers from the pop-up menu.)

2.  Click to turn off the Visible icon of the Furniture layer.

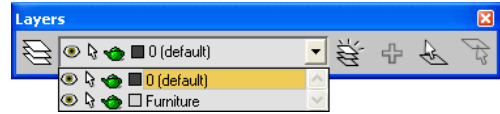

The eyeball icon indicates whether a layer is on or off.

The bookcase, chairs, and end tables are now hidden in the scene.

3.  Click Quick Render.

The scene renders without the geometry of chairs, tables, and bookcase.



Note: The shadows of the furniture, especially the bookcase, are still there. This is a by-product of reusing direct illumination from the radiosity mesh.

Use the "Draft" presets:

The Render Scene dialog provides preset parameters for different levels of rendering.

1. Turn the Furniture layer back on.
2. At the bottom of the Render Scene dialog, choose Load Preset from the Preset drop-down list. A file dialog is displayed. Choose the preset named *3dsmax.scanline.radiosity.draft.rps*, and then click Open.

A Select Preset Categories dialog is displayed.

3. On the Select Preset Categories dialog, CTRL+click to remove the highlight from Environment and Raytracer. Make sure Default Scanline Renderer and Advanced Lighting are highlighted, then click Load.

An alert warns you that this preset will recalculate the radiosity solution. Click Yes.

4. Go to the Advanced Lighting rollout, and click Start to recalculate radiosity using the preset values.

This doesn't take long, because the draft preset specifies an Initial Quality of only 10.0 percent.

5. Click Render.

This time there is a bit of a delay. The draft preset for radiosity has Render Direct Illumination chosen. Even so, it doesn't take too long to get an overall idea of how a polished version of the rendering might look.

If you want to experiment with the other rendering presets, go ahead. Options on the presets drop-down list also let you create your own presets.

Save your work:

- Choose File > Save As. In the file dialog, name the file **my_radiosity_renderings.max**, and then click Save.

Summary

To sum up what this lesson has covered, when you need a draft or a preview of a rendering, you can speed up the rendering process in a number of ways:

- Using a small image size, such as 320 x 240.
- Turning off antialiasing and mapping, and turning off shadows if you are not reusing direct illumination from the radiosity solution.
- Turning off layers with inessential objects.
- Using one of the "Draft" rendering presets.

Adjusting the Quality of Radiosity

As the previous lesson described how to obtain renderings more quickly, this lesson describes how to obtain a radiosity solution more quickly. It also describes how to obtain more polished renderings that use radiosity.

Quicker Solutions

There are two strategies for speeding up the generation of a radiosity solution:

- Lowering the percentage of Initial Quality.
Radiosity is generated in multiple passes. The lower the quality, the quicker the solution is generated.
- Excluding objects from the radiosity calculations.

Large surfaces in a scene contribute most to the bouncing of light. Smaller, fussier objects, on the other hand, contribute less bounced light but take a long time to calculate, because of their complexity.

Setting a lower value, such as 30 or 40 per cent, for Initial Quality is straightforward, so we won't walk you through that step.

Set up the scene by doing one of the following:

- Open *my_radiosity_renderings.max*, which you created in the previous lesson.
- From the `|tutorials|adv_lighting|` directory, open *library_with_radiosity.max* once again.

If you see the [File Load: Units Mismatch dialog](#), choose the option Adopt The File's Unit Scale. This will change your system unit, so be sure to [reset your system unit after completing this tutorial](#).

To reset your system unit, go to the Customize menu and choose Units Setup > System Unit Setup > System Unit Scale > Inches.

Note: All the necessary files to do the tutorials can be found on the Tutorial Files CD that ships with 3ds Max. Before doing the tutorials, copy the *tutorials* directory from the CD to your *3dsmax8* local installation.

Choose the objects to exclude:

In this model, the walls, windows, floor, columns, and ceiling contribute the most bounced light. The “fussier” geometry such as furniture and lighting sconces are the objects that take calculation time without adding a lot of indirect light to the solution.

1.  Click Select By Name.

The Select Objects dialog is displayed.

2. In the list of objects, use CTRL+click to highlight *[books]*, *[chair]* through *[chair12]*, *[sconce1]* through *[sconce3]*, and *[table]* through *[table03]*.
3. Click Select.

The objects are highlighted in the viewport.

Exclude the objects from radiosity calculations:

1. In a viewport, right-click one of the selected objects.
Tip: The foremost chair is an easy one to use.
The quad menu is displayed.
2. On the Transform (lower-right) quadrant of the quad menu, choose Properties.
The Object Properties dialog is displayed.
3. Go to the Advanced Lighting panel. In the Radiosity-Only Properties group, click to turn off Diffuse.
4. Turn off Exclude From Regathering as well, and then click OK.

The bookcase, chairs, lighting sconces, and tables are now excluded from radiosity calculation.

See the effect of excluding geometry from radiosity calculations:

1. Choose Rendering > Advanced Lighting > Radiosity.
The Render Scene dialog is displayed, with the Advanced Lighting panel active and the radiosity rollouts visible.
2. Make sure Initial Quality is still set to **10** per cent or less.
3. Open the Rendering Parameters rollout, and choose Re-Use Direct Illumination From Radiosity Solution.
4. On the Radiosity Processing Parameters rollout, click Reset All, and answer Yes to the warning.
5. Click Start.

Processing radiosity still takes some time, but it goes more quickly than it would if the excluded geometry were part of the calculations.

If you render the scene, you see that the result is little different from the radiosity solution you obtained in previous lessons.



The differences are subtle. Unless they are directly lit, surfaces near the furniture and sconces are a little dimmer than they appear when the entire scene contributes to the radiosity solution, but the

rendering is an acceptable draft, and it took a few minutes less to generate the solution.

Better Solutions

Eventually, you will want to create a polished rendering that uses radiosity. In this case, you should use the Rendering Parameters rollout to choose Render Direct Illumination. The radiosity solution still provides indirect light, but the effect of direct light is calculated at render time. So are shadows, which become more fine-grained and accurate as a result.

Set up the scene:

- From the `|tutorials|adv_lighting|` directory, open the file `library_direct_render.max`.

This is the same scene you have been using, but to save time it contains a radiosity solution generated with the Render Direct Illumination option. The radiosity mesh stores the scene's indirect illumination. When you render, the renderer will generate direct illumination and shadows “on the fly.”

Render the scene and its shadows and direct lighting:

1. Choose Rendering > Render.

The Render Scene dialog is displayed.

2. Click Render.

The scene renders more slowly than when the Re-Use Direct Illumination option was active. However, it shows more accurate and more subtle lighting.



In particular, the “scallops” from recessed lighting on the wall on the left did not appear in previous renderings. As with shadows, sometimes the radiosity mesh is not fine enough to capture details accurately.

Save your work:

- Choose File > Save As. In the file dialog, name the file **my_finished_library.max**, and then click Save.

Regathering

The final, optional step of generating a radiosity solution is known as *regathering*. Regathering is an additional check for, and elimination of, unrealistic artifacts of the radiosity and rendering calculations. It is especially useful for eliminating the “leaks” of light and shadows that can occur when the geometry of, for example, a floor and a wall, is not accurately and tightly joined in the model.

The Regather Indirect Illumination option is on the Rendering Parameters rollout of the Advanced Lighting panel. It is available only when the active option is Render Direct Illumination. There are a number of options that control how regathering is calculated. These are described in the *User Reference*.

Regathering can *greatly* increase rendering time. Because of this, and because regathering doesn't significantly improve the rendering of the library model, we won't walk you through the steps.

Summary

You can generate a “rough” radiosity solution to get a preview of a rendered scene, or a polished, physically accurate solution and rendering.

- To get a quick and rough radiosity solution, lower the Initial Quality percentage.
- To get a less accurate but quicker solution, you can also select geometry that won't contribute much bounced light, and set this geometry's Rendering Properties to not contribute diffuse light.
- To get a more polished and accurate rendering, increase the Initial Quality percentage. On the Rendering Properties rollout, choose Render Direct Illumination as the active option.

Also, on the Renderer panel > Default Scanline Renderer rollout, make sure that Antialiasing, Mapping, and Shadows are all turned on.

Changing How Objects Behave Under Global Illumination

The global illumination options, radiosity and light tracing, use object colors when they calculate the color and energy of bounced light. Sometimes you want to change how an object behaves in the globally illuminated scene. In this example, you set up some objects to emit light that affects radiosity. The way to adjust a material's behavior under global illumination is to give it an Advanced Lighting Override material.

Set up the scene:

1. Navigate to `tutorials\adv_lighting\` and open `gallery_no_override.max`.

Note: All the necessary files to do the tutorials can be found on the Tutorial Files CD that ships with 3ds Max. Before doing the tutorials, copy the `tutorials` directory from the CD to your `3dsmax8` local installation.

2. If the File Load: Units Mismatch dialog is displayed, select Adopt the File's Unit Scale, and click OK to continue.

The scene shows another part of the gallery, with two sculpture installations surrounded by neon lights. These neon lights are modeled simply as cylinders with self-illuminating materials.

Render the scene:



- Make sure the Camera02 viewport is active, then on the toolbar, click Quick Render.

The rendered scene shows the neon lights with glowing colors, but their glow has no effect on the scene around them. An object's self-illumination color has a glowing look to it, but doesn't actually emit light in the scene.

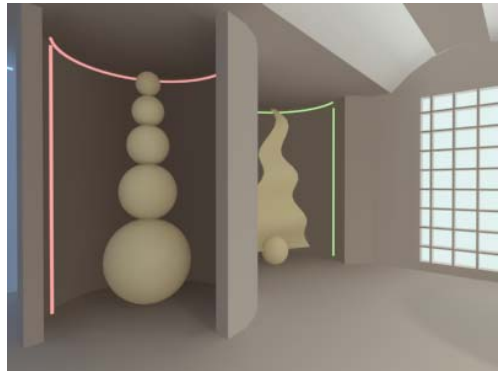

Scene with self-illuminating neon but no true light emission

Get the materials from the neon lights:



1. Open the Material Editor. Scroll to a couple of unused sample slots. (Unused sample

slots show a plain gray sphere, and have no angle brackets in the corners.)

-  Activate one sample slot. Turn on Pick Material From Object (the eyedropper button), then click one of the cylinders that surround the stack of spheres on the left. These neon light objects are *Cylinder02*, *Cylinder03*, and *Cylinder04*.

The material Neon Red No Override is loaded into the sample slot.

-  Activate another empty sample slot and do the same for one of the cylinders surrounding the wavy triangle. These neon light objects are *Cylinder05*, *Cylinder06*, and *Cylinder07*.

The material Neon Green No Override is loaded into the other sample slot.

Turn the materials into Advanced Lighting Override Materials:

- Click the Neon Red No Override sample slot to activate it. Then click the Material Type Button (which now says Standard).

The Material/Map Browser appears.

- In the Material/Map Browser, highlight Advanced Lighting Override, and then click OK. In the Replace Material dialog that is displayed, make sure to choose Keep Old Material As Sub-Material, and then click OK.

Now the red self-illuminating material is contained within the Override material.

- On the Advanced Lighting Override Material rollout, in the Special Effects group, change Luminance Scale from 0.0 to **1000.0**.

Now the material will emit light in the scene.

You might notice that the controls in the Override Material Physical Properties group are for adjusting how much light the material reflects and transmits.

- Repeat steps 1 to 3 for the Neon Green No Override material.

Recalculate the radiosity solution:

Because you got the materials directly from the objects, they are “hot” materials and you don’t need to reapply them in the scene. However, if you render the scene again now, you will see no change. This is because you need to recalculate the radiosity solution as well.

- Choose Rendering menu > Advanced Lighting > Radiosity.

The Render Scene dialog appears, opened to the Advanced Lighting panel.

- On the Radiosity Processing Parameters rollout, click Reset All, and click Yes in the warning dialog.

- Click Start.

The radiosity solution is recalculated. This is a good time for you to take a break: the recalculation can take several minutes. The progress bar below the Start button shows the progress of each pass, and the quality percentage each pass achieves.

Render the scene:

-  Make sure the Camera02 viewport is active, then click Quick Render again.

The effect is subtle, but the neon now glows, tinting the alcoves and the sculptures that stand in them.

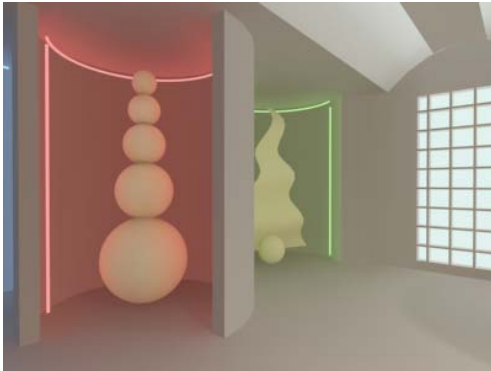

When neon objects emit light energy, they contribute colored light to the scene.

Save your work:

- Save the file as **my_neon_gallery.max**.

Rendering a Daylight Scene

In this lesson, you add daylight to a scene, and render it using radiosity in conjunction with exposure control.

Set up the scene:

- From the `|tutorials|adv_lighting|` directory, open `library_daylight.max`.

If you see the [File Load: Units Mismatch dialog](#), choose the option Adopt The File's Unit Scale. This will change your system unit, so be sure to [reset your system unit after completing this tutorial](#). To reset your system unit, go to the Customize menu and choose Units Setup > System Unit Setup > System Unit Scale > Inches.

This model is the interior of a library you used in earlier lessons.

Note: All the necessary files to do the tutorials can be found on the Tutorial Files CD that ships with 3ds Max. Before doing the tutorials, copy the `|tutorials|` directory from the CD to your `|3dsmax8|` local installation.

Look at the default view of the library:

-  Activate the Camera viewport, and then click Quick Render.

The default lighting of the library appears rather flat.

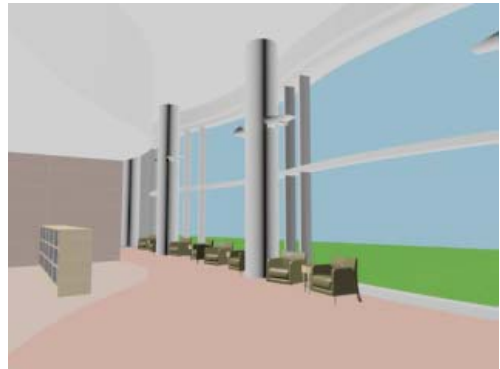

Note: If a dialog appears displaying Raytrace messages, you can disable it in the Render dialog by going to the Raytrace tab and turning Show Messages off.

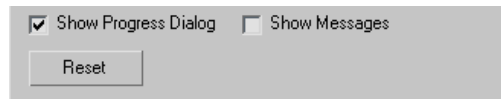

Add daylight to the scene:



You will use a Daylight system to model the sun. The Daylight system includes several components:

- A compass object to orient the scene.
- A sun light to model the sun itself.
- A sky light to model scattered light in the atmosphere.

You can set the sky to be Clear, Partly Cloudy, or Cloudy.

- Motion control that sets the geographic location and the time of day.

(There is no point in rendering a view when the sun is below the horizon!)

1.   Go to the Create panel, and click Systems to turn it on. On the Object Type rollout, click Daylight to turn it on.
2. In the Top viewport, drag to position the compass rose. Release the mouse, drag and then click to set the height of the sun object. Right-click to end the creation process.

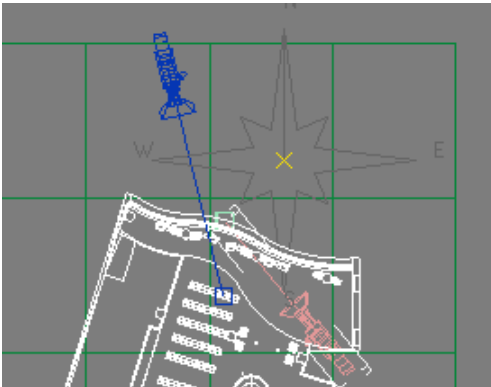

Drag in the top viewport to create the compass rose.

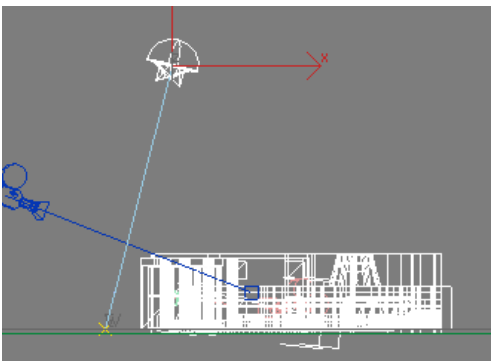

You can see the sun's height in the Left viewport. It doesn't really matter how high you position the sun object, as long as it is above the ground plane. The sun's position affects the scene, but sunlight is treated as parallel rays, as if they came from an extreme distance.



You can see the sun's elevation in the left viewport.

The orientation of the compass rose *does* affect the scene.

Orient the daylight system:

1.  Turn on Select Object.
2.  In the top viewport, click to select the Daylight01 object if it is not already selected, and then go to the Motion panel.
3. Change the North Direction angle to **140** degrees.

Ensure the daylight system is photometric:

1. Make sure the Daylight System (Daylight01) is still selected
2.  In the Modify panel, set the Sunlight and Skylight types to IES Sun and IES Sky respectively if this is not done already.

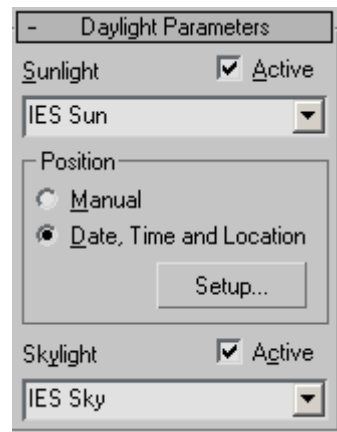

Note: The IES Sun and IES Sky are the photometric versions of sunlight and skylight.

Change the time of day:

-  Go the Motion panel. On the Control Parameters rollout, in the Time group, change the value of Hours to **15**.

The Daylight system uses a 24-hour clock, from 0 (midnight) to 23 (11 P.M.). So 15 Hours corresponds to 3 P.M.

With this orientation and time of day, the view of the library in the camera view will show fairly good lighting effects.

Look at the result:

- Click Quick Render.

The image of the library in sunlight appears washed out. This is because of the considerable intensity of the photometric sunlight that is part of the Daylight System. Photometric lights provides physically based simulation of the propagation of light through an environment, but you need to use Exposure Control to compensate for that intense energy.

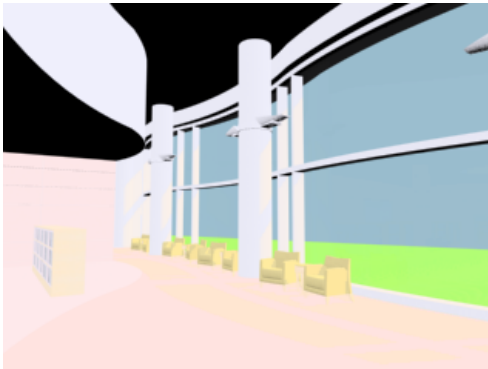

Adjust the exposure control:

Exposure control adjusts the brightness and contrast of the scene, along with some other settings. You can think of it as working like the controls on a camera. The main reason for controlling exposure is that monitors have a range of about two orders of magnitude: the brightest color on a display is about 100 times brighter than the dimmest. By comparison, the eye can perceive a range of about 16 orders of magnitude: the brightest color we can see is about 10^{16} times brighter than the dimmest.

Another reason for exposure control is simply to adjust the appearance of a rendering to make it easier to read or more appealing.

1. On the Rendering menu, choose Environment.

The Environment And Effects dialog is displayed. Exposure controls are on the Environment panel > Exposure Control rollout. An additional rollout contains the controls specific to the type of exposure control you choose.

Notice that on the Exposure Control rollout, Logarithmic Exposure Control is chosen, and the Active toggle is turned on. 3ds Max did this silently when you added a Daylight system to your scene. Daylight almost always requires an exposure control, as you will see in the following steps.

2. Right-click the camera viewport to make sure it is active.
3. On the Exposure Control rollout, click Render Preview.

After a pause, the thumbnail image shows a preview of the rendered scene.

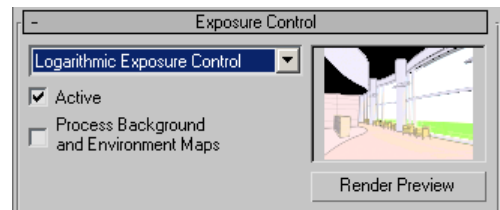

As you might expect, levels in the thumbnail are like those in the rendered frame.

4. Click to turn off the Active toggle.

More of the thumbnail image is burned to white. Now you cannot see the furniture or the outside terrain anymore.

One advantage of the thumbnail on this rollout is that it is interactive. Once you have rendered

it, changing the exposure control changes the preview without requiring you to render again.

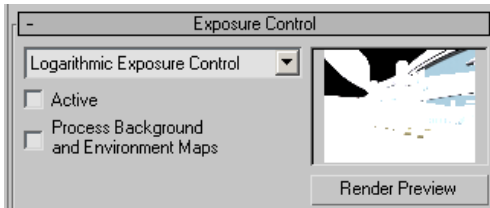

Rendering with radiosity uses correct physical scale. Without exposure control, the extreme intensity of sunlight burns out exterior scenes.

5. From the drop-down list, notice that you have different exposure types to choose from. Arguably, Logarithmic Exposure is the best choice as it does a better job at compressing a huge range of brightness levels into the limited range of a monitor. This is why it is recommended for the Daylight System.
6. Leave the Exposure type to Logarithmic and turn on the Active option again. In the Logarithmic Exposure Controls Parameters rollout, click to turn on Exterior Daylight.

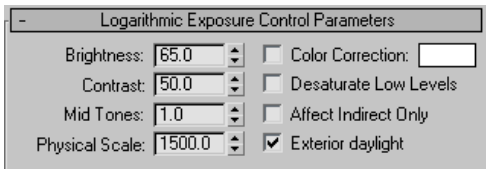

The thumbnail now shows much better levels of brightness and contrast. The Exterior Daylight toggle compensates for direct sunlight.

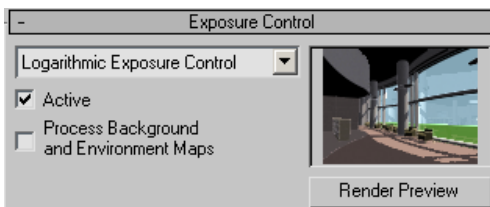

Generate a radiosity solution:



1. Click Render Scene to display the Render Scene dialog.
2. Go to the Advanced Lighting panel. On the Select Advanced Lighting rollout, choose Radiosity from the drop-down list.

Various rollouts for radiosity are now displayed on this panel.

3. Open the Radiosity Meshing Parameters rollout, and turn on Enabled under Global Subdivision Settings.
4. Turn off Use Adaptive Subdivision. This option subdivides the geometry in a finer grid only where needed, but you will not use it in this lesson.

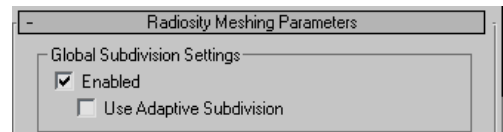

5. On the Radiosity Processing Parameters rollout, set Initial Quality to **50.0** per cent.

You don't need a high-quality solution to see the general effect in this scene.

6. In the Interactive Tools group, set both the Direct and Indirect Light Filtering to **2..** This will smooth out some of the noise patterns resulting from the radiosity calculation.

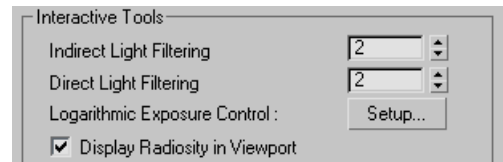

7. On the Radiosity Processing Parameters rollout, click Start.

Wait till the radiosity solution is created. (The Stop button becomes unavailable, and the Reset buttons become available.)

8. Click Render.



Reflected light illuminates the ceilings, and other areas that were much darker prior to the radiosity calculation.

Adjust the logarithmic exposure control:

When you use Logarithmic Exposure with the Daylight System, the Exterior Daylight setting sometimes overcompensates and leaves the scene somewhat darker than anticipated. This is easy to fix.

1. On the Logarithmic Exposure Control Parameters rollout, change the Brightness value to **80.0**.

The thumbnail updates accordingly.

As you know if you have worked with image-editing applications, increasing brightness can wash out an image, so bump up the contrast as well.

2. Change the Contrast value to **60.0**.

The change in the thumbnail is slight, but the effect will be apparent in the rendering.

3. Click Render once again.

The library is now convincingly lit, and shows details that weren't apparent before.



Save your work:

- Choose File > Save As. In the file dialog, name the file **my_sunlight.max**, and then click Save.

Summary

To simulate natural sunlight, you can use a Daylight system. Daylight lets you set the geographic location of a site, the site's orientation (north, south, east, and west), and the time of day. It also lets you set whether the sky is clear or cloudy.

Use the Logarithmic exposure control for most purposes, as this type does a better job at compressing a huge range of brightness levels into the limited range of a monitor. Turn on the Logarithmic exposure control's Exterior Daylight toggle when using a Daylight object or a light type with a very strong intensity. If this setting overcompensates for the sun, you can adjust the Brightness and Contrast to correct this.

Using Radiosity with Standard Lights

For their accurate realism and their ease of use with radiosity solutions, we encourage you to use photometric lights when you create new models. However, if you use older models, or if you want to create a quick lighting study that doesn't rely on

physical realism, you might find yourself working with standard lights. There are some differences in the use of the two kinds of lights. The most important of these are described in this lesson.

Standard Light Intensity

Instead of the physical intensity that you specify for photometric lights in candelas, lumens, or lux, standard lights have a Multiplier value. At 1.0 (the default), the light is at its full intensity. Lower Multiplier values express a normalized percentage of the full intensity. You can also increase the multiplier to be greater than 1.0, but this is not recommended because large Multiplier values tend to create “burned out” areas that don’t look realistic and often don’t transfer well to video.

Standard Lights and Radiosity

Whether you use photometric or standard lights for an indoor scene, direct illumination alone usually results in a dim rendering. You need to generate a radiosity solution to get a fully lit scene. Standard lights can generate radiosity. The exposure controls provide an additional setting, Physical Scale, to compensate for the inaccuracy of standard lights, as shown in the demonstration that follows.

Set up the scene:

- From the `|tutorials|adv_lighting|` directory, open `interior_unfinished_std_lights.max`.

Note: All the necessary files to do the tutorials can be found on the Tutorial Files CD that ships with 3ds Max 8. Before doing the tutorials, copy the `|tutorials|` directory from the CD to your `|3dsmax8|` local installation.

This model is the interior of a house, with no furniture added.

View the lighting of the scene:

The lighting consists of standard lights: two unique omni lights in opposite corners of the room, and a row of four spotlight instances down the center of the room.

- Choose Tools > Light Lister.

The Light Lister is displayed.

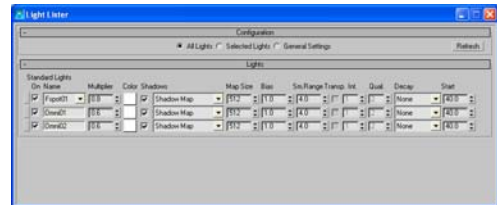

Only one spotlight, *Fspot01*, appears on the light lister, because the other three spots are instances of it. As you can see from the Multiplier fields, the lights are not at full intensity.

Note: More information about the light lister is provided in the lesson *Managing Multiple Lights (page 1-419)*, which follows.

Render the scene:



- On the main toolbar, click Quick Render.

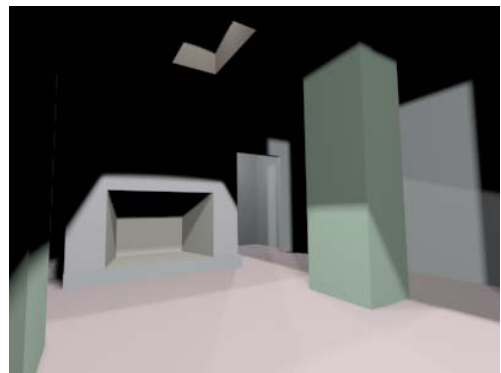

As usual when only direct light is rendered, a lot of the scene remains in shadow.

Generate a radiosity solution:

1. Choose Rendering > Advanced Lighting > Radiosity.

The Advanced Lighting panel of the Render Scene dialog is displayed.

2. Open the Rendering Parameters rollout, and make sure that Render Direct Illumination is chosen.

Warning: If Re-Use Direct Illumination is chosen, and direct illumination is “baked in” to the radiosity solution, then adjusting exposure control will have no effect on renderings. And as you will see in the steps that follow, you need to adjust the exposure control when you work with standard lights.

3. On the Radiosity Processing Parameters rollout, click Start.

Although the Initial Quality is set to 85 percent, this is a fairly simple model, so the solution is generated quickly.

4. Click Quick Render.

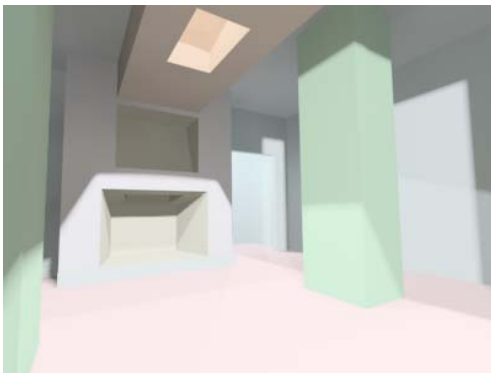

In the case of this scene, the initial solution is rather too bright. You will adjust that in the next procedure.

Use exposure to adjust the physical scale:

1. Choose Rendering > Advanced Lighting > Exposure control.

The Environment panel of the Environment And Effects dialog is displayed. The Logarithmic exposure control is active.

2. On the Exposure Control rollout, click Render Preview.

3ds Max renders a thumbnail of the scene.



The colors in the thumbnail look more realistic than the rendering. In this case, it appears that the Physical Scale is too great.

3. On the Logarithmic Exposure Control Parameters rollout, change the value of Physical Scale to **500.0**.

The preview thumbnail automatically updates to show the change.

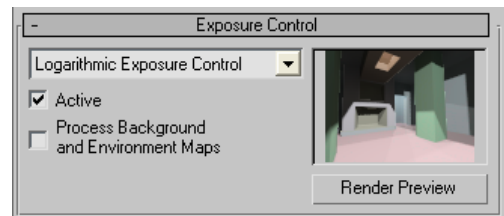

4. Click Quick Render.

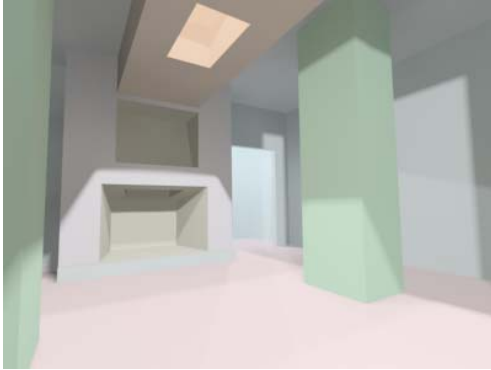

Now the rendering, especially the floor, doesn't look quite as washed out, but areas lit by reflected light still have detail.

If you like, experiment with other Physical Scale values. The differences can be subtle, and the preview tends to show more dramatic changes than the actual rendering. You might also experiment with the Linear exposure control. Linear exposure is sometimes useful for indoor scenes, but it doesn't work well with this one because of the large contrast between directly lit areas and the areas in shadow.

Summary

The Physical Scale value is multiplied by each standard light's Multiplier value to obtain a value in candelas that the exposure control can use. Adjusting the Physical Scale adjusts the lighting level of the scene to obtain a useful rendering. The default Physical Scale value of 1500 turns a standard omni light with a Multiplier of 1.0 into an isotropic photometric light of 1500 candelas. However, when you work with standard lights, you should remember that the solutions and renderings you obtain are always approximate.

Rendering a Panorama

In addition to rendering image files and animations, you can render a three-dimensional panorama. The panorama actually consists of a flat bitmap that encloses the scene, but when viewed with the Panorama Viewer, the view appears to be 3D.

Set up the scene:

1. From the `|tutorials|adv_lighting` directory, open `library_with_radiosity.max`.

The File Load: Units Mismatch dialog appears.

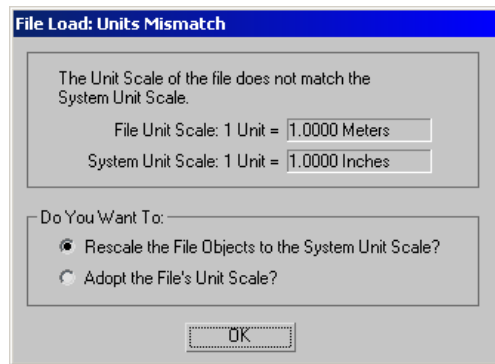

This scene was created with meters as the system unit. This dialog appears every time you open such a file, unless you have previously set meters to be the system unit in the current 3ds Max session. You can either adopt meters as your system unit, or you can rescale the scene geometry to match your current unit settings.

In this case, you will rescale the file. For the purposes of the tutorial, it doesn't really matter.

2. In the File Load: Units Mismatch dialog, make sure Rescale The File Objects To The System Unit Scale is selected, then click OK.

Render a panorama:

1. Choose Rendering > Panorama Exporter.

3ds Max displays the Utilities panel, with the Panorama Exporter rollout active.

2. On the Panorama Exporter rollout, click Render.

The Render Setup dialog appears. Settings on this dialog are similar to those on the regular Render Scene dialog.

3. On the Interactive Panorama Exporter Common Parameters rollout, click to set the solution to 1536x768.

Unless you are creating a quick, low-quality test, we recommend you render a panorama with high resolution. The default resolution of 512x256 is very grainy indeed.

4. Make sure *Camera.View.PI* is the active Viewport (in the list at the lower-left of the dialog), and then click Render.

Important: This drop-down list shows only cameras. A panorama is always based on a camera view. If no camera is in the scene, you can't render a panorama.

3ds Max renders the panorama in multiple passes, and then displays the Panorama Exporter Viewer.

Even at the high resolution, the panorama is not as detailed as a still-image rendering.



Tip: Before you render, you can save the panorama to a file. On the Interactive Panorama Exporter

Output rollout, find the Render Output group and click the Files button. Enter a name for the file, and choose one of the image file formats. The panorama is a single bitmap, but distorted for viewing in 3D.



Flat view of a rendered panorama

View the panorama:

1. Move your mouse near the center of the Panorama Exporter Viewer window, and hold down the left mouse button.

The panorama rotates, as if the camera were panning or tilting.

You can control the direction of the pan or tilt by dragging the mouse in that direction.

2. Experiment with navigating the panorama. You can right-click and then drag to rotate or tilt the camera. If your mouse has a middle button or wheel, you can use this to zoom in or out.

Note: The Panorama Viewer is modal. When it is displayed after rendering, you can't close the Render Setup dialog until you close the Viewer. You can also open the Viewer by clicking Viewer on the Panorama Exporter rollout on the Utilities panel. Use the Viewer's File menu to open a rendered panorama file.

Summary

The Panorama Exporter is a 3ds Max utility. Based on a camera view, you can render a 3D panorama and view it interactively using the Panorama Exporter Viewer.

F/X

Particles

Creating Cigarette Smoke

In this tutorial, you use a particle system to create a stream of cigarette smoke trailing from an ashtray. The animation relies on space warps to affect the movement of the smoke. For example, you use a Wind space warp to model the fan in the scene blowing the smoke around.



Animation techniques used in this tutorial:

- Creating a particle system.
- Creating space warps that affect the motion of the particles.
- Choosing appropriate particle geometry.
- Creating a material that models smoke when applied to particles.

Time to complete: 30 minutes

Set up the scene:

- Open *cigarette_smoke.max*.

Files for this tutorial are in the *tutorials\simple_particle_effects* directory.

Note: All the necessary files to do the tutorials can be found on the Tutorial Files CD that ships with 3ds Max 8. Before doing the tutorials, copy the *tutorials* directory from the CD to your *3dsmax8* local installation.

The scene contains a simple table, an ashtray, and a fan. To make the animation easier to adjust, the fan's geometry (except for the fan motor) is frozen.

Create the particle system:

1. Activate the Top viewport.



2. If you need to, select the ashtray and click Zoom Extents Selected to fit the ashtray in the viewport.



3. In the Create panel, make sure Geometry is active, and choose Particle Systems from the drop-down list.
4. On the Object Type rollout, click Super Spray.
5. In the Top Viewport, click and drag in the ashtray near the tip of the cigarette object.

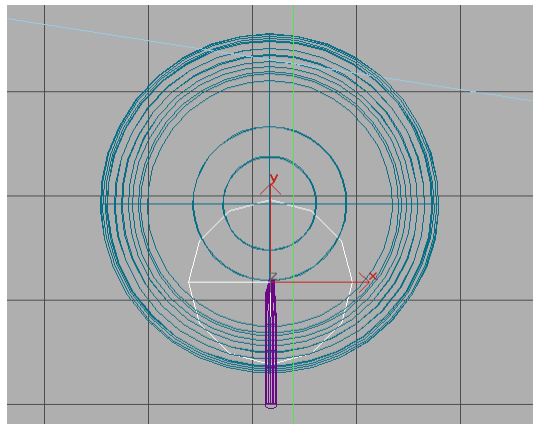

Super spray particle system in the Top viewport

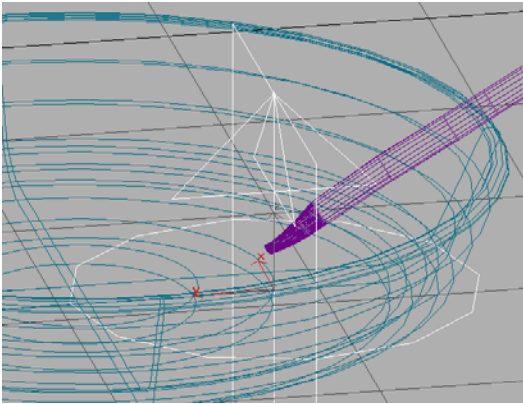

Super spray particle system in a user view

You have now created a Super Spray particle system. The icon you see is called the *emitter*. The emitter doesn't render, but it shows the location in the scene where particles will be emitted. The arrow points up, indicating that initially particles will move upward out of the center of the icon.

When you create a Super Spray system, the particles are emitted toward you in the viewport you click. That is, they move along the Z axis in the positive direction. This is why we used the Top viewport to create the system.

(Different kinds of particle systems have differently shaped emitters, and different emission behavior.)

-  Activate the Camera02 viewport, and then click Play.

A burst of particles leaves the emitter rapidly, moving in a vertical line. Each particle is displayed as a plus sign or "tick." By frame 40, all of the particles have moved out of the frame. This doesn't look much like smoke.

You are seeing the default behavior and settings for Super Spray. To get a more smoke-like effect, the first thing to do is adjust the Super Spray parameters.

Slow the particles down and make them easier to visualize:



1. With the Super Spray particle system selected, go to the Modify panel.

Tip: Particle systems have a large number of rollouts. If you like, you can expand the command panel to see more rollouts and controls at once. Move your mouse to the border between the command panel and the viewports, and drag the command panel to create multiple columns. The command panel can be widened whether it is floating or docked. To dock or float a command panel, right-click to one side of the tabs, and choose Float or Dock from the flyout menu.

2. In the Basic Parameters rollout > Viewport Display group, change the display type to Dots rather than Ticks.

For the purpose of working in viewports, especially when particles are very close together, Dots give a better preview than the plus-sign Ticks.

3. In the Basic Parameters rollout > Particle Formation group, set the Spread value for Off Axis to **2.0**.

(This is the Spread spinner immediately below the Off Axis spinner, and not the Spread value associated with Off Plane.)

4. In the Particle Generation rollout > Particle Motion group, set Speed to **1.5**.

Now if you play the animation, you see the particles stream upward more slowly. The slight increase in the Spread value means they don't move in a completely straight line. (Spread is measured in degrees. Higher Spread values create a more fan-like pattern.)

However, the particles stop emitting at frame 30 and completely disappear from the scene at frame 100. To get a smoke effect, you also need to change

the default values that govern particle generation and lifetime.

Adjust particle generation:

1. In the Particle Generation rollout > Particle Quantity group, set Use Rate to **30**.

This increases the number of particles generated per frame from 10 to 30.

Note: When you play the animation in the Camera02 viewport, you don't see 30 particles being emitted per frame. By default, in viewports, Super Spray displays only 10 percent of the particles actually being emitted. This keeps viewport playback fast. You can adjust the preview value in the Viewport Display group of the Basic Parameters rollout, but we recommend you keep it low. Previewing a large percentage of particles in a system can seriously slow down 3ds Max. When you render the animation, the rendering uses the full number of particles.

Tip: A better way to preview the effect of all particles is to use the command Rendering > Make Preview.

2. Also on the Particle Generation rollout, in the Particle Timing group, set both Emit Stop and Display Until to **300**.

The animation is 300 frames long. Setting Emit Stop to 300 means that particles continue to be emitted throughout the animation. Setting Display Until to the same value means that all particles that haven't died remain in the scene until the end of the animation.

3. Continuing down, set the Life value to **180**.

A particle in this system dies 180 frames after it is emitted. Not all of the particles will last until frame 300.



Now the particles emerge in a denser cloud that doesn't move right out of the scene. This is more

reminiscent of smoke. But the movement of the particle system still looks artificial.

Adding Wind, Turbulence, and Drag

Particles are not smart. Like sheep, you need to herd them. Space warps such as Wind and Gravity add directional fields that affect particle motion. In this simulation of cigarette smoke, you'll associate the fan with a Wind space warp that models the breeze from the fan.

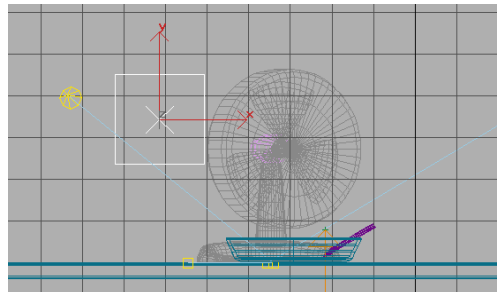

Create a wind space warp to simulate a breeze from the fan:

1.   Go to the Create Panel and turn on the Space Warps button.
2. Make sure Forces is the active space warp type.
3. In the Object Type rollout, click Wind.
4. Drag in the Left viewport to create the Wind space warp.



Wind space warp created in Left viewport (facing away from user)

Position the wind space warp:

-   Activate the Top viewport. Using Rotate and Move transforms, align the Wind space warp roughly to that of the fan. The arrow should point in the direction of the particles.

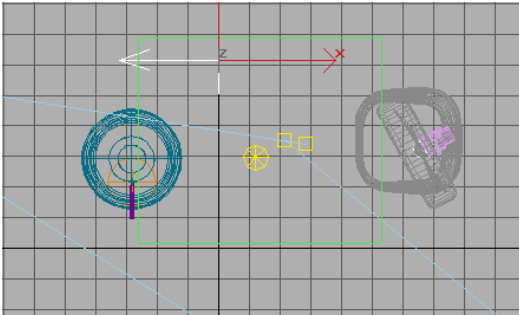

Wind space warp in Top viewport, before aligning to fan

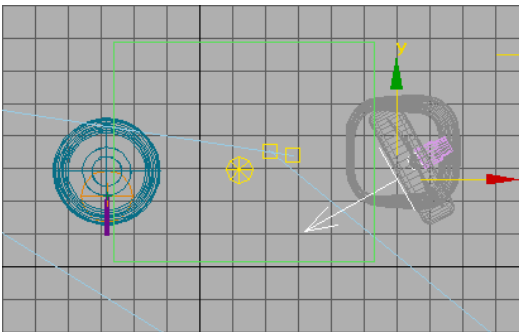

Wind space warp in Top viewport, after aligning to fan



You don't have to be too accurate about aligning the Wind icon with the fan motor. The wind direction, and linking it to the motor's motion, are the important things.

Link the wind to the fan so their motion is coordinated:

-  With the Top viewport still active and the Wind space warp still selected, click Select And Link, then drag from the Wind space warp to the *FanMotor* object.

Now if you play the animation, the Wind space warp rotates with the oscillating fan. Nothing has changed the animation of the particles. They are unaffected by the Wind space warp until you explicitly bind them to it.

Bind the wind space warp to the smoke particles:

1.  Select the Super Spray particle system.
2.  Click Bind To Space Warp, then click the Super Spray system, and hold the button down as you drag to the Wind space warp.



When Bind To Space Warp is active and the cursor is over a selected object, the cursor changes to the space warp icon to inform you that this object can be bound to a space warp. Then when you drag from the object to the space warp, a line is drawn to show which object is being bound. Once off the object, the cursor changes again until it's over a suitable space warp. Then it reverts to the space warp icon to inform you that this binding is legal. When you release the mouse, the bound space warp briefly highlights to indicate the binding is complete.

3.  Activate the Camera02 viewport, then play the animation.

The effect of the wind is much too strong. The smoke is whipped around dramatically.



Adjust the strength of the wind:

By default, the Wind space warp's Strength value is 1.0. Reducing the Strength value makes the effect of the fan look more realistic.

1.  Select the Wind space warp.
2.  In the Modify panel, set the Strength value to **0.03**.
3.  Activate the Camera02 viewport, then play the animation.

The smoke is more gently wafted now. But you can make the smoke's appearance more realistic still, by giving it a bit of inertia. To do so, you use another space warp.

Add a drag space warp:

1.   Go to the Create panel and click the Space Warps button.
2. Make sure Forces is the active space warp type.
3. On the Object Type rollout, click Drag.
4. In the Top viewport, drag to create a Drag space warp near the Super Spray.

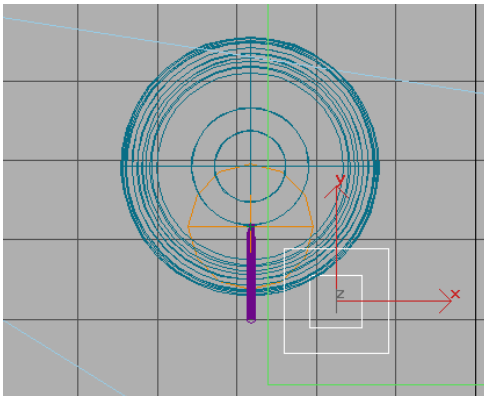

Drag space warp created in the Top viewport

Set the drag space warp parameters:

The Drag space warp has a large number of parameters. For the purposes of this animation, you need to set only a few of them: Time Off, and the Axis percentages for Linear Damping.

1.  With the Drag space warp selected, go to the Modify panel. Set Time Off to **300**.
By default, the Time Off value is 100, but you need Drag to be active for the duration of the animation.
2. With Linear Damping the active damping type, set the X and Y Axis percentages to **1.0**, and the Z Axis percentage to **2.0**.

As with Wind, the Drag space warp doesn't affect the particles until you bind them to it.

Bind the drag space warp to the smoke particles:



1.  Click Bind To Space Warp, then in the Top viewport click the Super Spray system, and hold the button down as you drag to the Drag space warp.

Now a drag force is applied to the particles. The force is non-uniform: there is more drag along the Z-axis (up and down in the scene) than in other dimensions.

2.  Activate the Camera02 viewport, then play the animation.
The effect of the Wind space warp is decreased. The Drag warp slows down the particles.

Add turbulence to the wind:

The smoke looks better, but its motion is still unnaturally uniform. The solution is to make the Wind more turbulent.

1.  Select the Wind space warp.
2.  On the Modify panel, go to the Wind group box in the Parameters rollout. Set Turbulence to **0.03**, Frequency to **0.12**, and Scale to **0.1**.

The Turbulence value controls how much the particles are perturbed from their position. Frequency causes random variation in the turbulence, and Scale adjusts the size of the turbulence field.

Why such low values? Actually, a good rule of thumb for turbulence settings is to start very low and work your way up. Turbulence creates a fractal noise field that is localized to the Wind space warp icon. The scale of this field needs to match the scale of your scene. The easiest way to do this is to start with low values and then increase them as needed.

3.  Activate the Camera02 viewport, then play the animation.

The particles move much more like cigarette smoke, with wispy sways and curls.

Also, the particles are blown in the current direction of the Wind space warp on a given frame. The effect is not conical with attenuation as it would be for an actual fan; instead, the effect of the wind and its turbulence is parallel.

Particle Geometry

While the movement of the smoke is now good, the particle geometry needs some adjusting.

Preview the particle system:

- Activate the Camera02 viewport, then choose Animation > Make Preview. A Make Preview dialog appears. Leave the settings at their defaults, and click Create. A Video Compression dialog appears. Use this dialog's default settings as well, and click OK.

When the preview completes, use Animation > View Preview to view it as an AVI movie.

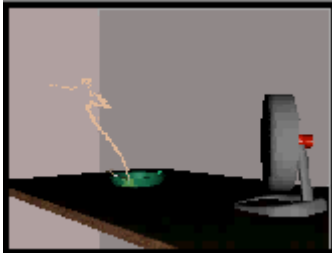

The particles still appear as a bunch of solid-looking dots (by default, they render as 3D triangles). To make them more convincing as smoke, first you adjust the particle geometry, then you apply an appropriate material to them.

Change the particle geometry:

1.  Select the Super Spray particle system.

2.  Go to the Modify panel.
3. If one of the space warp bindings is chosen in the modifier stack, click the Super Spray entry so you can see the particle system's rollouts.
4. In the Particle Type rollout > Standard Particles group, choose Facing.

Facings are square particles that are constantly oriented towards the camera. If you rendered them as solid, they wouldn't appear realistic, either. But facing particles are meant to have a material applied to them. When facings are clumped together and a material gives them a degree of transparency, you can achieve a fairly realistic smoke.

The size of the particles is uniform. In general, when you want realistically to model natural phenomena, you want to avoid uniformity.

Make the particle geometry more random:

Ideally, the particles should increase in size after they are born, and then fade out as they die. The Grow For and Fade For parameters let you do this. Also, to break up the unrealistic uniformity of the particle size, you need to add some variation to the size.

1. With Super Spray still selected and the Modify panel still active, go to the Particle Size group near the bottom of the Particle Generation rollout.
2. Set the Size to **2.0** and the Variation to **30 %**.
3. Set the Grow For value to **90** and Fade For to **30**.

In these last steps, you have increased the overall size of the particles and randomized this size by plus or minus 30 per cent. Each particle now grows for 90 frames, from an initial size of zero to the full size it will achieve. Thirty frames before it dies, it begins to shrink back down to a size of zero. (Remember that you have set each particle to live for 180 frames.)

Cigarette Smoke Material

Now that you've adjusted the particle geometry, you can shade the particles to look like smoke. The trick to this is to use a soft, partially transparent material that allows the particles to blend together and form a wispy smoke pattern. Because the particles are rendered as square facing geometry, a radial gradient with transparent edges can accomplish this.

Set up the material:



1. Open the Material Editor.
2. Choose an unused sample slot.
3. On the Blinn Basic Parameters rollout, click the Diffuse color swatch to display the Color Selector.
4. Set the Diffuse color to pure white (Value=255).
5. Set both the Specular Level and Glossiness values to 0.
6. Turn on the Self-Illumination Color check box. The Self-Illumination control changes from a spinner to a color swatch.
7. Click the Self-Illumination color swatch. In the Color Selector, set the self-illumination color to a medium gray (Value=144).
8. On the Shader Basic Parameters rollout, turn on the Face Map toggle.

Use Face Map shading with Facing particles, so that each rendered particle displays the entire map.

You now have a material that is pure white, partially self-illuminated with a medium gray color, and face mapped for particles.

Assign the material to the smoke particles:

-  Click Assign Material To Selection, or drag from the sample slot to the Super Spray particle system.

A rendering would show that the smoke is now more smoke-colored, but has hard, jagged edges from the square facing particles.



Smoke particles without transparency appear too solid and jaggy.

To soften the smoke, you create a radial gradient with transparency at its edges.

Make a radial gradient map for the smoke particles:

1. In the Material Editor, open the Maps rollout and click the Opacity map button.
2. In the Material/Map Browser, choose Browse From: New, click Gradient, and then click OK.
3. On the Gradient Parameters rollout, change the Gradient Type to Radial.
4.  Click Go To Parent to return to the base level of the material.
5. On the Maps rollout, change the Opacity Amount value to 5.

The Gradient map determines only five per cent of the opacity. Ninety-five per cent of the opacity is still controlled by the base Opacity parameter. For smoke, make the particles as

soft and semi-transparent as possible, especially with high particle counts. So the Gradient map should be the only thing that sets the Opacity of the particles, but you also want the overall Opacity to be very low. For this animation, you turn off the base Opacity value completely.

- In the Basic Parameters rollout, set the Opacity value to 0.

The rendered scene now has very soft smoke that rises up, grows gradually in size, and is blown around and perturbed by the wind from the fan.



The Final Animation

You are now ready to activate the Camera02 viewport and render the entire animation. Even at low resolution, this can take about half an hour. Alternatively, you can play the file *cigarette_smoke.avi*, provided on the Tutorial Files CD.

Creating an Explosion with Fragments and Bubbles

This animation shows a depth charge sinking towards a submarine, then exploding. One particle system generates the fragments, and another generates the bubbles. As in the previous particle systems tutorials, several space warps help control particle motion.



Animation techniques used in this tutorial:

- Using the PArray particle system's Object Fragments option to model fragments from the explosion.
- Using parameter wiring to control both geometry and lighting.
- Using PCloud, a particle system that emits particles from the volume of an object or an emitter icon.
- Adding fog and a volume light to enhance the atmosphere.

Time to complete: 60 minutes

Set up the scene:

- Open *sub_scene.max*.

Files for this tutorial are in the *tutorials\simple_particle_effects* directory.

Note: All the necessary files to do the tutorials can be found on the Tutorial Files CD that ships with 3ds Max 8. Before doing the tutorials, copy the *tutorials* directory from the CD to your *13dsmax8* local installation.

Some portions of the scene are already set up, including the animation of the submarine and the depth charge. The depth charge already has an Omni light and a Gravity space warp linked to it. These don't yet affect the rendered scene.

Exploding the Depth Charge

You will use PArray to emit particles from the surface of the depth charge. PArray has an option to generate particles out of fragments of the emitter object, so it's suited to model explosions.

Create the particle array:

-  On the Create panel, click Geometry, then choose Particle Systems from the drop-down list.
- Click PArray, then drag in the Top viewport to create the PArray icon.

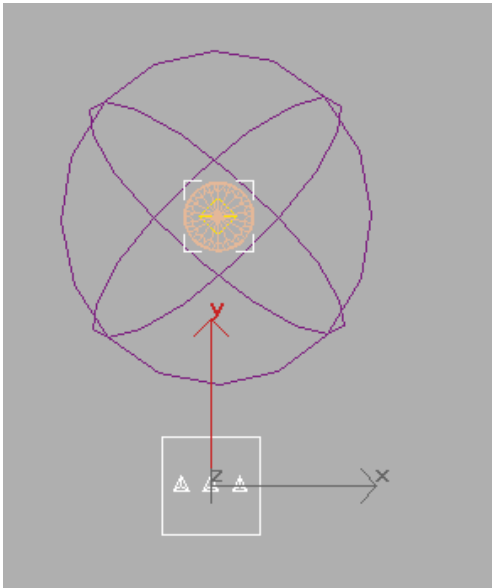

PArray created in Top viewport, near depth charge

Adjust the particle array parameters:

-  With the PArray selected, go to the Modify panel.
- At the top of the Basic Parameters rollout, click the Pick Object button, and then select the *DepthCharge* object by clicking it in a viewport.

Now PArray is set to use the *DepthCharge* object as an emitter. You need to adjust the emission parameters to synchronize them with the animation.

- In the Particle Generation rollout, set the Emit Start value to **200**, Display Until to **301** (just after the last frame in the animation), and Life to **101**.

These values guarantee that the emitted particles will remain in the scene for the duration of the animation.

- In the Particle Type rollout, set the particle type to Object Fragments.
- Just below, in the Object Fragment Controls group, choose Number Of Chunks (as opposed to All Faces, which is the default), and then set Minimum to **50**.

At this point, if you preview the animation in a viewport, you can see that particles are blasted out of the depth charge at frame 200. However, you can't see any fragments. PArray is still using the default viewport display setting of Ticks. You can change this to Mesh to see the geometry in viewports.

- Go to the Basic Parameters rollout, and in the Viewport Display group, choose Mesh.

Now if you play the animation in a viewport, you'll see the actual fragments displayed on particle emission. This is a fairly good preview of how the fragments will appear when you render.

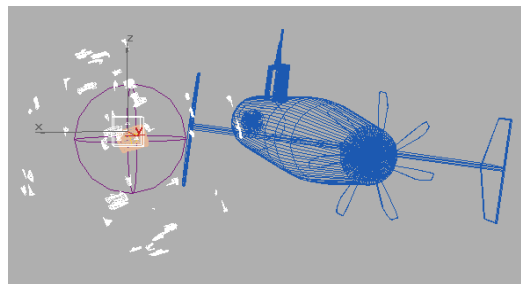



Fragment particles in a wire view

Though this isn't apparent in wireframe viewports, the depth charge object has a Visibility track that turns it off after frame 200. This is a standard technique for exploding objects.

At this point, the motion of the fragments would be appropriate for a space scene, but not for underwater. They don't rotate or sink, nor do they slow down after they're emitted. This is a subtle point, but it destroys the sense of scale in the scene.

To fix these problems with the fragment motion, you will use three space warps: a Drag space warp to dampen the particles' velocity, a Gravity space warp to cause the particles to sink in the water, and the Gravity space warp that's already linked to the depth charge object, to temporarily suck the particles inward after the explosion.

Add a drag space warp to slow the depth charge fragments:

1.   On the Create panel, click Space Warps, and select Forces from the drop-down list.
2. Click Drag, and then drag in the Top viewport to create a Drag space warp.

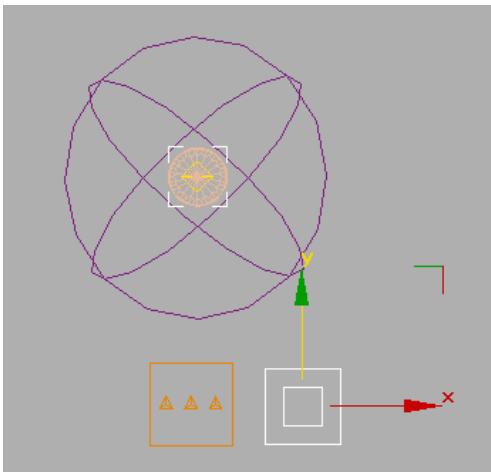

Drag space warp created in Top viewport

Adjust the drag space warp parameters:

1.  With the Drag space warp selected, go to the Modify panel.
2. In the Timing group, set Time On to **200** (when particles are born) and Time Off to **300** (when the scene ends).
3. In the Damping Characteristics group, Linear Damping should be chosen by default. Adjust the X Axis, Y Axis, and Z Axis values to **5.0** %.

Add a gravity space warp to make the fragments sink:

1.   Go back to the Space Warps section of the Create panel. Click Gravity, and then drag in the Top viewport to create the Gravity space warp.

By default, this Gravity space warp is planar.

2. Set the Gravity space warp's Strength value to **0.01**.

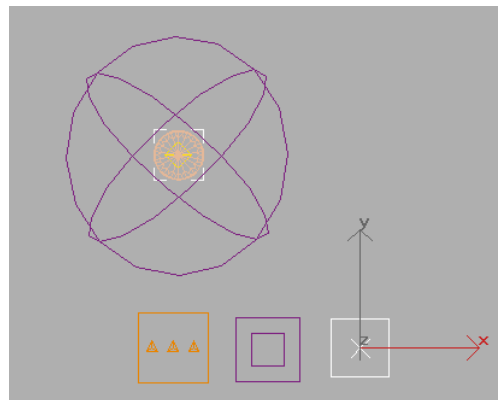

Gravity space warp created in Top viewport (pointing away from user)

Bind the space warps to the PArray:

1.  Click Bind To Space Warp.
2. Drag from the PArray particle system to the Drag space warp, then release the mouse

button. The Drag space warp should briefly highlight to show that the binding is complete.

3. Drag from the PArray particle system to the planar Gravity space warp, then release the mouse. Like the Drag warp, the Gravity warp should briefly highlight.
4. Drag from the PArray particle system to the spherical Gravity space warp that surrounds the depth charge object, then release the mouse button.

Tip: If you aren't sure that a bind operation succeeded, you can always check the particle array's modifier stack. After these bindings, the PArray stack should look like this:

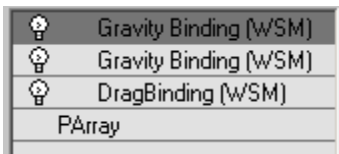

Now if you preview the animation, you see that the particles explode outward from the depth charge but quickly slow down (water is denser than air). Then they are sucked inward toward the depth charge (the explosion collapses from the pressure of the surrounding water), and finally they begin to sink.

Using Wiring for Animation

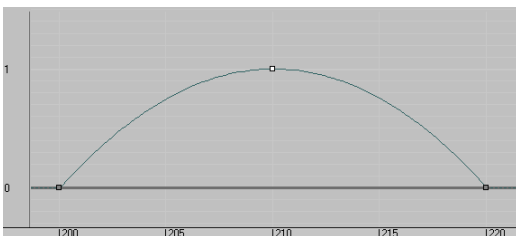

The particles are sucked inward toward the explosion source, but only for a short time. This is because the Strength parameter of the spherical Gravity space warp is animated.



Function curve for the Strength parameter

With the parameter wiring feature, you can use the Strength animation to control the explosion itself (burning gas), and the light the explosion generates. Using the Gravity Strength to control all three components (fragment motion, explosion, and light) ensures that they are synchronized in the animation.

Create the geometry for the actual explosion, and wire it to the Strength parameter:

1.   Go to the Create Panel and click Geometry. Choose Standard Primitives from the drop-down list. Click Sphere, and then drag in the Top viewport to create a sphere of any size.
2.  Go to frame 200, and if necessary, move the sphere so it is centered on the *DepthCharge* object.
3. Right-click the Sphere, and choose Wire Parameters from the quad menu (in the lower-right Transform quadrant). A series of pop-up menus follows.
4. From the first pop-up menu, choose Object (Sphere) and then Radius.

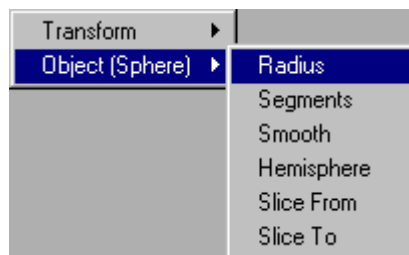

The pop-up menu goes away, and the cursor is now attached to a wiring line.

5. Move the mouse, with the wiring line following along, from the sphere object to the spherical Gravity space warp, and click. Another pop-up menu appears.

- From the new pop-up menu, choose Object (Gravity) and then Strength.

The Parameter Wiring Dialog appears. In this dialog, you can create relationships between parameters. These relationships can be directional, with one value influencing another, or bi-directional, allowing each parameter to influence the other.

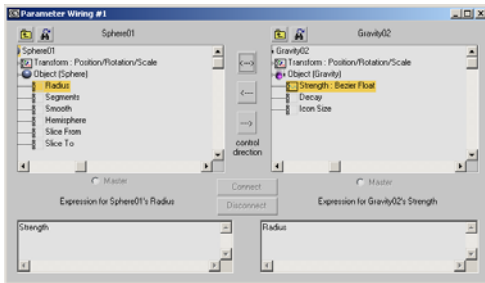

After you wire the sphere's Radius to the Gravity space warp's Strength, the dialog shows the first parameter in the upper-left window, and the second in the upper-right window.

The first thing you need to do is define the direction of the relationship; in this case, *from* the Gravity space warp's Strength value *to* the sphere's Radius value. You also need to modify the value. As you can see from the function curve, the Strength value ranges from zero to 1. The sphere that models the explosion must be larger than that. With parameter wiring, you can multiply the Strength value to obtain a larger value.

Choose the wiring direction and adjust the value:

- Click the Control Direction arrow that points to the left (from Radius to Strength).

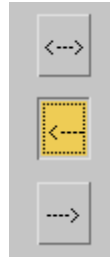

In the *Gravity02* expression text box, at the bottom of the dialog, *Radius* is grayed out. Strength will control the Radius, but the Radius will have no effect on Strength.

- In the text field for expressions (at the lower left, below the Sphere's tracks), append the text ***25** to the Strength variable. The final text in this window should read: Strength*25.

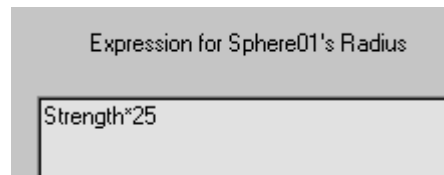

- Click Connect.

By adding a multiplier to the Strength value, the sphere will have a radius of 25 units when the Strength reaches 1. While Strength equals 0, the sphere has a radius of 0 and is invisible. At frame 200, it rapidly grows and then shrinks back to 0 by frame 220.

- Close the Parameter Wiring dialog.

Animate the illumination:

You'll use the same technique to animate the Omni light that's linked to the depth charge object. Currently it has a Multiplier value of 0 and casts no light. By wiring the Strength value to the Omni light's Multiplier, the light will grow and fade in unison with the growth and shrinking of the sphere.

1. Press **H** to display the Select Objects dialog. Choose *Omni01* in the list, and then click Select.
2. Right-click the Omni light and choose Wire Parameters from the quad menu.
3. In the first pop-up menu, choose Object (Omni Light) and then Multiplier.
4. Drag the wiring line from the Omni light to the spherical Gravity space warp (*Gravity02*), and click the space warp.
5. In the second pop-up menu, choose Object (Gravity) and then Strength.
6. In the Parameter Wiring dialog, click the control direction arrow that points to the left. You have now connected the Strength value to the Multiplier value.
7. In the Multiplier's expression window, append ***200** to the Strength variable so that it reads: Strength*200.
8. Click Connect.

Now the Omni light's Multiplier, like the radius of the sphere, is tied to the Gravity space warp's Strength. When the Strength increases, so does the power of the light.

Note: As a general lighting technique, usually you don't want to increase a light's Multiplier too much, because this washes out colors. In the case of the explosion, however, washing out color is exactly what you want to do.

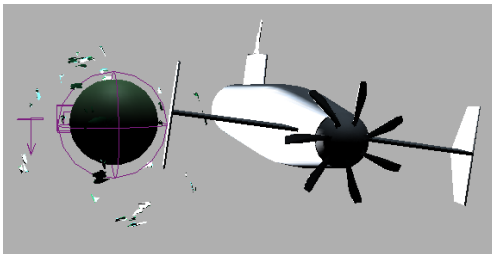



9. Close the Parameter Wiring dialog.

If you preview the animation in a shaded viewport, you see that the depth charge explodes into fragments, a sphere grows outward then shrinks to nothing, and the Omni light flashes on then off.

Creating Bubbles from the Explosion

A blast of bubbles from the explosion enhances the realism of the animation. To create the bubbles, you use PCloud, a particle system that emits particles from the volume of an object or an emitter icon.

Create the particle system to model the bubbles:

1.   On the Create panel, click Geometry, then choose Particle Systems from the drop-down list.
2. Click PCloud, then drag in the Top viewport to create a PCloud emitter. After releasing the mouse button, click again to set the emitter height (like creating a Box).
3.  With the PCloud selected, go to the Modify panel. In the Viewport Display group of the Basic Parameters rollout, change Percentage Of Particles to **10 %**.
4. Go to a frame where the sphere is visible.
5. In the Particle Formation group, choose Object-based Emitter (changing from the default, which is Box Emitter).
6. In the Object-Based Emitter group, click Pick Object, and then select the sphere.

You have now assigned the sphere to be the PCloud emitter. Particles will be emitted not from the surface of the object, but instead from within its volume.

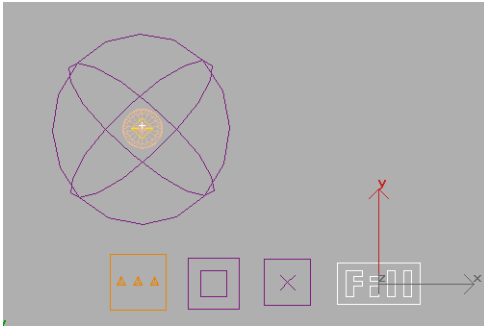

PCloud created in Top viewport, after assigning the sphere as its emitter

Next, you need to set a few basic parameters.

Adjust the bubble settings:

1. On the Particle Generation rollout > Particle Quantity group, make sure the Particle Quantity radio button is set to Use Rate.
2. In the Particle Motion group, set the Speed value to **1.0**. Choose Direction Vector (instead of Random Direction), then set the X value to **0.0** and the Z value to **0.5**.

This tells the bubble particles to emit at a constant rate (which you will change in a later step) and speed along the Z axis: in other words, vertically within the scene.

3. In the Particle Timing group, set the Emit Start to **210** and Emit Stop to **260**. Set the Display Until value to **301**, and the Life value to **101**.

Particles are emitted from frame 210, which is the peak of the explosion, to 260, after the explosion has ended, and they live for the remainder of the animation.

Set up the bubble geometry:

1. On the Particle Generation rollout, in the Particle Size group, set Size to **3.0**, Variation to **25.0 %**, and Grow For to **30**.

This causes the particles to grow from size 0 to size 3, with 25 percent random variation, over the first 30 frames of their life.

2. On the Particle Type rollout, change the Standard Particles setting to Sphere.

This sets up the particles to render as spheres.

Use parameter wiring to control the emission rate of the bubble particles:

1. Go to frame 211 so the sphere is visible. Right-click the PCloud icon, then choose Wire Parameters from the quad menu.
2. From the first pop-up menu, choose Object (PCloud) and then Birth Rate.
3. Move the wire line to the sphere, and click the sphere.
4. From the second pop-up menu choose Object (Sphere) and then Radius.
5. In the Parameter Wiring dialog, click the Control Direction arrow that points left (from the Sphere object to the PCloud object; the names are above the parameter lists).
6. In the box under the PCloud's parameters list (current contains "Radius"), change the Birth Rate's expression to read **1+(Radius*5)**.

This expression accomplishes two things:

- The value of Radius, 0 to 25 to 0, doesn't give us as many bubbles as we want, so we multiply it by 5, just as earlier we obtained the radius by multiplying the Gravity space warp's Strength.
- Over the period of emission, from frame 210 to 260, we want particles to be emitted. But the Radius returns to 0 at frame 220. So adding 1 to the value ensures that particles will be emitted at a rate of 1.0 from frames 220 to 260.

7. Click Connect.
8. Close the Parameter Wiring dialog.

The power of creating relationships with parameter wiring is that instead of keyframing all of the tracks by hand, you can create a dependency on

certain tracks so that when you change one, the rest follow. This can make animating and adjusting complex scene much faster and easier.

Finally, you'll add turbulent motion to the bubbles to enhance their realism. To do this, you'll use a Wind space warp with turbulence but no strength.

Add turbulent motion to the bubbles:

-  On the Create panel, click Space Warps and choose Forces from the drop-down list.
- Click Wind, then drag in the Top viewport to create the Wind space warp.

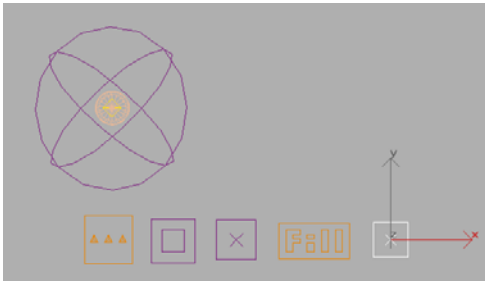

Wind space warp created in Top viewport

-  With the Wind space warp selected, go to the Modify panel. Set Strength to **0.0**, Turbulence to **0.02**, Frequency to **0.12**, and Scale to **0.07**.

Setting the Strength to zero turns off the directional force of the wind, but the turbulence settings are still active.
-  Click Bind To Space Warp.
- Drag from the Wind space warp to the PCloud particle system (or vice-versa), then release the mouse button.

If you play the animation at this point, you see the depth charge explode into fragments as a spherical explosion blows out and then sucks inward as

bubble particles are emitted from it. These bubbles float slowly upward in a turbulent fashion.

Assigning Transparent Materials

At this point, both the explosion itself and the bubbles would render as solid objects. To make them appear as gas in water, you assign materials.

Assign pre-made materials to the effects in your scene:

- Go to a frame where the explosion sphere is visible in viewports.
-  Open the Material Editor.
- Select the Explosion material in the upper-left sample slot and drag it onto the sphere.

The Explosion material uses maps to create a translucent material with a lot of self-illumination.
- Select the Bubbles material, to the right of the Explosion material, and drag it onto the PCloud particle system.

The Bubbles material is simply a Standard material with a light blue color and advanced transparency settings (found on the Extended Parameters rollout). The transparency settings include opacity falloff, which makes the bubbles look hollow, and additive opacity, which brightens colors behind the bubbles.

- Close the Material Editor.

Enhancing the Atmosphere

The final touches to the animation are to add a Fog atmosphere to the scene, making the water look murky, and a Volume Light atmosphere to the Omni light, making the light from the explosion diffuse throughout the water, as if reflected by particles in the water.

Add the fog:

1. Choose Rendering > Environment to open the Environment and Effects dialog.
2. On the Atmosphere rollout, click Add.
3. In the Add Atmospheric Effect dialog, choose Fog from the list, then click OK.
4. On the Fog Parameters rollout, click the color swatch, and use the Color Selector to specify a dull blue color: Red=**131**, Green=**166**, Blue=**178**.
5. In the Standard group of the Fog rollout, change the Far value to **75 %** and turn on Exponential.

Add the volume light:

1. Press **H** to display the Select Objects dialog. Choose *Omni01* in the list, and then click Select.
2.  Go to the Modify panel, and open the Atmospheres & Effects rollout.
3. Click Add.
4. In the Add Atmosphere Or Effect dialog, choose Volume Light from the list, then click OK.
5. Go back to the Environment dialog and in the Atmosphere rollout choose the Volume Light entry.
6. On the Volume Light Parameters rollout, set Density to **3.0**.

The Final Animation

You are now ready to activate the Camera01 viewport and render the entire animation. Even at low resolution, this can take about half an hour. Alternatively, you can play the file *sub_scene.avi*, provided on the Tutorial Files CD.

Further Animation

If you played the animation, you might have noticed that the camera appears to shake when the depth charge explodes. This is an "easter egg" in *sub_scene.max*. Specifically, a Noise controller has been assigned to the Z Position track of the camera target, making it shake between frames 200 and 219.

Summary

These tutorials show how the non-event-driven particle systems in 3ds Max, while not as sophisticated as Particle Flow, are capable of a wide range of effects, including a stream of smoke drifting in the air, water gushing from a fire hydrant onto the pavement, and a depth charge blowing up upon impact with a submarine. They also show how to apply forces such as wind and drag to particle streams, and to use parameter wiring to automatically animate different effects in concert to create more convincing particle animations.

Modeling Whipped Cream

BlobMesh is a compound object in 3ds Max that creates a set of spheres from geometry, shapes, or particles, and connects the resulting mesh together as if the spheres were made of a soft substance.



When the spheres are animated and come within a certain distance of one another, they connect together. When they move apart, they become spheres again.

BlobMesh is particularly powerful with particle systems such as Particle Flow, where you can use it to make the particles appear thick and viscous.

Here, you will use an existing particle flow animation, and add BlobMesh to the particles to make them look like a thick, liquid substance.

Set up for this lesson:

1. Open the file *tut_blobmesh_start.max* from the *tutorials/blobmesh* folder.



This file contains animation of a can of whipped cream spraying particles onto a bowl of strawberries.

2. Play the animation.



The particles are tetrahedrons. There are deflectors on the strawberries, the bowl, and the tabletop, and the particles are set up to stop moving when they hit any deflector.

Create the blobmesh:

1.   Choose Create panel > Geometry > Compound Objects.
2. Click BlobMesh, and click anywhere in the scene to create one blobmesh sphere.
3.  Go to the Modify panel.
4. In the Parameters rollout > Blob Objects group, click Add. Select *PF Source 01*, then click Add Blobs.

This adds the particles to the blobmesh object.

5. Play the animation.

The particles are replaced by blobs. The blobs obtain their sizes from the particle sizes.

In the viewport, some of the smaller particles will appear not to be surrounded by blobs. This is because BlobMesh uses a different level of detail for viewports and renderings.

6. Press **M** to open the Material Editor. Select the material named Whipped Cream, and drag it over *BlobMesh01* in the scene.

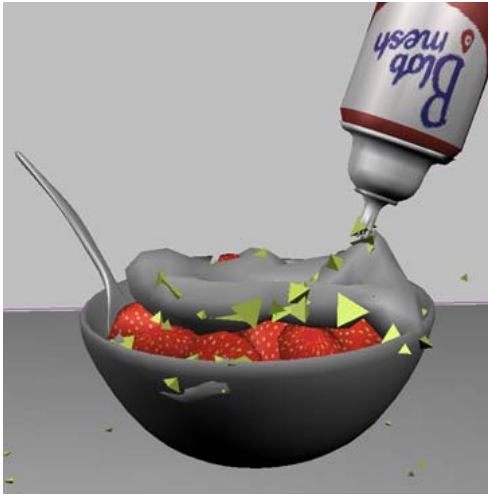

The whipped cream changes in the viewport when the material is assigned to it.

7. Render a frame to see how the blobs look in the final rendering.



Tip: You can add a Relax modifier to the *BlobMesh01* object to make the blobs look softer.

You can find a finished version of this scene in the file *tut_blobmesh_finish.max*. You can also see an animation created with this scene in the file *tut_whippedcream.mov*.

Summary

The BlobMesh compound object provides an easy way to make soft, liquid substances, especially when used in conjunction with a particle system.

Lens Effects

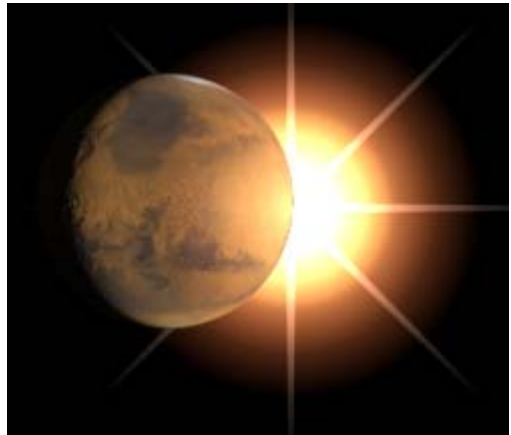

In this tutorial, you'll create a glowing sun using Lens Flare, Glow, and Star.

Skill Level: Intermediate

Time to complete: 30 minutes

Features Covered in this Tutorial

- Creating and manipulating a camera viewport
- Using omni lights to light your scene
- Creating and manipulating a Glow lens effect
- Using multiple Glow lens effects to create an ambient lighting effect
- Creating and manipulating a Ring lens effect
- Creating and manipulating a Star lens effect

Tutorial Files

All the necessary files to do the tutorials can be found on the Tutorial Files CD, in the *tutorials\lens_flares* folder. Before doing the tutorials, copy the *tutorials* directory from the CD to your *3dsmax8* local installation.

Adding a Camera View

Set up your scene:

Files for this tutorial are in the *tutorials\lens_flares* directory.

1. On the File menu choose Open, and then choose *tut_marsandsun.max*.
2. Activate the Top viewport and zoom out.
3.  On the Create panel, click the Cameras icon and click Target in the Object Type rollout.
4. Click near the bottom of the Top viewport, drag toward Mars, and release.

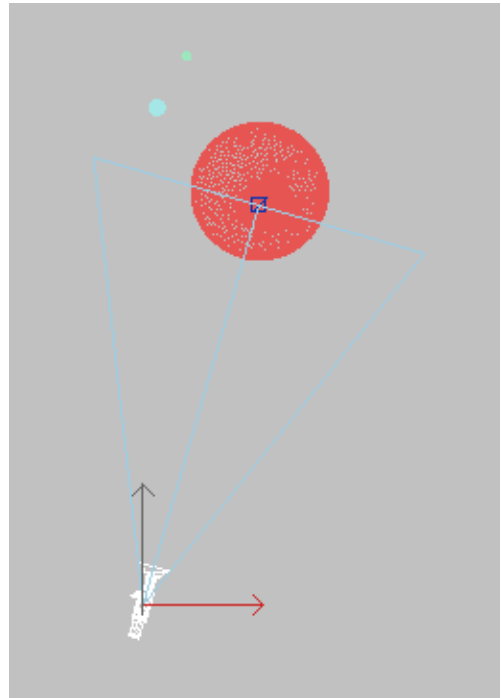

This creates a target camera pointing at the center of Mars.

5. Activate the Perspective viewport. Change it to a camera viewport by pressing **C**.
6.  Click Truck Camera. In the Camera viewport, pan the viewport to the left so there is space for the sun on the right side of Mars.

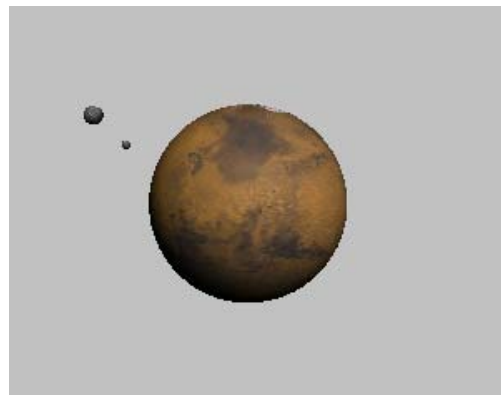

Adding Lights

There are no lights in the scene. In this step, you'll add two Omni lights: one to light Mars, and the other to be the Sun.

Light your scene:

1. From the Create menu, choose Lights > Standard Lights > Omni.
2. In the Top viewport, click to create an Omni light to the right and below Mars. Name it **marslight**.
3. Create a second omni light to the right and above Mars. Name it **Sun**.

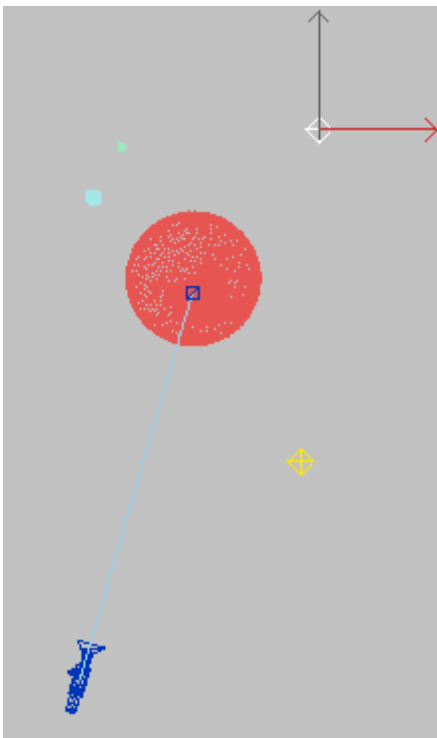

4. Select *Sun* and at the top of the Modify panel, click the color swatch. The Color Selector appears. Change the color to a yellow-orange and click OK.

Note: Both lights are adding illumination to the scene. With the camera in front of Mars, the lighting of the sun doesn't really add to the illumination on the dark side of the planet. If this becomes a problem later, you can exclude this light from illuminating any objects in the scene.

5. Move *marslight* left or right to create a lighting effect you like for the dark side of Mars.

Now use contrast to add some drama to your light.

6. In the Modify panel, go to the Advanced Effects rollout > Affect Surfaces group, and increase the Contrast setting for *marslight* to **77**.

You won't see the changes until you render the scene.



7. Activate the Camera viewport, then on the toolbar, click the Quick Render button.



You still don't see the light that will be your Sun in the rendered image. It won't appear until you add effects in the next topic.

Tip: Try different contrast values and render each one. The higher the value, the sharper the edge of the light.

Adding a Glow to the Sun Using Lens Effects

In this topic, you'll create a simple glow effect and add a ring and a star effect to it. This will allow the Sun to glow in the sky above the planet.

You can add as many different effects as you like to create the sun's glow. Try this effect, and then experiment with others.

Create a glow effect:

1. In the Camera viewport, select the Omni light named *Sun*.
2. Go to the Modify panel and click the Atmospheres & Effects rollout title to open it.



3. Click the Add button. The Add Atmosphere Or Effect dialog appears.

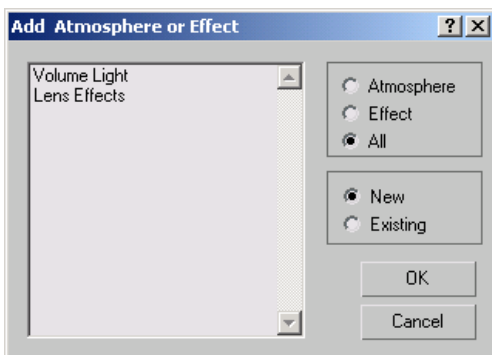

4. In the list, click Lens Effects, and then click OK.

Lens Effects is now listed in the Atmospherics and Effects window.



5. Click the Lens Effects name in the window and click Setup.

The Environment and Effects dialog appears.

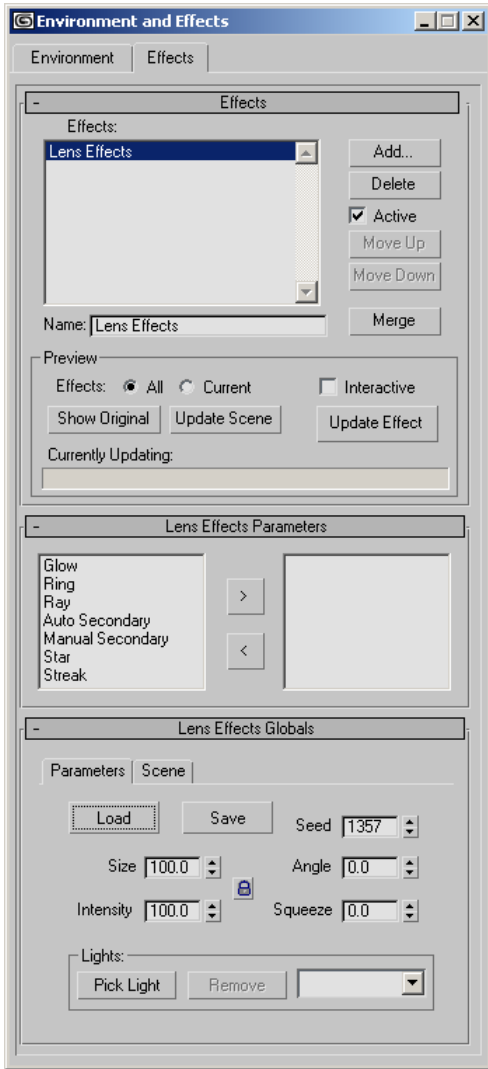

6. In the Name field, name this lens effect **Sun**.

The name is changed in the windows in the rollout and the dialog.

7. In the Preview group, turn on Interactive.

A rendered frame window appears. This lets you see the lens effect as you make changes.

Tip: You should turn off Interactive when working in a complex scene, but it's useful for experimentation.

8. On the Lens Effects Parameters rollout, choose Glow in the list on the left. Click the right arrow to move the effect into the list on the right.

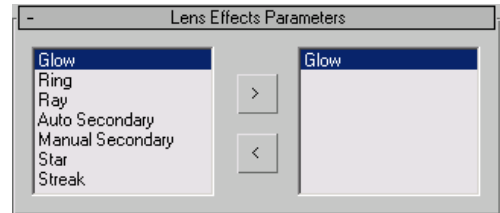

After a brief delay, the light source appears as a glowing sphere in the virtual frame buffer.

9. Scroll down to the Glow Element rollout. In the Name field, enter **Main Sun**.

To change the look of your Sun, try the following settings in the Glow Element rollout:

- Set Size to **50.0**.
- Set Intensity to **200.0**, producing a very bright glow.
- Set Use Source Color to **50.0**.
- In the Circular Color group, set Mix to **50.0**, giving the Sun a soft red glow.

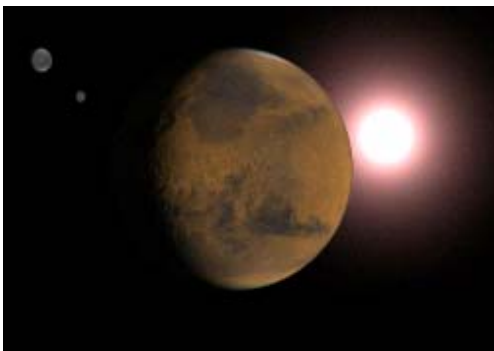
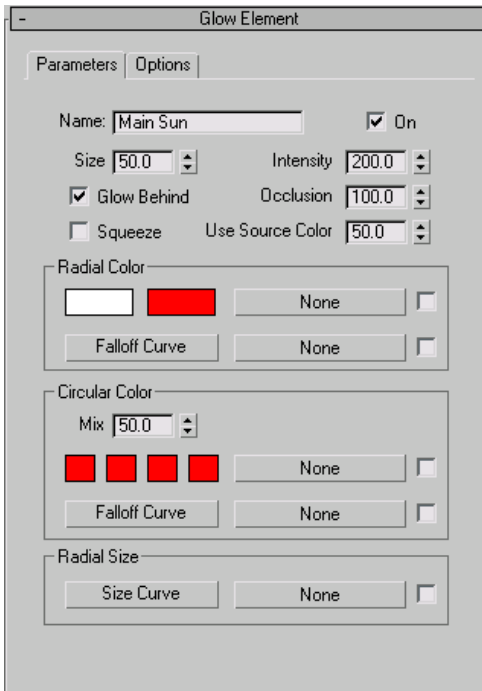

Tip: With Interactive on, you'll get faster results by changing numeric settings with the keyboard, rather than using the spinners.

Adding a Ring Effect

Now you'll add a ring effect to the Sun's glow.

Enhance your sun with a ring effect:

1. In the Effects tab of the Environment and Effects dialog, scroll up to the Lens Effects Parameters rollout. Choose Ring and move it to the list on the right. A ring appears around the Main Sun in the Effects Preview window.

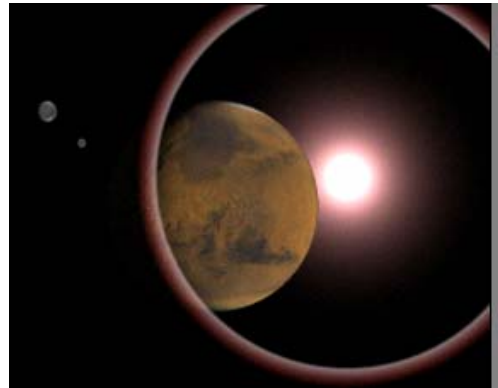

2. Scroll down to the Ring Element rollout and make the following settings to define the ring:

- Set Size to **22.0**.
- Set Thickness to **33.0**, giving the ring more of a glowing perimeter.
- Set Use Source Color to **50.0**.

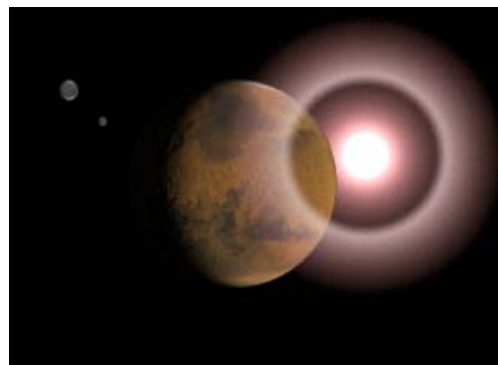

These changes make the ring more dramatic-looking, but it still needs some intensity to make it look like a glowing Sun.

Adjust the ring effect:

By increasing the intensity of the main glow and juggling the size and thickness of the ring, you can control the size of the white-hot center of the sun.

1. Increase the intensity of the Ring Element to **133.0**.
2. Lower the size of the ring to **14.0**.
3. Increase the thickness of the ring to **65.0**.
4. Turn on Glow Behind to place the glow from the Sun behind the planet.

Now the Sun looks more realistic.

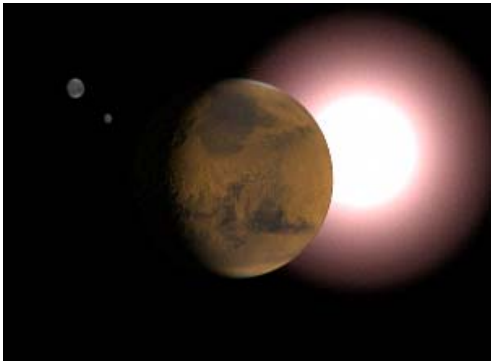

Adding a Star Effect

Now you will add a star effect to the Sun's glow.

Add a star effect to your sun:

1. In the Effects tab of the Environment and Effects dialog, scroll up to the Lens Effects Parameters rollout. Choose Star from the effects list and move it to the list on the right. A Star effect appears over the Main Sun in the Effects Preview window.

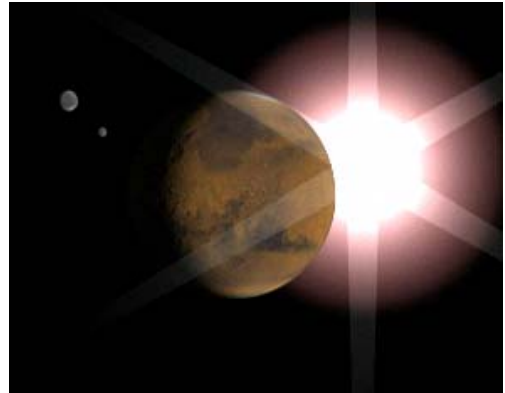

2. Scroll down to the Star Element rollout, and set the following:
 - Set Qty (the number of points in the star) to **8**.
 - Set Intensity to **50.0**
 - Set Sharp to **5.0**.
 - Turn on Glow Behind.
 - Experiment with Width and Taper before setting them to **1.0** and **0.1**, respectively.

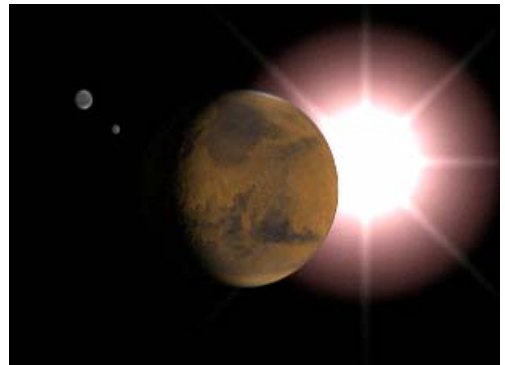

You might find that your effects are incorrect if the Sun moves behind the planet. You can fix this by adjusting the effect's Occlusion settings.

Improve the star effect by adjusting occlusion settings:

1. In the Camera viewport, move the *Sun* omni light so it's just on the edge of the planet.
Because Interactive is turned on, the rendered frame window updates automatically.
2. Go to the Lens Effects Parameters rollout and select *main sun* from the right-hand window.
3. Scroll down to the Glow Element rollout and set Occlusion to **0.0**.
4. Return to the Lens Effects Parameters rollout and select Ring from the effects list in the right-hand window.
5. Scroll down to the Ring Elements rollout and set Occlusion to **0.0**.

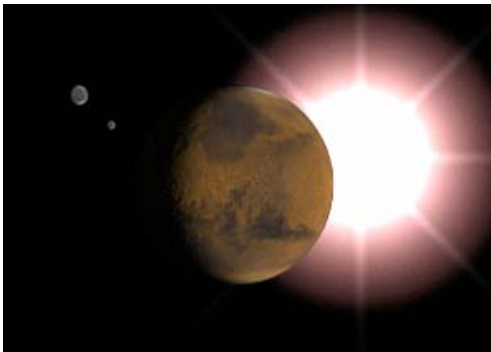

Adding Another Glow

The effects you've added to the Sun have included the Glow Behind option, so they are not adding a glow to the planet, which is in front of the light. Now that your Sun is glowing in the sky, you need to add glow to the planet itself.

Add a second glow to your scene:

1. Select the planet in a viewport. Right-click and choose Properties in the Transform quadrant of the quad menu.

2. In the Objects Properties dialog > G-Buffer group, change Object Channel to **1** and click OK to close the dialog.

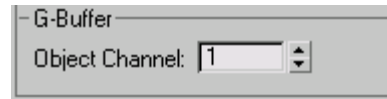

3. In the Environment and Effects dialog > Lens Effects Parameters rollout, add another Glow to the list of effects.

Note: If you closed this dialog you need to select the *Sun* omni light and click Setup on the Atmospheres & Effects rollout.

4. In the Glow Element rollout, rename this effect **Glow on Planet**.
5. Click the Options tab and in the Image Sources group, turn on Object ID.

Notice that the number is set to 1 by default.

The planet now renders with a bright white glow. This is too intense.

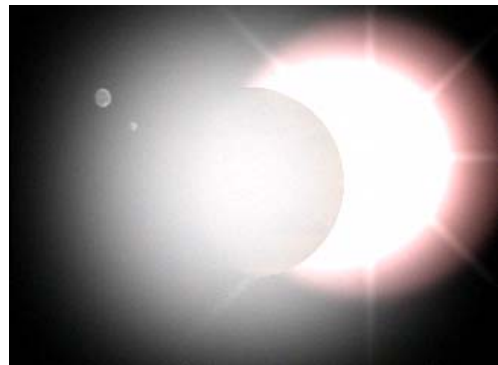

6. Click the Parameters tab. Set Occlusion to **0.0** and turn off Glow Behind.
7. Change Intensity to **45.0** and Source Color to **50.0**.
8. In the Radial Color section, change the white color swatch to a darker brick red.

The planet is looking better now.

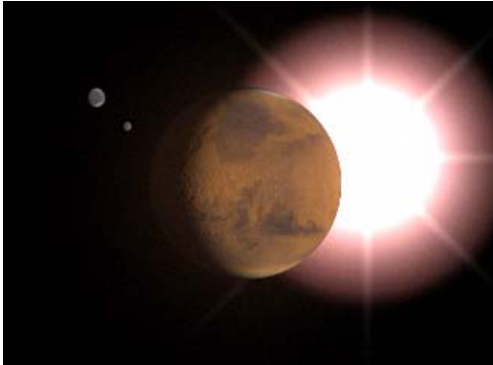

Tip: If the planet is still shadowy, move the *marslight* closer to the planet in the Top viewport.

Make global adjustments:

On the Lens Effect Globals rollout, you can make global adjustments to control the whole effect.

1. Experiment to see what happens when you change Size to **11.0**, **22.0**, and **33.0**.

As an additional exercise, try animating the effects' settings.

2. Save the scene as **mymarsandsun.max**.

Summary

This tutorial has shown how to create Glow, Ring, and Star lens effects, and how to adjust their settings. It also showed how multiple Glow effects can create the effect of ambient lighting, how to create and navigate a camera viewport, and the use of omni lights for scene illumination.

index

Index

Symbols & Numerics

- 2D camera screen points - assigning for camera match 3-121
- 2D sketch as modeling template 2-1
- 3D camera points - placing 3-116
- 3D from 2D 2-1, 2-153
- 3D materials 1-166
- 3D Snap
 - positioning the apple stem and 1-112
- 3ds Max documentation 1-3

A

- active joint axes 2-70
- activeshade 3-8
- add clip
 - motion flow 2-607
- adding
 - extra limbs 2-600
 - smoke trails 2-912
 - stars to the sky 1-148
- adding buildings to a site plan 2-162
- adding freeform period to footstep animation 1-332
- adding material to terrain 2-158
- adding the arches 2-168
- adding the buildings 2-162
- advanced lighting override material 1-437, 1-446
- affect region modifier - applying to a pool table surface 3-133
- airplane
 - creating the gondola 1-68
 - creating the sponsons 1-61
 - creating the stabilizer and rudders 1-57
 - creating the wings 1-51
- alien
 - bones 2-337
 - character rig 2-349
 - skinning 2-425
- align
 - biped to mesh 1-386
- ambient color 1-119, 1-122
- analyzing animation
 - errors 2-634
- anger expression target - creating 2-481
- angle deformers 2-439
- animating 1-224
 - a ball 1-223
 - a character dancing 2-447
 - a character walking 2-452
 - a cue ball 3-126 to 3-127
 - a globe 3-3
 - a mound on a pool table surface 3-133
 - a pratfall 1-332
- asteroid 3-75
- beetle speaking 2-476
- behavior assignments 2-644
- biped with footsteps 1-294, 1-302
- biped with freeform animation 1-291
- carrying and dropping 2-530
- climbing a ladder 2-522
- crowds 2-638
- facial expression targets 2-481
- mechanical design 2-58 to 2-59
- pool table surface 3-132
- render effects 3-90, 3-92
- rotation changes 3-23
- spacefighter 1-241, 1-246
- still life 3-26
- still life objects 3-23
- using the move transform 1-223
- walk cycle with IK constraints 1-359
- watch 1-270
- with camera map 3-132 to 3-133
- with dummies 1-223

- animation
 - animated still life 3-16
 - animating a walk cycle for a character 2-452
 - character 2-576
 - character rigging 2-361, 2-377, 2-379
 - creating 1-255, 3-16
 - creating keyframes 1-270
 - creating track sets 1-270
 - daylight 1-434
 - dummies 1-255
 - dummy objects 1-230
 - freeform 2-576
 - ghosting 1-227
 - HI solver 2-361
 - IK 2-361
 - inheritance 2-377
 - keyframe 1-223
 - keyframing 1-224, 1-255
 - look-at controller 2-379
 - loop 2-612
 - mars 1-255
 - mirroring 2-335
 - play animation 1-224
 - quadruped 2-576
 - rendering 3-26
 - space station 1-255
 - suspension 2-64
 - synchronizing with video 3-126
 - wire parameters 2-379
 - animation controllers 1-237
 - copying 1-270
 - animation tracks 1-270
 - anisotropic shader 1-119
 - antialiasing and rendering quality 1-440 to 1-441
 - appearing and disappearing 3-85
 - apple
 - adding a stem to 1-112
 - applying skin to 1-106
 - creating 1-106
 - positioning 1-110
 - shaping 1-108
 - tapering 1-106
 - applied IK 2-74
 - apply an architectural material 1-169
 - applying
 - avoidance 2-644
 - logic to crowd behavior 2-646
 - arcade 2-176
 - Architectural Desktop
 - editing material definitions 2-149
 - sharing materials with 2-146
 - Architectural Desktop drawings
 - file link 2-139
 - import 2-139
 - architectural material 1-169
 - architecture
 - materials 1-155
 - area lights
 - mental ray renderer 2-838
 - area shadows 1-437
 - arms
 - applying a matte/shadow material to 3-130
 - creating a matte object for 3-129
 - rendering 3-130
 - array 2-12
 - assembly, luminaire 2-53
 - asset tracking
 - adding files to vaults 2-942
 - Asset Tracking Systems 2-937
 - checking files into vaults 2-944
 - checking out files from the vault 2-945
 - checking version history 2-945
 - creating new vaults 2-940
 - logging into vaults 2-941
 - modifying files 2-944
 - revising asset paths 2-938
 - working folders 2-942
 - asteroid 2-885, 3-28, 3-33
 - atmospheric effects
 - volume fog 3-10
 - volume light 3-10
 - attach to node 1-396
 - audiences 1-1
 - AutoCAD drawing (DWG) file 2-86
 - AutoCAD drawings
 - file link 2-82, 2-105
 - import 2-82
 - preparing for import 2-83
 - AutoCAD import 2-154
 - AutoCAD links 2-153
 - AutoCAD, importing 3D DWG files 2-101
 - Autodesk Vault 2-937
 - avi 1-432
 - avoidance behavior 2-644
- ## B
- background
 - movie 3-137
 - specifying the background for rendering 3-7
 - background - for camera match
 - checking the rendering resolution 3-119
 - displaying in the viewport 3-120
 - displaying using different files 3-120
 - setting up for rendering 3-118
 - background image 2-1
 - setting up 1-48
 - bake texture 2-293

- ball
 - animating 1-223
 - bouncing 1-230
- ballistic tension 1-319
- baseboard 3-62
- basic materials - creating/changing 1-119
- basic rendering 1-424
- basketball
 - biped interacting with 2-506
- batch render 3-72
- batch rendering 3-61
- beetle - speaking 2-476
- beginning user 1-1
- behaviors 2-638
- bend modifier 1-112
- bezier position 1-223
- binding kinematic chains 2-70
- biped
 - animating with footsteps 1-294
 - create 1-383
 - creating 1-282
 - euler rotations 2-502
 - freeform animation 1-291
 - function curves 2-502
 - posing 1-283
 - retargeting motion 2-493
 - skeleton 1-282
 - transferring animations 2-493
 - twist links 2-498
- biped retargeting
 - about 2-493
 - adjusting the animation 2-495
 - retargeting bipeds 2-494
 - retargeting limbs 2-494
- blending
 - forward and inverse kinematics 2-506
- blinn shader 1-119
- blobmesh 1-473
- bones
 - arms 2-345
 - bone tools 2-337, 2-342, 2-348, 2-361, 2-377, 2-379
 - character rigging 2-349
 - color 2-337
 - creating 2-300
 - creating and editing 2-337
 - hands 2-345
 - mirroring 2-335
 - renaming 2-337
 - rig 2-349
- boolean
 - creation 2-45
 - subtraction 2-45
- boolean subtraction 1-29, 2-168
- booleans
 - 2D 2-9
 - 3D 2-9
- bottle shape
 - applying multi/sub-object materials to 1-136
 - applying raytrace materials to 1-139
- box modeling 2-199
- boxes, using for a pool table surface 3-132
- bubbles - and particle systems 1-464
- bulge angle deformer 2-425, 2-439
- bump maps
 - normal 2-251
- C**
- camera
 - script 2-925
- camera constraint 1-276
- camera map modifier 3-125, 3-133
- camera match
 - about 3-114
 - adjusting the match 3-124
 - assigning 2D screen points 3-121
 - camera match points 3-139
 - checking the rendering background resolution 3-119
 - creating a camera for testing 3-121
 - displaying the background using different files 3-120
 - guidelines for using 3-115
 - installing the software driver 3-121
 - modifying camera position 3-121
 - placing CamPoints 3-116
 - placing the camera 3-121, 3-124
 - preparing the scene 3-115
 - selecting reference points 3-115
 - setting up a rendering background 3-118
 - setting up a viewport background 3-120
 - troubleshooting 3-124
- camera shader
 - mental ray 2-849
- camera tracker 3-136 to 3-137, 3-139, 3-144
 - loading the movie 3-141
 - matching a moving camera 3-146
 - smoothing and compositing 3-147
- cameras using for fly-by 2-180
- CamPoints 3-139
 - matching to the background image 3-121
 - placing 3-116
 - troubleshooting 3-124
- carrying and dropping motions 2-530
- caustics (reflective)
 - mental ray renderer 2-826
- caustics (refractive)
 - mental ray renderer 2-831
- channel info utility 1-204

- character
 - animation 2-446, 2-576
 - arms 2-345
 - assembly 2-447
 - bone tools 2-361, 2-377, 2-379
 - bones 2-337, 2-342
 - hands 2-345
 - head bones 2-348
 - legs 2-337
 - mapping 2-236
 - modeling 2-361, 2-377, 2-379
 - monkey head 1-92
 - multilegged 2-576
 - pelt mapping 2-243
 - quadruped 2-576
 - rigging 2-299, 2-361, 2-371, 2-377, 2-379, 2-383, 2-390 to 2-391, 2-447
 - skin pose 2-379, 2-390
 - spline IK 2-342
 - walk cycle 2-446
 - xref 2-446
- character modeling
 - low polygon 2-199
- character rig 2-349
 - IK solver 2-305
- character rigging
 - script controller 2-383
 - wrist twist 2-383
- character studio
 - included in 3ds Max 8 1-281
- chess set
 - modeling 1-21
 - modeling a bishop 1-29
 - modeling a knight 1-35
 - modeling a pawn 1-21
 - modeling a rook 1-31
- child overlap 1-400
- cigarette smoke 1-457
- climbing motion 2-522
- clip creation
 - motion flow 2-607
- clone object 2-47
- clone rendered frame window 1-439
- cloning 3-80
- cloning a door 3-107
- close-up of a head
 - lighting 1-415
- close-up shot 1-144
- cloth
 - tutorials 2-766
- cloth modifier 2-793
- collision effect 2-886
- color
 - changing 3-20
 - for pool table surface - selecting 3-132
 - of basic materials - changing 1-119
- columns, creating 2-2, 2-12
- comics rendering 1-215
- comparing trajectories 2-623
- compound object
 - boolean 2-45
- compound rigid bodies 2-686
- connection rollout
 - mental ray 2-856
- constraints and controllers 1-246
- contour shading
 - mental ray renderer 2-856
- contours and NURBS head 1-93
- control point 1-400
- controller
 - bezier position 1-223
 - changing controller types 1-237, 3-3 to 3-4
 - character rigging 2-321
 - noise 1-223, 1-237
 - position list 1-223, 1-237
 - weighted list 1-223
- controllers
 - applying to multiple biped objects 2-631
 - applying using Workbench 2-631
- controlling in-betweens 1-227
- converting a shape to 3D geometry 3-129
- converting footstep to freeform 1-332
- cool material - identifying 1-118
- coordinate system, local 2-42
- copy
 - motion 2-614
- copy object 2-47
- courseware 1-3
- crash and splatter effects 2-885
- create
 - biped 1-383
- create camera from view 3-124
- creating
 - a boolean 2-45
 - a cylinder 2-42
 - an architectural material 1-169
 - crowd of swimming bipeds 2-657
 - distinctive walk 1-303
 - explosion 2-904
 - illusion of weight 2-534
 - layers 3-95
 - motion flow script 2-608
 - objects in AutoCAD 2-86
 - particle system 2-905
 - simple freeform animation 1-344

- terrain 2-156
- the museum building 2-2, 2-9, 2-17
- creating skin material 1-151
- crowd
 - with animated non-biped objects 2-649
- crowd animation 2-638
- cue ball - animating 3-126 to 3-127
- Curve Editor 1-223, 1-230
 - function curve 1-227
 - keyframes 1-229
 - parameter curve out-of-range types 1-229
 - Track View 1-227
- curves (Track View), animating a ball with 1-230
- custom attributes
 - character rig 2-317, 2-321, 2-349
- cylinder - creating 1-112

D

- daylight
 - animation 1-434
 - daylight system 1-448
- decay parameter - adjusting 1-110
- deformable bodies tutorial 2-719
 - cloth 2-719
 - deforming meshes 2-737
 - ropes 2-728
 - soft bodies 2-731
- delete
 - operator (particle flow) 2-915, 2-921
- DEM files 2-182
- depth of field (DOF)
 - mental ray renderer 2-822
- design visualization 1-169, 1-448, 2-1, 2-12, 2-58, 2-153
- DGS material shader
 - mental ray 2-863
- dielectric material shader
 - mental ray 2-867
- diffuse color - changing 1-119
- displace modifier 1-110
- displacement effect - adjusting 1-110
- displacement mapping 1-144
- display proxies 2-689
- distortion shader
 - mental ray 2-854
- DOF (depth of field)
 - mental ray renderer 2-822
- doors
 - animating 3-108
 - applying materials to 3-104
 - cloning 3-107
 - creating 3-101
- Dope Sheet editor 1-236
- Dope Sheet mode 1-236
- drawing (DWG) file, editing a 2-86

- drawing files
 - missing maps 2-117
 - origin setting 2-117
 - smoothing 2-117
 - thickness setting 2-117
 - troubleshooting 2-112 to 2-113, 2-117
- drawing lines 1-21
- drivers
 - switching 3-121
- dummy objects
 - animation 1-230
 - linking a ping-pong ball to 1-230
- dwf
 - export 2-79
- DWF
 - exporting 2-78
- dwf viewer 2-80
- dwg 2-133
- DWG files 2-86
 - file link 2-82, 2-105, 2-139
 - importing 2-82
 - linking 2-139

E

- e-learning 1-3
- ear
 - modeling 1-101
- edit
 - AutoCAD drawings 2-86
 - drawing (DWG) file 2-86
- edit normal
 - modifiers 1-90
- editable patch modifier - modeling facial expression
 - targets 2-481
- editable poly 1-78, 1-80, 2-199
- editable polygon
 - bevel 2-24
 - chamfer 2-31
 - convert 2-24
 - cut 2-24
 - extrude 2-24, 2-31
 - slice 2-24
- editing
 - motion flow 2-606
 - with layers 2-626
- enclosure 3-98
- envelopes 2-426
 - adjusting 1-400
 - overlapping 1-404
- environment shader
 - mental ray renderer 2-860
- errors
 - finding and fixing 2-634
- euler rotations 2-502

- explosions 1-464, 2-904, 2-919, 3-74
 - adding light 3-87
 - and particle arrays 3-82, 3-84
- export 2-133
- exporting
 - DWF 2-78
- exposure control 1-448
- expression target 2-481
- extrude modifier 3-129
- eyedropper - selecting materials with 1-115
- eyes
 - modeling 1-98
- F**
- facial expression
 - creating with the morpher modifier 2-475, 2-481
 - modeling with the editable patch modifier 2-475, 2-481
 - targets for 2-481
- fall - animating 1-332
- fast skin shader 2-874
- FFD modifier 2-476
- figure mode 1-386
- file link 2-133
- File Link 2-132
- file link manager 2-133
 - Architectural Desktop materials 2-146
 - linking drawings 2-105
- File Link Manager 2-137
- file link to drawing (DWG) files 2-82, 2-105, 2-139
- film and broadcast 2-925, 3-1
- filters
 - using 2-628
- final gathering
 - mental ray renderer 2-835
- find target test (particle flow) 2-904, 2-910 to 2-911
- Finishing the Plane 1-76
- fixing animation
 - errors 2-634
- fixing drawings 2-112 to 2-113, 2-117
- fixing DWG files 2-112 to 2-113, 2-117
- FK - using with IK 2-446
- flames effect 2-902
- flare effect 3-14
- flex 1-223, 1-240
 - secondary motion 2-444
- flips 1-319
- floors
 - adjusting tiles with UVW map modifier 1-180
 - materials 1-174
- flying a camera around the design 2-180
- flying the spacefighter 1-241
- foliage 2-182
- foot
 - pinning to objects 2-511
- footstep animation
 - bipeds 1-294
- footsteps 1-302
 - and IK keys 1-341
- force operator (particle flow) 2-921
- forward kinematics 2-64
 - blending with IK 2-506
- foundation, creating a building 2-9
- fracture 2-696
- fragments - and particle systems 1-464
- freeform
 - animation 2-576
- freeform animation
 - animating bipeds 1-291
- freeze layers 2-168
- G**
- game production 2-293
- garment maker modifier 2-793
- getting started with crowds 2-638
- getting started with design visualization 3-93
- ghosting frames, changing 1-223
- gizmos - adjusting 1-110
- glass material
 - mental ray 2-862
- glass, creating 2-12
- global illumination 1-437
 - mental ray renderer 2-835
- globe
 - material 3-1
 - rotating 3-1
- glow 1-481, 3-88 to 3-90
- glowing objects 1-446
- Goco character head 1-92
- gondola - airplane 1-68
- gravity effect 2-889
- grid - setting up 3-129
- groups
 - animating 2-638
- gymnastic motion flips 1-319
- H**
- hand
 - pinning to object 2-506
- hand animating with reactor 2-694
- head
 - modeling 1-93, 1-97, 1-102, 1-105
- HI solver
 - arms 2-371
 - shoulder 2-391
- hiding unselected objects 1-106, 1-112
- hierarchical linkage 1-223

- hierarchical subdivision surface modifier 1-89
- hierarchy 2-134
- high frequency data 2-624
- hinge from edge tool 1-80
- hips
 - envelopes 1-404
- hot material - identifying 1-118
- hub, revolving door 3-95
- I**
- IK
 - mirroring 2-335
 - solver 2-305
 - with FK 2-446
- IK blend 2-506
 - with feet 2-511
 - with hands 2-506
- IK chain
 - parent space 2-305, 2-335
- IK object
 - using with feet 2-511
 - using with hands 2-506
- importing
 - 3D AutoCAD models 2-101
 - 3D DWG files 2-101
 - an AutoCAD file 2-82 to 2-83, 2-154
 - drawing files 2-82
 - DWG files 2-82
 - motion capture data 2-621
- in place mode 2-546
- in-between 1-223
- ink 'n paint material 1-215
- install 1-3
- installing drivers 3-121
- installing the software driver 3-121
- instanced geometry 2-905
- instanced lights 1-419
- interactive IK 2-73
- interior materials 1-155
- interpolation 1-230
 - changing 1-223
- introduction 1-1
 - to materials and mapping 1-114
- introduction to rendering 1-424
- introductory tutorials 1-1
- Inventor interoperability 2-125
 - importing assemblies 2-127
 - importing assemblies with materials 2-128
 - mesh resolution option 2-125
 - vertical axis direction, controlling 2-130
- inverse kinematics 2-64
- inverse kinematics - mirroring 2-335
- iron
 - biped interacting with 2-506

- J**
- joint angle deformer 2-425, 2-439
- jpg 1-432
- jumping
 - and running 1-312
- K**
- keyframe animation
 - applying to a matte object 3-130
 - controlling in-betweens and 1-223
 - dummy objects and 1-230
 - move transform and 1-223
- keyframing
 - IK blend 2-530
- keys
 - for lip sync 2-481
 - for the cue ball - adding 3-127
 - reducing 2-628
- kinematics 2-64
- knife - applying raytrace material to 1-139
- knight chess piece 1-35
- L**
- ladder
 - animating climbing 2-522
 - biped climbing 2-506
- land planning 2-153
- landXML files 2-182
- laser blast 3-74
- layer manager 2-56
- layered animation 1-223, 1-237
- layers 2-134
 - use of 2-612
- layers, creating 3-95
- layout mode 1-230
- learning 3ds Max 1-3
- learning and training cd 1-3
- legs
 - envelopes 1-404
- lens effect 1-477
- lens flare
 - creating sun with 1-474 to 1-477, 1-479 to 1-481
- level design 2-264
 - adding mapping and materials 2-267
 - adding trees with object painter script 2-282
 - creating a building 2-265
 - merging content into a scene 2-272
 - painting vertex color 2-280
 - using xrefs to add streetlight 2-274
- light lister tool 1-419
- light tracer 1-437
- lighting
 - advanced lighting override material 1-437
 - area shadows 1-437

- close-up of a head 1-415
- global illumination 1-437
- light tracer 1-437
- radiosity 1-437
- spotlight 3-8
- lights
 - adding to a scene 1-409
 - adding to explosions 3-87
 - introduction 1-409
 - multiple instances 1-419
 - standard 1-452
- Limit Controller 2-187
- Link 2-137
- linked data 2-134
- linking 2-133
 - character rigging 2-311
 - DWG files 2-139
- linking drawing files 2-82, 2-105, 2-139
- linking to dummies 1-223
- lip sync 2-475
 - creating with the morpher modifier 2-481
 - expression targets 2-481
 - requirements for 2-481
 - setting keys for 2-481
 - with modifiers 2-476
- list controller
 - character rigging 2-321
- local coordinate system 2-42
- lofting 1-102
- logarithmic exposure control 1-448
- logic and crowd behavior 2-646
- lookat constraint
 - wiring weights 2-391
- loop
 - animation 2-612
 - motion flow 2-612
- looping 2-624
- low-polygon character
 - creating arms 2-219
 - creating boots 2-203
 - creating pants 2-208
 - creating the helmet 2-225
 - creating the neck 2-233
 - creating the oxygen mask 2-230
 - creating the torso 2-214
 - creating the visor 2-229
 - modeling 2-199
 - scene setup 2-200
 - smoothing 2-235
- luminaire 2-53
- M**
- managing
 - an Architectural Desktop file 2-139
 - drawing files 2-139
 - managing interior materials 1-155
 - map paths 2-132
 - mapped materials 1-159
 - mapping 1-141
 - adding to an object 2-267
 - characters 2-236
 - flat mirror 1-141
 - mapping coordinates 1-128
 - opacity 3-79
 - pelt 2-243
 - raytrace 1-139
 - reflection 1-141
 - synchronizing animated maps 3-80
 - mapscaler 2-135
 - mapscaler, object space 1-181, 1-186
 - mapscaler, world space 1-186
 - mask material 1-174
 - mass distribution 2-688
 - match camera to view 3-124
 - material
 - assigning to objects 3-7
 - skin 1-151
 - Material Editor 1-141, 3-1
 - materials 1-107
 - moving materials to 1-115
 - using 1-118
 - material operators
 - dynamic 2-918
 - material picker 2-135
 - materials 1-141, 3-104
 - about 1-115
 - adding mask material 1-174
 - adding to an object 2-267, 3-22
 - adding to terrain 2-158
 - and particle arrays 3-83
 - applying 3-133
 - applying in particle flow 2-918
 - architectural 1-169
 - assigning 3-1
 - assigning to objects 1-118
 - basic - creating 1-119
 - changing color 1-119
 - creating for explosion 3-78
 - exporting to Architectural Desktop 2-146
 - floor material 1-174
 - for architecture 1-155
 - for laser blast 3-75
 - getting from the scene or from 3ds Max files 1-115
 - hot and cool 1-118
 - ID numbers 1-136
 - in Architectural Desktop 2-149
 - ink 'n paint 1-215

- introduction 1-114
 - loading libraries 1-115
 - multi/sub-object 1-136
 - multiple materials to one object 1-162
 - of one color 1-155
 - raytrace 1-139
 - texturing the chessboard 1-141
 - translucent 1-221
- matte object
- applying a matte/shadow material to 3-130
 - creating 3-126, 3-129
 - keyframing 3-130
- matte/shadow material
- camera map animation and 3-133
 - creating and applying 3-130
- MAXScript 2-282
- camera manager 2-925
 - for effects 2-925
 - unhide 2-930
- mechanical design, animating 2-58 to 2-59
- mental ray
- camera shaders 2-849
 - contour shading 2-856
 - DGS material shader 2-863
 - dielectric material shader 2-867
 - distortion shader 2-854
 - environment shader 2-860
 - glass material 2-862
 - materials 2-862
 - mental ray material 2-863
 - night shader 2-852
 - ocean shader 2-871
 - submerge shader 2-871
 - using a shader as a map 2-846
 - water surface shader 2-871
 - wraparound shader 2-849
- mental ray connection rollout 2-856
- mental ray material
- mental ray 2-863
- mental ray materials 2-862
- mental ray renderer
- area lights 2-838
 - depth of field (DOF) 2-822
 - final gathering 2-835
 - global illumination 2-835
 - motion blur 2-818
 - reflections 2-810
 - reflective caustics 2-826
 - refraction 2-814
 - refractive caustics 2-831
 - sampling 2-806
 - trace depth 2-810
- mental ray shaders 2-867, 2-871
- merging content into a scene 2-272
- merging files 3-111
- mesh select modifier 1-108, 1-110
- metal shader 1-119
- mirror
- skin settings 2-426
- mirroring 1-102, 2-335
- modeling
- a bishop 1-29
 - a chess set 1-21, 1-29
 - a pawn 1-21
 - a rook 1-31
 - airplane 1-46
 - align 1-255
 - bones 2-361, 2-377, 2-379
 - dummy object 1-255
 - ear 1-101
 - editable poly 2-199
 - eye 1-98
 - facial expression 2-481
 - head 1-92 to 1-93, 1-97, 1-102, 1-105
 - improvements 1-78
 - level design 2-264
 - move/rotate/scale 1-255
 - planets 3-29
 - space scene 3-28 to 3-29
- modes
- in place 2-546
 - motion flow 2-607
- modifiers 1-78
- bend 3-4
 - cloth 2-793
 - editable patch 2-475
 - extrude 3-4
 - FFD 2-475 to 2-476
 - garment maker 2-793
 - hsds 1-89
 - mesh select 1-106, 1-108
 - morpher 2-475
 - parametric deformers 1-107
 - skin 2-426
 - spline IK control 2-330
 - surface 1-35
 - unwrap uvw 1-192
 - vertex weld 1-79
- modifying
- biped structure in figure mode 1-386
 - footsteps 1-312
- monkey head 1-92
- moon - creating for close-up shot 1-144
- morph
- morph objects and topology change 1-212

- morph targets
 - lip sync 2-481
- morpher modifier - creating lip sync and facial expression 2-481
- morphing animation 1-204
- motion
 - copy 2-614
 - random 2-617
 - transfer 2-614
- motion blur 3-86
 - mental ray renderer 2-818
- motion capture
 - importing data 2-621
 - layers 2-626
- motion flow
 - add clip 2-607
 - clip creation 2-607
 - editing 2-606
 - loop 2-612
 - script 2-608
 - shared 2-614, 2-617
 - tutorial 2-606 to 2-608, 2-612, 2-614, 2-617
- motion flow script
 - create 2-608
- motion mixer 2-547
- motion-capture
 - working with 2-621
- mound on pool table surface - animating 3-133
- mouth-shape targets for speech 2-481
- move transform, animating a ball with 1-223
- multi-layer shader 1-119
- multi/sub-object materials - applying to a label and bottle 1-136
- multilegged
 - character 2-576
- multiple booleans 2-171
- multiple delegates and behaviors 2-641
- multiple materials to one object 1-162
- multiplier curves 1-223

N

- naming
 - a sphere 3-20
 - selections 1-108
- new feature in v8
 - animation tracks 1-270
 - asset tracking 2-937
 - biped retargeting 2-493
 - cloth modifier 2-793
 - euler rotations 2-502
 - function curves on bipeds 2-502
 - garment maker modifier 2-793
 - Inventor interoperability 2-125
 - Limit Controller 2-187

- pelt mapping 2-243
 - twist links 2-498
 - vertex selection tools 2-442
 - Weight tool 2-435
- night shader
 - mental ray 2-852
- noise controller 1-223
- noise controller, adjusting 1-237
- nonlinear animation 1-223, 1-237
- normal bump maps 2-251
- normals 1-90
- NURBS
 - creating contours 1-93
 - creating ear 1-101
 - creating eye 1-98
 - head - completing 1-105
 - head - mirroring and lofting 1-102
 - head - previewing 1-97
 - modeling with 1-92

O

- object painter script 2-282
- object space mapscaler 1-181, 1-186
- object-space camera map modifier (OSM) 3-133
- objects
 - assigning materials to 1-118
 - available for modeling 3-16
 - matte objects 3-126, 3-129 to 3-130
 - parametric objects 3-16
 - primitive objects 3-16
 - unselected - hiding 1-106, 1-112
- ocean shader
 - mental ray 2-871
- online support 1-3
- online tutorials 1-4
- opacity value of basic materials - changing 1-119
- orange
 - applying basic materials to 1-119
 - creating orange 3-20
 - creating orange peel 3-20
- oren-nayar-blinn shader 1-119
- orientation constraint
 - character rigging 2-371

P

- painting - vertex color 2-283
- painting - with vertex color 2-280
- panorama exporter 1-455
- parameter collector 2-189
 - animating parameters 2-194
 - organizing 2-190
 - selecting parameters 2-190
- parameter out of range curves 1-223

- parameter wiring
 - character rig 2-317, 2-321, 2-349
 - character rigging 2-371, 2-391
 - parametric objects - types of 3-16
 - parent overlap 1-400
 - particle flow
 - with blobmesh 1-473
 - particle systems
 - and explosions 1-464, 3-82, 3-84
 - and materials 3-83
 - creating cigarette smoke 1-457
 - path constraint 1-276, 2-330
 - paths 1-242
 - pelt mapping 2-243
 - Perforce 2-937
 - performance, rendering 1-441
 - phoneme targets for speech 2-481
 - phong shader 1-119
 - physique
 - applying 1-396
 - getting started 1-382
 - problem areas 1-404
 - ping-pong ball
 - adding squash and stretch to 1-240
 - pivot points
 - character rigging 2-311
 - joining 1-112
 - repositioning 1-230
 - pivots 2-67
 - plane 3-76
 - planets
 - modeling 3-28
 - player
 - ram 3-138
 - pool table surface
 - animating 3-133
 - applying a material to 3-133
 - applying an affect region modifier to 3-133
 - creating 3-132
 - creating and animating 3-132
 - pose
 - biped 1-386
 - position constraint
 - wiring weights 2-371
 - position list controller 1-223, 1-237
 - pratfall 1-332
 - preview window 2-691
 - previewing NURBS head 1-97
 - previewing reactor 2-683
 - primitive objects 3-16
 - move/rotate/scale 3-29
 - props
 - biped using 2-506
 - prow and the spire 2-172
 - proxy geometry 2-685
- ## Q
- quadruped
 - animation 2-576
 - character 2-576
 - quaternion rotation 2-383
 - quick render 1-107
- ## R
- radial blur 3-92
 - radial scale 1-400
 - radiosity 1-437
 - advanced lighting override material 1-446
 - and camera animation 1-440
 - creating a radiosity solution 1-438
 - glowing objects 1-446
 - improving quality 1-443
 - radiosity mesh 1-440
 - speeding up 1-443
 - radiosity adaptive subdivision 3-61
 - advanced lighting 3-68
 - rag doll tutorial 2-700
 - creating the animation 2-718
 - hinge constraint 2-706, 2-708
 - making objects physical 2-702
 - rag doll constraints 2-712
 - setting up hips back neck and shoulders 2-716
 - setting up knees elbows ankles and wrists 2-708
 - ram player 1-432, 3-138
 - random motion 2-617
 - raytrace map type 1-139
 - raytrace materials - applying to a bottle and knife 1-139
 - reaction manager 2-467
 - reactor
 - accuracy 2-691
 - assigning physical properties 2-682
 - compound rigid bodies 2-686
 - create animation 2-695
 - creating a deforming mesh 2-737
 - creating animation 2-683
 - creating cloth 2-719
 - creating ropes 2-728
 - creating soft bodies 2-731
 - deformable bodies tutorial 2-719
 - display proxies 2-689
 - fracture 2-696
 - hand animation 2-694
 - introduction to 2-681
 - keyframing 2-695
 - preview window 2-691
 - previewing animation 2-683
 - proxy geometry 2-685

- rag doll tutorial 2-700
 - reducing file size 2-695
 - rigid bodies 2-682
 - rigid body collections 2-683
 - simulating mass distribution 2-688
 - simulation accuracy 2-691
 - simulation geometry 2-684
 - simulations 2-683
 - substeps 2-691
 - unyielding rigid bodies 2-694
 - updating 3ds Max 2-691
 - using proxies 2-685
 - real-world map scale 2-135
 - real-world map size 3-65
 - real-world mapping 3-61
 - reduce mesh memory footprint 1-204
 - reducing keys 2-628
 - reference points for use with camera match 3-114 to 3-115
 - reflected light
 - global illumination 2-835
 - reflections
 - mental ray renderer 2-810
 - trace depth 2-810
 - refraction
 - mental ray renderer 2-814
 - region-select technique 1-108
 - relax tool 1-202
 - Reload 2-137
 - rename objects 2-337
 - render effects 1-477, 1-479 to 1-481, 3-88 to 3-90, 3-92
 - render to texture 2-80, 2-293
 - rendering 1-224
 - an arm 3-130
 - and antialiasing 1-440 to 1-441
 - animations - using render scene 3-26
 - checking resolution of background - for camera match 3-119
 - creating a rendering 1-438
 - improving 1-441
 - introduction to 1-424
 - rendering daylight 1-448
 - setting up background - for camera match 3-118
 - speeding up 1-441
 - using environment 3-118
 - requirements for lip sync 2-481
 - resources 1-3
 - revit 2-133
 - Revit 2-132, 2-137
 - revit material 2-135
 - revolving door 3-95, 3-98, 3-101, 3-104, 3-107 to 3-108
 - rig
 - animation controllers 2-321
 - arms 2-371
 - custom attributes 2-317, 2-349
 - IK solver 2-305
 - legs and feet 2-349
 - pivot points 2-311
 - script controller 2-383
 - shapes 2-311
 - shoulder 2-391
 - skin modifier 2-325
 - wiring 2-317, 2-321, 2-349
 - wrist twist 2-383
 - rig - character 2-349
 - rigging
 - introduction 2-299
 - rigid body collections 2-683
 - rigid body properties 2-682
 - rigid vertices 1-400
 - ring effect 1-479
 - roof 2-165
 - roof, creating for museum 2-2
 - rotation - animating rotation changes 3-23
 - rotation boosting 2-628
 - rotation list 2-321
 - rotation smoothing 2-628
 - rotation windup 3-3
 - running
 - and jumping 1-312
- ## S
- sample files 1-3
 - sampling
 - mental ray renderer 2-806
 - scale operator (particle flow) 2-916
 - scaling maps in object space 1-181, 1-186
 - scaling maps in world space 1-186
 - scene state 3-61
 - scene states
 - restore 3-70
 - save 3-70
 - scenes, saving 1-282
 - schematic view 2-411
 - frozen objects 2-337
 - screen points - assigning in camera match 3-121
 - script
 - create 2-608
 - motion flow 2-608
 - use of 2-608
 - script controller
 - character rigging 2-383
 - scripting
 - camera manager 2-925
 - effects 2-925
 - unhide 2-930
 - secondary motion 2-444
 - seeking targets 2-904

- select region
 - circular 2-47
 - rectangular 2-47
 - selections - naming 1-108
 - self-illumination value of basic materials - changing 1-119
 - set key 2-452
 - shader
 - mental ray 2-846
 - shaders 1-119, 1-125, 1-221
 - shadow study 1-434, 2-18
 - shadows
 - choosing a shadow type 1-422
 - shape operators (particle flow)
 - shape facing 2-915
 - shapes
 - character rigging 2-311
 - shared
 - motion flow 2-614, 2-617
 - shock wave effect 2-892
 - shoulders
 - envelopes 1-404
 - simulating fractures with reactor 2-696
 - simulation accuracy 2-691
 - simulation geometry 2-684
 - site planning, conceptual modeling 2-162
 - site-specific design 2-153
 - skateboard
 - biped interacting with 2-506
 - skeleton
 - create 1-383
 - skin
 - applying to an apple 1-106
 - material 1-151
 - skin modifier 2-425 to 2-426
 - angle deformer 2-439
 - character rigging 2-325
 - skinning 1-396, 2-325
 - character 2-425
 - smoke trails effect 2-900, 2-912
 - smoothing
 - and compositing (camera tracker) 3-147
 - snaps 3-94
 - soft selection 1-29, 1-85, 1-108, 1-110
 - with flex modifier 2-444
 - software driver - installing 3-121
 - SourceSafe 2-937
 - spacing tool 2-12
 - spawning particles 2-912 to 2-913
 - special effects 2-925, 3-1
 - specular color - changing 1-119
 - speech target requirements 2-481
 - sphere 1-107
 - spheres
 - changing color of 3-20
 - creating 1-106, 3-20
 - naming 3-20
 - tapering 1-106
 - viewing 3-20
 - spline IK 2-330, 2-337, 2-342
 - spline IK solver 2-330
 - splines
 - placing around an arm 3-129
 - splines, drawing 1-21
 - split tests (particle flow) 2-893
 - sponsons - airplane 1-61
 - squash - adding to a ball 1-240
 - squash and stretch 1-223
 - stabilizer and rudders - airplane 1-57
 - standard lights 1-452
 - standard materials 1-155
 - standard primitives 3-16
 - star effect 1-480
 - stars 1-148
 - stem
 - adding to an apple 1-112
 - positioning with 3D Snap 1-112
 - still life
 - animating 3-26
 - creating 3-16
 - stop and start walking 1-317
 - strauss shader 1-119
 - streetlight using xrefs 2-274
 - strength parameter spinners - adjusting 1-110
 - stretch - adding to a ball 1-240
 - sub-object selections 1-108, 1-110
 - sub-surface scattering
 - fast skin shader 2-874
 - submerge shader
 - mental ray 2-871
 - substeps 2-691
 - substitute modifier 2-139
 - creating a substitute 2-141
 - support files 1-3
 - surface properties and displacement mapping 1-144
 - surface tools 1-35
 - sweep modifier 3-61 to 3-62
 - symmetry modifier 2-199
 - synchronizing animation with video 3-126
- ## T
- taper modifier 1-107
 - applying to a cylinder 1-112
 - applying to a sphere 1-106
 - targets for lip sync 2-481
 - TCB rotation 3-3

- terrain
 - adding materials to 2-158
 - creating 2-156
- text 3-4
- text - bending 3-1
- texture coordinates
 - managing 1-192
- texture mapping 1-202
- textures
 - texture baking 2-293
 - texture coordinates 1-193
 - texture mapping 1-193
- time tags - adding to video 3-126
- topology changes and morph objects 1-212
- trace depth
 - mental ray renderer 2-810
- Track View 1-223, 1-230
 - and setting lip sync keys 2-481
- training centers 1-3
- trajectories 1-223
- transfer
 - motion 2-614
- transitions
 - use of 2-612
- translucent shader 1-221
- transparency (materials) 1-119, 1-123
- trees 2-282
- troubleshooting - camera match 3-124
- troubleshooting drawing files 2-112 to 2-113, 2-117
- tutorial
 - motion flow 2-606 to 2-608, 2-612, 2-614, 2-617
- tutorial files cd 1-3
- tutorials 2-766
 - audiences 1-1
 - introductory 1-1
 - sample files 1-3
 - where installed 1-3
- twist links 2-498
 - adding 2-499
 - setting twist poses 2-499

U

- unhide
 - scripting 2-930
- uniform textures 1-181, 1-186
- units 3-94
- unwrap UVW 1-193, 1-202
 - mapping a character 2-236
- unyielding rigid bodies 2-694
- updates 1-3
- use of
 - layers 2-612
 - script 2-608
 - transitions 2-612

users

- beginning with 3D 1-1
- familiar with other 3D programs 1-2
- using
 - freeform animation 1-343
- using filters 2-628
- using in place mode 2-546
- UVW
 - mapping characters 2-236
- UVW map modifier, using to adjust floor tiles 1-180
- UVW mapping 1-193

V

- vaults
 - adding files 2-942
 - checking in files 2-944
 - creating 2-940
 - logging in 2-941
 - working folders 2-942
- vertex color 2-283
- vertex tangent handles - shaping a facial expression target
 - and 2-481
- vertex weights 2-426
- vertices
 - rigid 1-400
- video
 - adding time tags to 3-126
 - synchronizing animation with 3-126
- video post 3-1, 3-14
- viewport background
 - setting up 1-48
- viewport image 2-1
- viewports
 - navigating 3-17
 - setting up background for camera match 3-120
- visibility keys 3-85
- volume fog 3-1
- volume light 3-1

W

- walk
 - creating 1-303
- walk cycle 2-446
- walking
 - stop and start 1-317
- walkthrough 1-276
- water surface shader
 - mental ray 2-871
- weight
 - giving biped illusion of 2-506
- weighted list controllers 1-223, 1-237
- wings, airplane 1-51
- wireframe material controls 1-119

- wiring 1-464
 - character rig 2-317, 2-321, 2-349
 - character rigging 2-391
 - particle systems 1-464
- workbench 2-627
- working online 1-4
- world space mapscaler 1-186
- world-space camera map modifier (WSM) 3-133
- wraparound shader
 - mental ray 2-849
- wrist
 - automatic twist 2-383
 - twist bones 2-345
 - twist rig 2-371

X

- XML files 2-182
- xrefs
 - and animating a spaceship 1-259
 - and merging 2-446

